

PUBLISHED VERSION

G. Aad ... P. Jackson ... L. Lee ... A. Petridis ... N. Soni ... M. J. White ... et al. (ATLAS Collaboration)
Measurement of the cross-section for b-jets produced in association with a Z boson at $\sqrt{s} = 7$ TeV
with the ATLAS detector

Physics Letters B, 2012; 706(4-5):295-313

© 2011 CERN. Published by Elsevier B.V. Open access under CC BY-NC-ND license
[<https://creativecommons.org/licenses/by-nc-nd/4.0/>].

Originally published at:

<http://doi.org/10.1016/j.physletb.2011.11.059>

PERMISSIONS

<http://creativecommons.org/licenses/by-nc-nd/4.0/>



The image shows the Creative Commons Attribution-NonCommercial-NoDerivatives 4.0 International (CC BY-NC-ND 4.0) license logo. It features four icons in a row: the CC logo, a person icon (Attribution), a crossed-out dollar sign (Non-Commercial), and an equals sign (No Derivatives). Below the icons, the text reads "Attribution-NonCommercial-NoDerivatives 4.0 International (CC BY-NC-ND 4.0)".

This is a human-readable summary of (and not a substitute for) the [license](#). [Disclaimer](#).

You are free to:

Share — copy and redistribute the material in any medium or format

The licensor cannot revoke these freedoms as long as you follow the license terms.

Under the following terms:

 **Attribution** — You must give [appropriate credit](#), provide a link to the license, and [indicate if changes were made](#). You may do so in any reasonable manner, but not in any way that suggests the licensor endorses you or your use.

 **NonCommercial** — You may not use the material for [commercial purposes](#).

 **NoDerivatives** — If you [remix, transform, or build upon](#) the material, you may not distribute the modified material.

No additional restrictions — You may not apply legal terms or [technological measures](#) that legally restrict others from doing anything the license permits.

<http://hdl.handle.net/2440/101687>



Measurement of the cross-section for b -jets produced in association with a Z boson at $\sqrt{s} = 7$ TeV with the ATLAS detector[☆]

ATLAS Collaboration^{*}

ARTICLE INFO

Article history:

Received 7 September 2011
 Received in revised form 1 November 2011
 Accepted 26 November 2011
 Available online 1 December 2011
 Editor: H. Weerts

Keywords:

Standard Model
 Z boson
 b -jet
 Cross-section

ABSTRACT

A measurement is presented of the inclusive cross-section for b -jet production in association with a Z boson in pp collisions at a centre-of-mass energy of $\sqrt{s} = 7$ TeV. The analysis uses the data sample collected by the ATLAS experiment in 2010, corresponding to an integrated luminosity of approximately 36 pb^{-1} . The event selection requires a Z boson decaying into high p_T electrons or muons, and at least one b -jet, identified by its displaced vertex, with transverse momentum $p_T > 25$ GeV and rapidity $|y| < 2.1$. After subtraction of background processes, the yield is extracted from the vertex mass distribution of the candidate b -jets. The ratio of this cross-section to the inclusive Z cross-section (the average number of b -jets per Z event) is also measured. Both results are found to be in good agreement with perturbative QCD predictions at next-to-leading order.

© 2011 CERN. Published by Elsevier B.V. Open access under [CC BY-NC-ND license](#).

1. Introduction

The production of Z bosons in association with jets at hadron colliders has long been used as a testing ground for perturbative QCD (pQCD) calculations. However, whilst substantial progress has been made in understanding and modelling the production of inclusive jets in Z events, the production of heavy flavour (b or c) jets is less well studied. The production of one or more b -jets in association with a Z boson is a significant background to many important searches at the LHC, such as the Standard Model Higgs search, SUSY searches and searches for other physics beyond the Standard Model. A measurement of Z plus b -jets production therefore directly improves the understanding of this process, and consequently the ability to accurately model this background.

Fig. 1 shows the main diagrams that contribute to $Z + b$ production. The top two diagrams have an initial state b -quark, whereas in the bottom two diagrams, a $b\bar{b}$ pair is explicitly produced in the final state. The ALPGEN [1] and SHERPA [2] Monte Carlo (MC) generators implement leading order (LO) calculations of this process using massive b -quarks. For the amplitudes with initial b -quarks, ALPGEN first creates a $b\bar{b}$ pair from the distribution of gluons, and integrates over the whole phase space for these quarks. SHERPA, in the present implementation, draws a b -quark from a Parton Density Function (PDF) derived from the gluon distribution. These generators are interfaced to parton shower and hadronisation packages and provide direct comparison to the data. In addition to the diagrams in Fig. 1, it is also possible that the Z boson and

b -jets are produced in two different parton–parton collisions in the same proton–proton interaction. This process, referred to as multiple parton interaction (MPI), is included in the ALPGEN and SHERPA generators. In contrast, the MCFM programme [3] implements next-to-leading order (NLO) calculations [4] using massless b -quarks, with initial b -quarks taken from a b -PDF. MCFM is not interfaced to parton shower/hadronisation packages, and does not include MPI. Calculations of the $Z + b$ process at NLO continue to be an active area of development [5,4,6–8].

Previous measurements of $Z + b$ production at lower centre-of-mass energy $p\bar{p}$ collisions at the Fermilab Tevatron collider by the CDF and D0 Collaborations [9,10] are consistent with pQCD calculations. In this Letter we present a measurement of the inclusive cross-section for b -jet production in association with a Z boson, σ_b . The measurement is made at the particle-level, and is fully corrected for all detector effects. A b -jet is defined here as a jet which contains a b -hadron. Here and in the following, Z stands for both the Z boson and virtual photon γ^* contributions. The Z boson is identified by its decay into a pair of high transverse momentum, opposite sign electrons (electron channel) or muons (muon channel), and the Z and b -jets are reconstructed within the allowed fiducial coverage of the detector. The cross-section σ_b is quoted per lepton channel, within this fiducial coverage. A closely related measurement has been performed, using very similar techniques, in the $W + b$ final state [11].

2. The ATLAS detector

The ATLAS detector [12] consists of an inner tracking system surrounded by a thin superconducting solenoid providing

[☆] © CERN for the benefit of the ATLAS Collaboration.

^{*} E-mail address: atlas.publications@cern.ch.

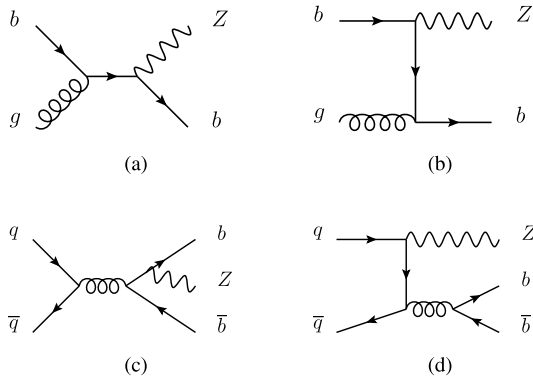

Fig. 1. Main diagrams for associated production of a Z boson and one or more b -jets.

a 2 T axial magnetic field, electromagnetic and hadronic calorimeters and a muon spectrometer. The inner detector system provides tracking information for charged particles in a pseudorapidity range $|\eta| < 2.5$.¹ At small radii, high granularity silicon pixel and microstrip detectors allow for the reconstruction of secondary decay vertices. The electromagnetic calorimeter uses lead absorbers and liquid argon as the active material and covers the rapidity range $|\eta| < 3.2$, with high longitudinal and transverse granularity for electromagnetic shower reconstruction. For electron detection the transition region between the barrel and end-cap calorimeters, $1.37 < |\eta| < 1.52$, is not considered in this analysis. The hadronic tile calorimeter is a steel/scintillating-tile detector that extends the instrumented depth of the calorimeter to fully contain hadronic particle showers. In the forward regions it is complemented by two end-cap calorimeters using liquid argon as the active material and copper or tungsten as the absorber material. The muon spectrometer comprises three large air-core superconducting toroidal magnets which provide a typical field integral of 3 Tm. Three stations of chambers provide precise tracking information in the range $|\eta| < 2.7$, and triggers for high momentum muons in the range $|\eta| < 2.4$. The transverse energy E_T is defined to be $E \sin \theta$, where E is the energy associated with a calorimeter cell or energy cluster. Similarly, p_T is the momentum component transverse to the beam line.

3. Collision data and simulated samples

3.1. Collision data

The analysis presented here is performed on data from pp collisions at a centre-of-mass energy of 7 TeV recorded by ATLAS in 2010 in stable beams periods and uses data selected for good detector performance. The events were selected online by requiring at least one electron or muon with high transverse momentum, p_T . The trigger thresholds evolved with time to keep up with the increasing instantaneous luminosity delivered by the LHC. The highest thresholds applied in the last data taking period were $E_T > 15$ GeV for electrons and $p_T > 13$ GeV for muons. The integrated luminosity after beam, detector and data-quality requirements is 36.2 pb^{-1} (35.5 pb^{-1}) for events collected with the electron (muon) trigger, measured with a $\pm 3.4\%$ relative error [13, 14].

¹ The azimuthal angle ϕ is measured around the beam axis and the polar angle θ is the angle from the beam axis. The pseudorapidity is defined as $\eta = -\ln \tan(\theta/2)$. The distance ΔR in $\eta - \phi$ space is defined as $\Delta R = \sqrt{\Delta\phi^2 + \Delta\eta^2}$.

3.2. Simulated events

The measurements will be compared to theoretical predictions of the Standard Model, using Monte Carlo samples of signal and background processes. The detector response to the generated events is fully simulated with GEANT4 [15].

Samples of signal events containing a Z boson decaying into electrons or muons and at least one b -jet have been simulated using the ALPGEN, SHERPA, and MCFM generators, using the CTEQ6.6 PDF set [16]. All three generators include Z/γ^* interference terms. The ALPGEN generator is interfaced to HERWIG [17] for parton shower and fragmentation, and JIMMY for the underlying event simulation [18]. For jets originating from the hadronisation of light quarks or gluons (hereafter referred to as *light-jets*), the LO generator ALPGEN uses MLM matching [19] to remove any double counting of identical jets produced via the matrix element and parton shower, but this is not available for b -jets in the present version. Therefore events containing two b -quarks with $\Delta R < 0.4$ ($\Delta R > 0.4$) coming from the matrix element (parton shower) contribution are removed. SHERPA uses the CKKW [20] matching for the same purpose. The MCFM NLO generator lacks an interface to a parton shower and fragmentation package, hence to compare with the data we apply correction factors describing the parton-to-particle correspondence, obtained from particle-level LO simulations. For all Monte Carlo events, the cross-section is normalised by rescaling the inclusive Z cross-section of the relevant generator to the NNLO cross-section [21].

The dominant background comes from $Z + \text{jets}$ events, with the Z decaying into electrons, muons or tau leptons, where one jet is a *light* or c -jet which has been incorrectly tagged as a b -jet. These events are simulated using the same generators as the signal. Other background processes considered include $t\bar{t}$ pair production simulated by MC@NLO [22,23], $W(\rightarrow l\nu) + \text{jets}$ simulated by PYTHIA [24], $WW/WZ/ZZ$ simulated by ALPGEN, and single-top production simulated by MC@NLO. The cross-sections for these processes have been normalised to the predictions of [25,26] (approximate NNLO) for $t\bar{t}$ pair production, [21] (NNLO) for $W(\rightarrow l\nu) + \text{jets}$, [3] (NLO) for $WW/WZ/ZZ$, and the MC@NLO value for single-top.

Events have been generated with the number of collision vertices drawn from a Poisson distribution with an average of 2.0 vertices per event. Simulated events are then reweighted to match the observed vertex distribution in the data.

4. Reconstruction and selection of Z + b candidates

Events are required to contain one primary vertex with at least three high-quality charged tracks. As the final state should contain a Z boson, the selection of events closely follows the selection criteria used by ATLAS for the inclusive Z analysis [27]. In the e^+e^- channel, two opposite sign electron candidates are required with $E_T > 20$ GeV and $|\eta| < 2.47$. Electron candidates are reconstructed from a cluster of cells in the electromagnetic calorimeter and a charged particle track in the inner detector. Criteria are applied on the longitudinal and transverse shower shapes in the calorimeters and on the matching of the track with the cell cluster, requesting a *Medium* [27] electron quality. Similarly in the $\mu^+\mu^-$ channel, two opposite sign muons are required with $p_T > 20$ GeV and $|\eta| < 2.4$. Muon candidates are reconstructed from a track in the muon spectrometer associated with a track in the inner detector. To reject cosmic rays the track is required to be compatible with coming from the primary vertex of the collision under study. In addition, an isolation criterion is applied requiring that the summed p_T of tracks in a cone $\Delta R = 0.2$ around the muon candidate be less than 10% of the muon p_T . For both channels, the invariant mass of the

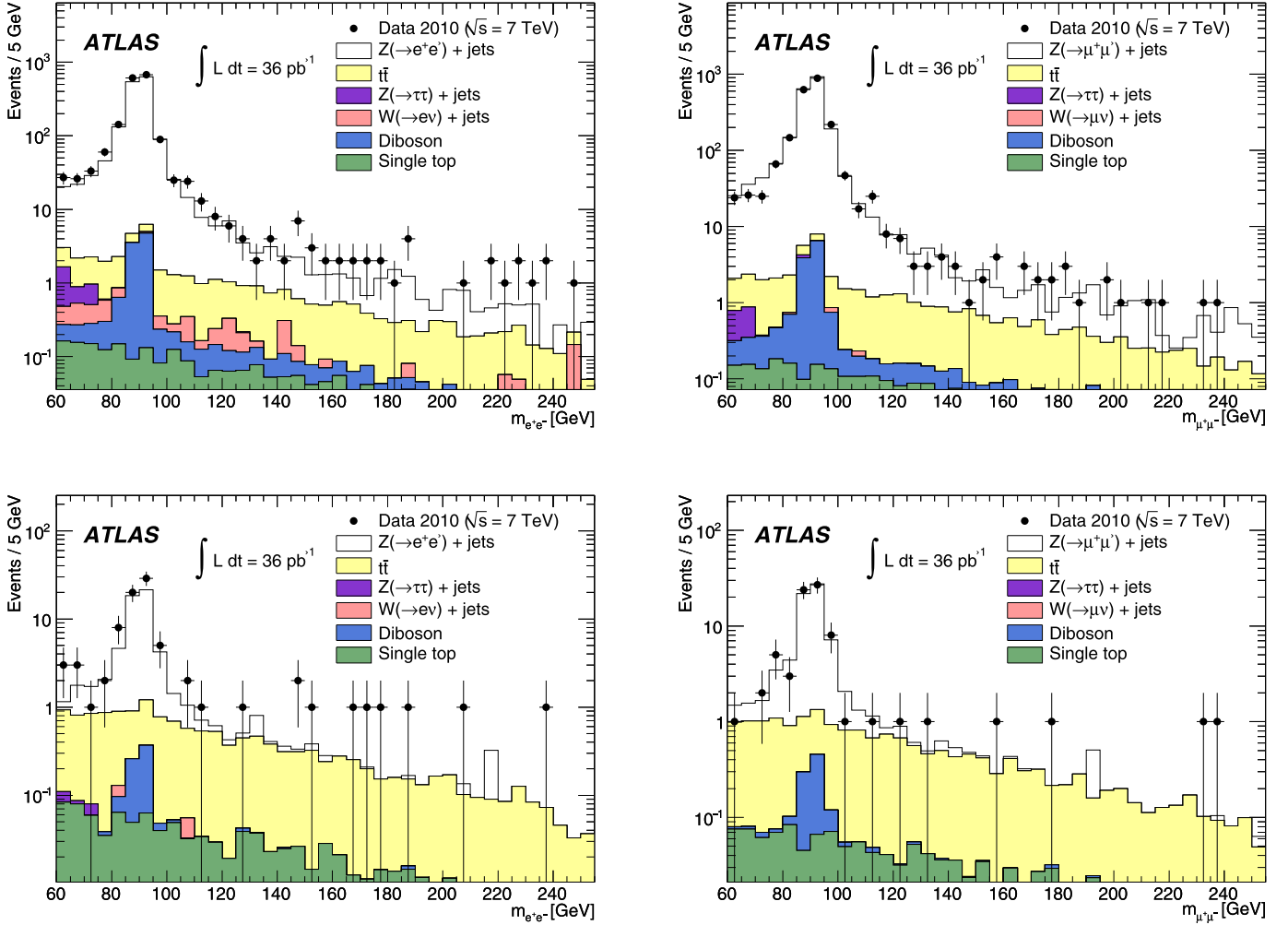

Fig. 2. Top frames: Di-lepton mass distribution for events with at least one jet with $p_T > 25$ GeV and $|y| < 2.1$, for the electron (left) and muon (right) channels. Bottom frames: Di-lepton mass distribution for events with at least one b -tagged jet with $p_T > 25$ GeV and $|y| < 2.1$, for the electron (left) and muon (right) channels. The contribution estimated from the simulated MC samples of the signal and various background processes is shown. The small multi-jet background, estimated with a data-driven method, is not shown here (see text).

lepton pair is then required to be $76 < m_{ll} < 106$ GeV. This window is chosen to be narrower than that used in the inclusive Z analysis in order to reduce the background from $t\bar{t}$ events, and multi-jet events where jets are mis-identified as leptons, either due to a high electromagnetic content in the shower, or mis-reconstruction.

Jets are reconstructed from clusters of electromagnetic and hadronic calorimeter cells using an anti- k_t [28] algorithm with a resolution parameter of 0.4. A jet calibration procedure is applied which includes an energy offset which depends on the number of primary vertices, in order to minimise the impact of additional (pile-up) collisions [29]. The b -jets do not receive any additional calibration, thus their difference in jet energy scale with respect to *light*-jets (2.5% in simulated events) is treated as a systematic uncertainty, discussed in Section 6.2. To avoid double-counting electrons and muons as jets, jets with $\Delta R < 0.5$ to either of the leptons coming from the Z pair are removed. Events are selected requiring at least one jet with $p_T > 25$ GeV and $|y| < 2.1$.

A jet is considered as b -tagged if the SV0 algorithm [30] reconstructs a secondary vertex from charged particle tracks contained within the jet and the decay length significance of this secondary vertex is greater than 5.85. This requirement provides 50% efficiency for tagging b -jets in simulated $t\bar{t}$ events [31]. In addition, the invariant mass of the charged particle tracks from which the

Table 1

The number of events selected at various stages of the analysis event selection.

Electron channel		Muon channel	
Criterion	Events	Criterion	Events
2 selected electrons	10 558	2 selected muons	13 691
Z mass window	9230	Z mass window	12 222
≥ 1 jet	1597	≥ 1 jet	1987
≥ 1 b -tag	64	≥ 1 b -tag	67
$= 1$ b -tag	62	$= 1$ b -tag	63
$= 2$ b -tag	1	$= 2$ b -tag	4
$= 3$ b -tag	1	$= 3$ b -tag	0

secondary vertex is reconstructed – the SV0-mass – will be used to extract the b -jet fraction on a statistical basis. Table 1 gives the number of data events selected by the consecutive stages of the analysis.

5. Background subtraction and signal yield determination

5.1. Background estimation

The main background of Z + *light*-jets and Z + c -jets is taken into account via the signal yield extraction procedure described

below. However, a number of other background processes can contribute, namely $t\bar{t}$ with two leptonic decays of the W bosons, W + jets with one jet being mis-identified as an electron or muon, Z + jets with the Z boson decaying to $\tau\tau$, dibosons $WW/WZ/ZZ$, single-top production, and finally multi-jet production where the jets contain real leptons from heavy flavour decays or are mis-identified as leptons. The background processes other than that from multi-jets are estimated from the MC simulation samples described in Section 3.2, resulting in the following contributions to each channel after implementation of the analysis jet selection criteria: $t\bar{t}$ (~ 6 tagged jets), WZ (~ 0.2), ZZ (~ 0.3), single-top (~ 0.3), and $Z \rightarrow \tau\tau$ (~ 0.1). In Fig. 2, the top two frames show the di-lepton mass distribution for events with at least one jet with $p_T > 25$ GeV and $|y| < 2.1$ for the electron and muon channels, together with the simulation broken down into signal and background processes, not including the multi-jet background. In the same figure, the bottom two frames show the same distribution after requesting at least one jet that is b -tagged by the SV0 algorithm.

The multi-jet background cannot be extracted reliably from simulation, and hence is estimated using data-driven methods. In the electron channel, the method considers two different samples of electron candidates with relaxed selection criteria. In the first sample the selection criteria on one of the electrons are significantly relaxed, while in the second sample, the criteria on both electrons are mildly relaxed but *Medium* electrons are vetoed. In these samples, the di-electron mass spectrum is fitted with two components: the contribution of the signal and other background processes modelled by the simulated MC samples (with relative signal/background normalisation fixed by the MC predictions), and an exponential function which was found to model the multi-jet contribution well. The fit parameters are the normalisation of the MC component, and the normalisation and exponent of the multi-jet exponential. To determine the multi-jet background the fit is repeated, but this time using the di-electron spectrum of events passing the full analysis selection, and again allowing the normalisation of the MC component and multi-jet background to float, but fixing the exponent of the multi-jet exponential to the value determined from the relaxed selection samples. The extracted exponents are similar for the two samples of relaxed electron candidates, leading to the same estimated contribution of multi-jet events: (1.0 ± 2.2) events in the mass window $76 < m_{ll} < 106$ GeV. In the muon channel the method considers a sample of events similar to the signal but with non-isolated muon candidates, which has been shown to be dominated by the multi-jet background. The multi-jet background contribution to the signal is then estimated assuming that the ratio of the number of events with isolated muons to that with non-isolated muons is the same in the data as in the simulated multi-jet MC sample, and amounts to (0.0 ± 0.9) events.

5.2. Signal yield

The jets that are b -tagged by the SV0 algorithm still contain *light* and c -jets. The yield of b -jets is thus calculated on a statistical basis, by fitting the expected contributions to the SV0-mass distribution. For the electron and muon channels, templates are obtained from the simulation for the SV0-mass spectrum of each contribution: signal $Z + b$ -jets, $Z + light$ jets, $Z + c$ -jets, and all other background processes ($t\bar{t}$, multi-jet, single-top, W + jets, $Z \rightarrow \tau^+\tau^-$ and diboson). As the templates for the electron and muon channels are compatible, these channels are treated together and both types of events are entered into one SV0-mass distribution. This spectrum is subjected to a likelihood fit, consisting of a sum containing the fixed contributions of the other back-

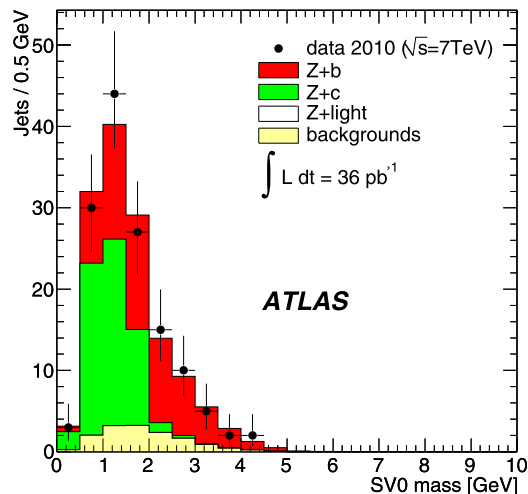

Fig. 3. SV0-mass distribution (see text) for b -tagged jets in the selected events. The fitted contributions from b , *light*, and c -jets are displayed; the other background processes are also shown.

Table 2

Number of jets for the various flavors in the combined electron and muon channel, determined from the fit to the SV0-mass distribution. The statistical errors on the fit results are given.

b -jets	$63.6^{+14.7}_{-13.2}$
c -jets	$59.9^{+13.4}_{-14.0}$
<i>light</i> jets	$0.0^{+5.1}$
other backgrounds (fixed)	14.5

ground processes and a floating amount of $Z + b$, $Z + light$, and $Z + c$ -jets. In order to validate the fit procedure, we performed fit closure and linearity tests using pseudo-experiments. In each pseudo-experiment, SV0-mass distributions are constructed using the templates with the same number of events as in the data and varying proportions of the b -jet template, then the fit procedure is performed. The results demonstrated good linearity and no bias. Fig. 3 shows the SV0-mass spectrum of b -jet candidates with the fitted contributions, and Table 2 gives the corresponding number of jets. The purity of the b -tagged sample is therefore found to be about 46% with this selection.

6. Cross-section measurement and comparison to theory

6.1. Unfolding to the particle level

The particle-level cross-section, σ_b , is defined as follows. The fiducial restrictions on the Z decay are defined as lepton $p_T > 20$ GeV and $|\eta| < 2.5$, and di-lepton mass pair within the range $76 < m_{ll} < 106$ GeV. In this definition, “dressed” leptons are used to reconstruct the Z [32]: the four-vectors of all photons in a cone of $\Delta R < 0.1$ around the lepton are added to the lepton four-vector. Jets are reconstructed from stable particles (particles with lifetime in excess of 10 ps) using the anti- k_t algorithm with resolution parameter of 0.4, and include muons and neutrinos. Jets are required to satisfy $p_T > 25$ GeV and $|y| < 2.1$, and jets within $\Delta R < 0.5$ of either of the Z decay leptons are removed. At particle-level, a jet is considered to be a b -jet if there is a b -hadron with $p_T > 5$ GeV within $\Delta R < 0.3$ of that jet, and only weakly-decaying b -hadrons are considered.

The per lepton channel cross-section is obtained from the experimental measurements using the following formula:

$$\sigma_b = \frac{N_b}{C_e \mathcal{L}_e + C_\mu \mathcal{L}_\mu}$$

where N_b is the number of b -jets extracted from the fit to the SV0-mass distribution of b -tagged jets (given in Table 2), C_e and C_μ are the acceptance factors for the electron and muon channels respectively, and \mathcal{L}_e and \mathcal{L}_μ are the respective integrated luminosities for each channel.

The C_e and C_μ acceptance factors are determined from the simulated MC samples of the signal process, and correspond to the probability that a particle-level b -jet in a Z event as defined above passes all of the jet and Z event selection criteria at the detector-level. They thus include the efficiency for a signal event to pass the triggers used, the efficiency to reconstruct electrons or muons, and the efficiency of the SV0 algorithm to tag b -jets. The efficiencies of the electron and muon high p_T triggers have been studied with data, and for signal events in the acceptance defined above the trigger efficiency is found to be in excess of 99% for both electron and muon channels. In the determination of the lepton and b -tagging efficiencies, scale factors to account for mis-modelling by the simulation are applied. In the case of electron and muon reconstruction, these scale factors are determined using inclusive Z and W events in data [27,33], and are found to be close to unity at the few percent level. For the SV0 b -tagging efficiency, the scale factors have been determined as a function of jet p_T and η using data events where the jet contains a reconstructed muon to enrich the b component [31], and are found to be consistent with unity. The uncertainty related to these scale factors is propagated into the final uncertainty on the cross-section.

6.2. Systematic uncertainties

The systematic uncertainties on the measured fiducial b -jet cross-section are summarised in Table 3. A systematic source can impact the measurement in two ways: it can affect the SV0-mass template shapes and hence the fitted N_b , and/or it can affect the calculated acceptance factors (C_e and/or C_μ). Where a systematic affects both the fit result and the acceptance the corresponding correlations have been taken into account.

The dominant source of systematic uncertainty comes from the dependence of the measurement on the modelling of the signal process in the simulation. The calculated acceptance factors and SV0-mass template shapes both depend on the assumed b -jet p_T spectrum. The sensitivity to the p_T spectrum modelling in simulation is assessed by reweighting the p_T spectrum of the simulation until a satisfactory agreement with data in the p_T spectrum of b -tagged jets was observed. The resulting uncertainty is considerably larger than any differences observed between ALPGEN and SHERPA in the SV0-mass fit results and acceptance factors. In addition, we ascribe a small uncertainty due to the modelling of MPI in the signal simulation, assessed by artificially doubling the contribution of MPI events in the acceptance calculation.

In terms of the reconstruction of b -jets, the main systematics enter via the uncertainty on the b -tagging efficiency scale factors, and uncertainty on the jet energy scale (JES). The uncertainty on the b -tagging scale factors is estimated from studies of inclusive b -jets and b semi-leptonic decays [31]. The JES was studied extensively for inclusive jets using simulations, single hadron test-beam data and γ -jet events [29]. Its uncertainty was demonstrated to be below 5% in the p_T range considered here. In simulation, the JES for b -jets was found to differ from that of *light* jets by at most 2.5%. The present statistics do not allow us to calibrate this difference from the data, hence an additional 2.5% is added in quadrature to the JES uncertainty of b -jets. The jet energy resolution was also considered and the uncertainty taken as that derived from

Table 3

Fractional systematic uncertainties on the SV0-mass fit and acceptance results from each systematic source considered. Sources for which the shift is labelled “negl.” produced effects of less than 1% which are negligible when added in quadrature (and not considered). When relevant, asymmetric errors are used for the calculation of the total, but only the average error is shown for better readability. The “Total Systematic Uncertainty” result is the total percentage error on the combined channel b -jet cross-section, and takes into account the correlations between SV0-mass fit and acceptance systematics.

Source	SV0-mass fit (%)	Acceptance (%)
Both electron and muon		
b -Tagging efficiency	1.7	9.1
SV0-mass templates	3.5	–
Model dependence	2.7	10.0
Jet energy scale	0.7	4.0
$t\bar{t}$ cross-section	2.0	–
MPI model	negl.	1.0
Electron only		
MC statistics	negl.	1.3
Multi-jet background	1.6	–
Electron efficiency	negl.	5.0
Total electron	5.6	15.0
Muon only		
MC statistics	negl.	1.3
Multi-jet background	0.7	–
Muon efficiency	negl.	2.0
Total muon	5.4	14.3
Total Systematic Uncertainty	+21% –16%	

light jets. One also has to consider that the detector simulation may not perfectly model the response to the SV0-mass distribution for *light*, c , and b -jets. This uncertainty is estimated using control samples of inclusive jet events that are enriched in heavy and light flavour jets, and used to derive reweighting functions that can be applied to the SV0-mass templates to account for data-simulation disagreements.

The impact of uncertainties in the background estimation are small. The $t\bar{t}$ background is estimated purely from simulation, and the normalisation of this background is varied according to the uncertainty on the NNLO $t\bar{t}$ cross-section. The multi-jet backgrounds in both the electron and muon channel are varied according to the uncertainties on these estimates described above.

Other smaller sources of systematic uncertainty considered include uncertainties on lepton reconstruction: the efficiency to reconstruct, and the energy/momentum scale and resolution. The estimation follows closely that of the inclusive Z analysis [27], with the same methods applied to simulated $Z + b$ event samples. The uncertainties on the electromagnetic energy scale, and on the muon momentum scale and resolution, all have a negligible (< 1%) impact.

6.3. Results and comparison to theory

The measured cross-section for b -jets produced in association with a Z boson decaying into one of the lepton channels is presented in Table 4, alongside values evaluated in the different models presented in the introduction. The MCFM NLO prediction is shown for the CTEQ6.6 PDF, with the renormalisation and factorisation scales taken as $\sqrt{M_Z^2 + p_{T,Z}^2}$. In contrast to ALPGEN and SHERPA, MCFM does not simulate QED final state radiation (FSR) nor non-perturbative hadronic effects. Correction factors are computed for lepton FSR, parton/jet correspondence, underlying event and MPI contribution, using events from particle-level LO simulations. The correction factor for non-perturbative hadronic effects is obtained by comparing particle-level results to parton-level, where

Table 4

Experimental measurement and predictions of σ_b , the cross-section for inclusive b -jet production in association with a Z boson, per lepton channel, as defined in the text.

Experiment	$3.55^{+0.82}_{-0.74}(\text{stat})^{+0.73}_{-0.55}(\text{syst}) \pm 0.12(\text{lumi})$ pb
MCFM	3.88 ± 0.58 pb
ALPGEN	2.23 ± 0.01 (stat only) pb
SHERPA	3.29 ± 0.04 (stat only) pb

parton-level jets are matched to b quarks. This is calculated using SHERPA, PYTHIA and AcerMC [34], with the spread of these results defining the range of the correction, which is found to be 0.89 ± 0.07 . The correction is dominated by the impact of b -hadron decay products falling outside the jet at the particle-level. The correction factor for lepton FSR is similarly found to be 0.972 ± 0.002 for both lepton types, dominated by dilepton pairs migrating out of the required mass window.

In order to estimate theoretical uncertainties on the prediction, the renormalisation and factorisation scales are independently shifted up, then down, by a factor of 2. The uncertainties arising from the different PDF error sets are also assessed, as well as using the CTEQ6.6 PDF with different values of α_s . The raw MCFM prediction for the $Z + b$ cross-section in the fiducial region is $4.48^{+0.55}_{-0.56}(\text{scale})^{+0.10}_{-0.12}(\text{PDF})^{+0.08}_{-0.08}(\alpha_s)$ pb. For comparison, the prediction obtained using the MSTW2008 PDF [35] is $4.80^{+0.62}_{-0.61}(\text{scale})^{+0.09}_{-0.10}(\text{PDF})^{+0.09}_{-0.11}(\alpha_s)$ pb. The CTEQ6.6 and MSTW2008 PDFs use different default values for α_s (propagated consistently through the NLO calculation), and, taking into account their combined PDF and α_s uncertainties, there is a marginal disagreement between the two predictions. However, given the precision of the experimental measurement, we cannot conclude that one PDF better reproduces the experimental result than the other. We quote the prediction using the CTEQ6.6 PDF by default, and the uncertainty quoted in Table 4 for the corrected result corresponds to the quadratic sum of the uncertainties on the scale, PDF, α_s , and the uncertainty on the non-perturbative correction. The ALPGEN and SHERPA predictions are also shown, with errors from the MC statistics only.

6.4. Measurement of the average number of b -jets per Z event

Simulation packages such as ALPGEN and SHERPA are based on LO calculations and thus are not expected to accurately predict an absolute cross-section for the process studied here. However, they are often used to generate fully simulated events for the study of backgrounds to the search of other processes, as mentioned in the introduction. A current practice is then to normalise the cross-section of generated events to that of a well-known, more inclusive process. In this approach, the analysis presented here is extended to measure the ratio of σ_b to that of the cross-section for the inclusive production of the Z boson (for the same fiducial restrictions on the Z decay), i.e. the average number of b -jets per Z event. To obtain the inclusive Z sample, the analysis is repeated with the same selection as above, except the jet requirements. The cross-section obtained for the inclusive Z production with the same fiducial region for the leptons is 465 ± 3 pb (statistical error only), in agreement with the ATLAS measurement [36]. The systematic uncertainties on the ratio are propagated coherently in the $Z + b$ and Z selections. The uncertainties related to leptons cancel to a negligible level, and those related to luminosity cancel completely. However as the main systematic uncertainties concern only the $Z + b$ analysis (b -tagging, model dependence, jet energy scale), the overall systematic uncertainty is only marginally reduced.

The MCFM prediction of this ratio is calculated with the same method and assumptions as above. To estimate the systematic un-

Table 5

Experimental measurement and predictions of the average number of b -jets produced in association with a Z boson, with the same fiducial region as defined in the text for σ_b .

Experiment	$(7.6^{+1.8}_{-1.6}(\text{stat})^{+1.5}_{-1.2}(\text{syst})) \times 10^{-3}$
MCFM	$(8.8 \pm 1.1) \times 10^{-3}$
ALPGEN	$(6.2 \pm 0.1$ (stat only)) $\times 10^{-3}$
SHERPA	$(9.3 \pm 0.1$ (stat only)) $\times 10^{-3}$

certainty, the scale and PDF choices are varied coherently between the $Z + b$ and inclusive Z samples for each sub-process simulated. Table 5 shows the experimentally measured result for the average number of b -jets per Z event and comparisons to the theoretical predictions. The MCFM NLO prediction is in agreement with the data. The ALPGEN and SHERPA predictions differ significantly from each other, but are both compatible with the data within the experimental uncertainties.

7. Conclusions

A first measurement is made of the cross-section for the production of b -jets in association with a Z boson in proton–proton collisions at $\sqrt{s} = 7$ TeV, using 36 pb^{-1} of data collected in 2010 by the ATLAS experiment. In addition, the average number of b -jets per Z event is extracted. Both measurements are currently statistics limited. The predictions from NLO pQCD calculations agree well with both results. Leading order generators are able to reproduce the measured average number of b -jets per Z event within the uncertainties of the measurement, although their predictions differ significantly from each other.

Acknowledgements

We thank CERN for the very successful operation of the LHC, as well as the support staff from our institutions without whom ATLAS could not be operated efficiently.

We acknowledge the support of ANPCyT, Argentina; YerPhI, Armenia; ARC, Australia; BMWF, Austria; ANAS, Azerbaijan; SSTC, Belarus; CNPq and FAPESP, Brazil; NSERC, NRC and CFI, Canada; CERN; CONICYT, Chile; CAS, MOST and NSFC, China; COLCIENCIAS, Colombia; MSMT CR, MPO CR and VSC CR, Czech Republic; DNRF, DNSRC and Lundbeck Foundation, Denmark; ARTEMIS, European Union; IN2P3-CNRS, CEA-DSM/IRFU, France; GNAS, Georgia; BMBF, DFG, HGF, MPG and AvH Foundation, Germany; GSRT, Greece; ISF, MINERVA, GIF, DIP and Benoziyo Center, Israel; INFN, Italy; MEXT and JSPS, Japan; CNRST, Morocco; FOM and NWO, Netherlands; RCN, Norway; MNiSW, Poland; GRICES and FCT, Portugal; MERYS (MECTS), Romania; MES of Russia and ROSATOM, Russian Federation; JINR; MSTU, Serbia; MSSR, Slovakia; ARRS and MVZT, Slovenia; DST/NRF, South Africa; MICINN, Spain; SRC and Wallenberg Foundation, Sweden; SER, SNSF and Cantons of Bern and Geneva, Switzerland; NSC, Taiwan; TAEK, Turkey; STFC, the Royal Society and Leverhulme Trust, United Kingdom; DOE and NSF, United States of America.

The crucial computing support from all WLCG partners is acknowledged gratefully, in particular from CERN and the ATLAS Tier-1 facilities at TRIUMF (Canada), NDGF (Denmark, Norway, Sweden), CC-IN2P3 (France), KIT/GridKA (Germany), INFN-CNAF (Italy), NL-T1 (Netherlands), PIC (Spain), ASGC (Taiwan), RAL (UK) and BNL (USA) and in the Tier-2 facilities worldwide.

Open access

This article is published Open Access at sciencedirect.com. It is distributed under the terms of the Creative Commons Attribution

tion License 3.0, which permits unrestricted use, distribution, and reproduction in any medium, provided the original authors and source are credited.

References

- [1] M. Mangano, et al., JHEP 0307 (2003) 001, ALPGEN version 2.13 is used.
- [2] T. Gleisberg, et al., JHEP 0902 (2009) 007, SHERPA version 1.1.3 is used.
- [3] J.M. Campbell, R. Ellis, Nucl. Phys. (Proc. Suppl.) 205–206 (2010) 10, MCFM version 5.8 is used.
- [4] J. Campbell, R. Ellis, F. Maltoni, S. Willenbrock, Phys. Rev. D 69 (2004) 074021.
- [5] J. Campbell, R. Ellis, Phys. Rev. D 62 (2000) 114012.
- [6] J. Campbell, R. Ellis, F. Maltoni, S. Willenbrock, Phys. Rev. D 73 (2006) 054007.
- [7] F.F. Cordero, L. Reina, D. Wackerroth, Phys. Rev. D 80 (2009) 034015.
- [8] R. Frederix, et al., W and Z/γ^* boson production in association with a bottom–antibottom pair, arXiv:1106.6019 [hep-ph], 2011.
- [9] CDF Collaboration, Phys. Rev. D 79 (2009) 052008.
- [10] D0 Collaboration, Phys. Rev. D 83 (2011) 031105.
- [11] ATLAS Collaboration, Measurement of the cross section for the production of a W boson in association with b -jets in pp collisions at $\sqrt{s} = 7$ TeV with the ATLAS detector, Phys. Lett. B (2011), submitted for publication, arXiv:1109.1470 [hep-ex].
- [12] ATLAS Collaboration, JINST 3 (2008) S08003.
- [13] ATLAS Collaboration, Eur. Phys. J. C 71 (2011) 1630.
- [14] ATLAS Collaboration, Updated luminosity determination in pp collisions at $\sqrt{s} = 7$ TeV using the ATLAS detector, ATLAS-CONF-2011-011, 2011, <http://cdsweb.cern.ch/record/1334563>.
- [15] S. Agostinelli, et al., Nucl. Instrum. Meth. A 506 (2003) 250.
- [16] P.M. Nadolsky, et al., Phys. Rev. D 78 (2008) 013004.
- [17] G. Corcella, et al., JHEP 0101 (2001) 010.
- [18] J.M. Butterworth, J.R. Forshaw, M. Seymour, Z. Phys. C 72 (1996) 637, HERWIG version 6.510 is used.
- [19] S. Hoeche, et al., Matching parton showers and matrix elements, in: Proc. of the HERA and the LHC Workshop CERN-DESY, 2006, arXiv:hep-ph/0602031.
- [20] S. Catani, F. Krauss, R. Kuhn, B.R. Webber, JHEP 0111 (2001) 063.
- [21] C. Anastasiou, L.J. Dixon, K. Melnikov, F. Petriello, Phys. Rev. D 69 (2004) 094008.
- [22] S. Frixione, B. Webber, JHEP 0206 (2002) 029.
- [23] S. Frixione, P. Nason, B. Webber, JHEP 0308 (2003) 007, MC@NLO version 3.1.3.1 is used.
- [24] T. Sjostrand, et al., JHEP 0605 (2006) 026, PYTHIA version 6.421 is used.
- [25] S. Moch, P. Uwer, Phys. Rev. D 78 (2008) 034003.
- [26] U. Langenfeld, S. Moch, P. Uwer, New results for $t\bar{t}$ production at hadron colliders, in: Proc. XVII Int. Workshop on Deep-Inelastic Scattering and Related Topics, 2009, arXiv:0907.2527 [hep-ph].
- [27] ATLAS Collaboration, JHEP 1012 (2010) 060.
- [28] M. Cacciari, G. Salam, G. Soyez, J. High Energy Physics 2008 (2008) 063.
- [29] ATLAS Collaboration, Jet energy scale and its systematic uncertainty in proton–proton collisions at $\sqrt{s} = 7$ TeV in ATLAS 2010 data, ATLAS-CONF-2011-032, 2011, <http://cdsweb.cern.ch/record/1337782>.
- [30] ATLAS Collaboration, Performance of the ATLAS secondary vertex b -tagging algorithm in 7 TeV collision data, ATLAS-CONF-2010-042, 2010, <http://cdsweb.cern.ch/record/1277682>.
- [31] ATLAS Collaboration, Calibrating the b -tag efficiency and mistag rate in 35 pb^{-1} of data with the ATLAS detector, ATLAS-CONF-2011-089, 2011, <http://cdsweb.cern.ch/record/1356198>.
- [32] J.M. Butterworth, et al., The tools and Monte Carlo working group summary report, 2010, Sect. 14, arXiv:1003.1643 [hep-ph].
- [33] ATLAS Collaboration, Electron performance measurements with the ATLAS detector using the 2010 LHC proton–proton collision data, Eur. Phys. J. C (2011), submitted for publication, arXiv:1110.3174 [hep-ex].
- [34] B.P. Kersevan, E. Richter-Was, hep-ph/0405247, 2004, AcerMC version 3.8 was used.
- [35] A. Martin, W. Stirling, R. Thorne, G. Watt, Eur. Phys. J. C 63 (2009) 189.
- [36] ATLAS Collaboration, A measurement of the inclusive W^\pm and Z/γ^* cross sections in the e and μ decay channels in pp collisions at $\sqrt{s} = 7$ TeV with the ATLAS detector, Phys. Rev. D (2011), in press, arXiv:1109.5141 [hep-ex].

ATLAS Collaboration

G. Aad⁴⁸, B. Abbott¹¹¹, J. Abdallah¹¹, A.A. Abdelalim⁴⁹, A. Abdesselam¹¹⁸, O. Abidinov¹⁰, B. Abi¹¹², M. Abolins⁸⁸, H. Abramowicz¹⁵³, H. Abreu¹¹⁵, E. Acerbi^{89a,89b}, B.S. Acharya^{164a,164b}, D.L. Adams²⁴, T.N. Addy⁵⁶, J. Adelman¹⁷⁵, M. Aderholz⁹⁹, S. Adomeit⁹⁸, P. Adragna⁷⁵, T. Adye¹²⁹, S. Aefsky²², J.A. Aguilar-Saavedra^{124b,a}, M. Aharrouche⁸¹, S.P. Ahlen²¹, F. Ahles⁴⁸, A. Ahmad¹⁴⁸, M. Ahsan⁴⁰, G. Aielli^{133a,133b}, T. Akdogan^{18a}, T.P.A. Åkesson⁷⁹, G. Akimoto¹⁵⁵, A.V. Akimov⁹⁴, A. Akiyama⁶⁷, M.S. Alam¹, M.A. Alam⁷⁶, J. Albert¹⁶⁹, S. Albrand⁵⁵, M. Aleksa²⁹, I.N. Aleksandrov⁶⁵, F. Alessandria^{89a}, C. Alexa^{25a}, G. Alexander¹⁵³, G. Alexandre⁴⁹, T. Alexopoulos⁹, M. Alhroob²⁰, M. Aliev¹⁵, G. Alimonti^{89a}, J. Alison¹²⁰, M. Aliyev¹⁰, P.P. Allport⁷³, S.E. Allwood-Spiers⁵³, J. Almond⁸², A. Aloisio^{102a,102b}, R. Alon¹⁷¹, A. Alonso⁷⁹, M.G. Alviggi^{102a,102b}, K. Amako⁶⁶, P. Amaral²⁹, C. Amelung²², V.V. Ammosov¹²⁸, A. Amorim^{124a,b}, G. Amorós¹⁶⁷, N. Amram¹⁵³, C. Anastopoulos²⁹, L.S. Ancu¹⁶, N. Andari¹¹⁵, T. Andeen³⁴, C.F. Anders²⁰, G. Anders^{58a}, K.J. Anderson³⁰, A. Andreazza^{89a,89b}, V. Andrei^{58a}, M.-L. Andrieux⁵⁵, X.S. Anduaga⁷⁰, A. Angerami³⁴, F. Anghinolfi²⁹, N. Anjos^{124a}, A. Annovi⁴⁷, A. Antonaki⁸, M. Antonelli⁴⁷, A. Antonov⁹⁶, J. Antos^{144b}, F. Anulli^{132a}, S. Aoun⁸³, L. Aperio Bella⁴, R. Apolle^{118,c}, G. Arabidze⁸⁸, I. Aracena¹⁴³, Y. Arai⁶⁶, A.T.H. Arce⁴⁴, J.P. Archambault²⁸, S. Arfaoui^{29,d}, J.-F. Arguin¹⁴, E. Arik^{18a,*}, M. Arik^{18a}, A.J. Armbruster⁸⁷, O. Arnaez⁸¹, C. Arnault¹¹⁵, A. Artamonov⁹⁵, G. Artoni^{132a,132b}, D. Arutinov²⁰, S. Asai¹⁵⁵, R. Asfandiyarov¹⁷², S. Ask²⁷, B. Åsman^{146a,146b}, L. Asquith⁵, K. Assamagan²⁴, A. Astbury¹⁶⁹, A. Astvatsatourov⁵², G. Atoian¹⁷⁵, B. Aubert⁴, E. Auge¹¹⁵, K. Augsten¹²⁷, M. Aurousseau^{145a}, N. Austin⁷³, G. Avolio¹⁶³, R. Avramidou⁹, D. Axen¹⁶⁸, C. Ay⁵⁴, G. Azuelos^{93,e}, Y. Azuma¹⁵⁵, M.A. Baak²⁹, G. Baccaglioni^{89a}, C. Bacci^{134a,134b}, A.M. Bach¹⁴, H. Bachacou¹³⁶, K. Bachas²⁹, G. Bachy²⁹, M. Backes⁴⁹, M. Backhaus²⁰, E. Badescu^{25a}, P. Bagnaia^{132a,132b}, S. Bahinipati², Y. Bai^{32a}, D.C. Bailey¹⁵⁸, T. Bain¹⁵⁸, J.T. Baines¹²⁹, O.K. Baker¹⁷⁵, M.D. Baker²⁴, S. Baker⁷⁷, E. Banas³⁸, P. Banerjee⁹³, Sw. Banerjee¹⁷², D. Banfi²⁹, A. Bangert¹³⁷, V. Bansal¹⁶⁹, H.S. Bansil¹⁷, L. Barak¹⁷¹, S.P. Baranov⁹⁴, A. Barashkou⁶⁵, A. Barbaro Galtieri¹⁴, T. Barber²⁷, E.L. Barberio⁸⁶, D. Barberis^{50a,50b}, M. Barbero²⁰, D.Y. Bardin⁶⁵, T. Barillari⁹⁹, M. Barisonzi¹⁷⁴, T. Barklow¹⁴³, N. Barlow²⁷, B.M. Barnett¹²⁹, R.M. Barnett¹⁴, A. Baroncelli^{134a}, G. Barone⁴⁹, A.J. Barr¹¹⁸, F. Barreiro⁸⁰, J. Barreiro Guimarães da Costa⁵⁷, P. Barrillon¹¹⁵, R. Bartoldus¹⁴³,

A.E. Barton⁷¹, D. Bartsch²⁰, V. Bartsch¹⁴⁹, R.L. Bates⁵³, L. Batkova^{144a}, J.R. Batley²⁷, A. Battaglia¹⁶,
 M. Battistin²⁹, G. Battistoni^{89a}, F. Bauer¹³⁶, H.S. Bawa^{143f}, B. Beare¹⁵⁸, T. Beau⁷⁸, P.H. Beauchemin¹¹⁸,
 R. Beccherle^{50a}, P. Bechtle⁴¹, H.P. Beck¹⁶, M. Beckingham⁴⁸, K.H. Becks¹⁷⁴, A.J. Beddall^{18c},
 A. Beddall^{18c}, S. Bedikian¹⁷⁵, V.A. Bednyakov⁶⁵, C.P. Bee⁸³, M. Begel²⁴, S. Behar Harpaz¹⁵²,
 P.K. Behera⁶³, M. Beimforde⁹⁹, C. Belanger-Champagne⁸⁵, P.J. Bell⁴⁹, W.H. Bell⁴⁹, G. Bella¹⁵³,
 L. Bellagamba^{19a}, F. Bellina²⁹, M. Bellomo²⁹, A. Belloni⁵⁷, O. Beloborodova¹⁰⁷, K. Belotskiy⁹⁶,
 O. Beltramello²⁹, S. Ben Ami¹⁵², O. Benary¹⁵³, D. Bencheekroun^{135a}, C. Benchouk⁸³, M. Bendel⁸¹,
 N. Benekos¹⁶⁵, Y. Benhammou¹⁵³, D.P. Benjamin⁴⁴, M. Benoit¹¹⁵, J.R. Bensinger²², K. Benslama¹³⁰,
 S. Bentvelsen¹⁰⁵, D. Berge²⁹, E. Bergeaas Kuutmann⁴¹, N. Berger⁴, F. Berghaus¹⁶⁹, E. Berglund⁴⁹,
 J. Beringer¹⁴, K. Bernardet⁸³, P. Bernat⁷⁷, R. Bernhard⁴⁸, C. Bernius²⁴, T. Berry⁷⁶, A. Bertin^{19a,19b},
 F. Bertinelli²⁹, F. Bertolucci^{122a,122b}, M.I. Besana^{89a,89b}, N. Besson¹³⁶, S. Bethke⁹⁹, W. Bhimji⁴⁵,
 R.M. Bianchi²⁹, M. Bianco^{72a,72b}, O. Biebel⁹⁸, S.P. Bieniek⁷⁷, K. Bierwagen⁵⁴, J. Biesiada¹⁴,
 M. Biglietti^{134a,134b}, H. Bilokon⁴⁷, M. Bindi^{19a,19b}, S. Binet¹¹⁵, A. Bingul^{18c}, C. Bini^{132a,132b},
 C. Biscarat¹⁷⁷, U. Bitenc⁴⁸, K.M. Black²¹, R.E. Blair⁵, J.-B. Blanchard¹¹⁵, G. Blanchot²⁹, T. Blazek^{144a},
 C. Blocker²², J. Blocki³⁸, A. Blondel⁴⁹, W. Blum⁸¹, U. Blumenschein⁵⁴, G.J. Bobbink¹⁰⁵,
 V.B. Bobrovnikov¹⁰⁷, S.S. Bocchetta⁷⁹, A. Bocci⁴⁴, C.R. Boddy¹¹⁸, M. Boehler⁴¹, J. Boek¹⁷⁴, N. Boelaert³⁵,
 S. Böser⁷⁷, J.A. Bogaerts²⁹, A. Bogdanchikov¹⁰⁷, A. Bogouch^{90,*}, C. Bohm^{146a}, V. Boisvert⁷⁶, T. Bold^{163.g},
 V. Boldea^{25a}, N.M. Bolnet¹³⁶, M. Bona⁷⁵, V.G. Bondarenko⁹⁶, M. Bondioli¹⁶³, M. Boonekamp¹³⁶,
 G. Boorman⁷⁶, C.N. Booth¹³⁹, S. Bordoni⁷⁸, C. Borer¹⁶, A. Borisov¹²⁸, G. Borissov⁷¹, I. Borjanovic^{12a},
 S. Borroni^{132a,132b}, K. Bos¹⁰⁵, D. Boscherini^{19a}, M. Bosman¹¹, H. Boterenbrood¹⁰⁵, D. Botterill¹²⁹,
 J. Bouchami⁹³, J. Boudreau¹²³, E.V. Bouhova-Thacker⁷¹, C. Bourdarios¹¹⁵, N. Bousson⁸³, A. Boveia³⁰,
 J. Boyd²⁹, I.R. Boyko⁶⁵, N.I. Bozhko¹²⁸, I. Bozovic-Jelisavcic^{12b}, J. Bracinik¹⁷, A. Braem²⁹,
 P. Branchini^{134a}, G.W. Brandenburg⁵⁷, A. Brandt⁷, G. Brandt¹⁵, O. Brandt⁵⁴, U. Bratzler¹⁵⁶, B. Brau⁸⁴,
 J.E. Brau¹¹⁴, H.M. Braun¹⁷⁴, B. Breliev¹⁵⁸, J. Bremer²⁹, R. Brenner¹⁶⁶, S. Bressler¹⁵², D. Breton¹¹⁵,
 D. Britton⁵³, F.M. Brochu²⁷, I. Brock²⁰, R. Brock⁸⁸, T.J. Brodbeck⁷¹, E. Brodet¹⁵³, F. Broggi^{89a},
 C. Bromberg⁸⁸, G. Brooijmans³⁴, W.K. Brooks^{31b}, G. Brown⁸², H. Brown⁷,
 P.A. Bruckman de Renstrom³⁸, D. Bruncko^{144b}, R. Bruneliere⁴⁸, S. Brunet⁶¹, A. Bruni^{19a}, G. Bruni^{19a},
 M. Bruschi^{19a}, T. Buanes¹³, F. Bucci⁴⁹, J. Buchanan¹¹⁸, N.J. Buchanan², P. Buchholz¹⁴¹,
 R.M. Buckingham¹¹⁸, A.G. Buckley⁴⁵, S.I. Buda^{25a}, I.A. Budagov⁶⁵, B. Budick¹⁰⁸, V. Büscher⁸¹,
 L. Bugge¹¹⁷, D. Buira-Clark¹¹⁸, O. Bulekov⁹⁶, M. Bunse⁴², T. Buran¹¹⁷, H. Burckhart²⁹, S. Burdin⁷³,
 T. Burgess¹³, S. Burke¹²⁹, E. Busato³³, P. Bussey⁵³, C.P. Buszello¹⁶⁶, F. Butin²⁹, B. Butler¹⁴³,
 J.M. Butler²¹, C.M. Buttar⁵³, J.M. Butterworth⁷⁷, W. Buttinger²⁷, T. Byatt⁷⁷, S. Cabrera Urbán¹⁶⁷,
 D. Caforio^{19a,19b}, O. Cakir^{3a}, P. Calafiura¹⁴, G. Calderini⁷⁸, P. Calfayan⁹⁸, R. Calkins¹⁰⁶, L.P. Caloba^{23a},
 R. Caloi^{132a,132b}, D. Calvet³³, S. Calvet³³, R. Camacho Toro³³, P. Camarri^{133a,133b}, M. Cambiaghi^{119a,119b},
 D. Cameron¹¹⁷, S. Campana²⁹, M. Campanelli⁷⁷, V. Canale^{102a,102b}, F. Canelli^{30,h}, A. Canepa^{159a},
 J. Cantero⁸⁰, L. Capasso^{102a,102b}, M.D.M. Capeans Garrido²⁹, I. Caprini^{25a}, M. Caprini^{25a}, D. Capriotti⁹⁹,
 M. Capua^{36a,36b}, R. Caputo¹⁴⁸, R. Cardarelli^{133a}, T. Carli²⁹, G. Carlino^{102a}, L. Carminati^{89a,89b},
 B. Caron^{159a}, S. Caron⁴⁸, G.D. Carrillo Montoya¹⁷², A.A. Carter⁷⁵, J.R. Carter²⁷, J. Carvalho^{124a,i},
 D. Casadei¹⁰⁸, M.P. Casado¹¹, M. Cascella^{122a,122b}, C. Caso^{50a,50b,*}, A.M. Castaneda Hernandez¹⁷²,
 E. Castaneda-Miranda¹⁷², V. Castillo Gimenez¹⁶⁷, N.F. Castro^{124a}, G. Cataldi^{72a}, F. Cataneo²⁹,
 A. Catinaccio²⁹, J.R. Catmore⁷¹, A. Cattai²⁹, G. Cattani^{133a,133b}, S. Caughron⁸⁸, D. Cauz^{164a,164c},
 P. Cavalleri⁷⁸, D. Cavalli^{89a}, M. Cavalli-Sforza¹¹, V. Cavasinni^{122a,122b}, F. Ceradini^{134a,134b},
 A.S. Cerqueira^{23a}, A. Cerri²⁹, L. Cerrito⁷⁵, F. Cerutti⁴⁷, S.A. Cetin^{18b}, F. Cevenini^{102a,102b}, A. Chafaq^{135a},
 D. Chakraborty¹⁰⁶, K. Chan², B. Chapleau⁸⁵, J.D. Chapman²⁷, J.W. Chapman⁸⁷, E. Chareyre⁷⁸,
 D.G. Charlton¹⁷, V. Chavda⁸², C.A. Chavez Barajas²⁹, S. Cheatham⁸⁵, S. Chekanov⁵, S.V. Chekulaev^{159a},
 G.A. Chelkov⁶⁵, M.A. Chelstowska¹⁰⁴, C. Chen⁶⁴, H. Chen²⁴, S. Chen^{32c}, T. Chen^{32c}, X. Chen¹⁷²,
 S. Cheng^{32a}, A. Cheplakov⁶⁵, V.F. Chepurinov⁶⁵, R. Cherkaoui El Moursli^{135e}, V. Chernyatin²⁴, E. Cheu⁶,
 S.L. Cheung¹⁵⁸, L. Chevalier¹³⁶, G. Chiefari^{102a,102b}, L. Chikovani⁵¹, J.T. Childers^{58a}, A. Chilingarov⁷¹,
 G. Chiodini^{72a}, M.V. Chizhov⁶⁵, G. Choudalakis³⁰, S. Chouridou¹³⁷, I.A. Christidi⁷⁷, A. Christov⁴⁸,
 D. Chromek-Burckhart²⁹, M.L. Chu¹⁵¹, J. Chudoba¹²⁵, G. Ciapetti^{132a,132b}, K. Ciba³⁷, A.K. Ciftci^{3a},
 R. Ciftci^{3a}, D. Cinca³³, V. Cindro⁷⁴, M.D. Ciobotaru¹⁶³, C. Ciocca^{19a,19b}, A. Ciochio¹⁴, M. Cirilli⁸⁷,
 M. Ciubancan^{25a}, A. Clark⁴⁹, P.J. Clark⁴⁵, W. Cleland¹²³, J.C. Clemens⁸³, B. Clement⁵⁵,

C. Clement^{146a,146b}, R.W. Clift¹²⁹, Y. Coadou⁸³, M. Cobal^{164a,164c}, A. Coccaro^{50a,50b}, J. Cochran⁶⁴, P. Coe¹¹⁸, J.G. Cogan¹⁴³, J. Coggeshall¹⁶⁵, E. Cogneras¹⁷⁷, C.D. Cojocaru²⁸, J. Colas⁴, A.P. Colijn¹⁰⁵, C. Collard¹¹⁵, N.J. Collins¹⁷, C. Collins-Tooth⁵³, J. Collot⁵⁵, G. Colon⁸⁴, P. Conde Muiño^{124a}, E. Coniavitis¹¹⁸, M.C. Conidi¹¹, M. Consonni¹⁰⁴, V. Consorti⁴⁸, S. Constantinescu^{25a}, C. Conta^{119a,119b}, F. Conventi^{102a,j}, J. Cook²⁹, M. Cooke¹⁴, B.D. Cooper⁷⁷, A.M. Cooper-Sarkar¹¹⁸, N.J. Cooper-Smith⁷⁶, K. Copic³⁴, T. Cornelissen^{50a,50b}, M. Corradi^{19a}, F. Corriveau^{85,k}, A. Cortes-Gonzalez¹⁶⁵, G. Cortiana⁹⁹, G. Costa^{89a}, M.J. Costa¹⁶⁷, D. Costanzo¹³⁹, T. Costin³⁰, D. Côté²⁹, L. Courneyea¹⁶⁹, G. Cowan⁷⁶, C. Cowden²⁷, B.E. Cox⁸², K. Cranmer¹⁰⁸, F. Crescioli^{122a,122b}, M. Cristinziani²⁰, G. Crosetti^{36a,36b}, R. Crupi^{72a,72b}, S. Crépe-Renaudin⁵⁵, C.-M. Cuciuc^{25a}, C. Cuenca Almenar¹⁷⁵, T. Cuhadar Donszelmann¹³⁹, M. Curatolo⁴⁷, C.J. Curtis¹⁷, P. Cwetanski⁶¹, H. Czirr¹⁴¹, Z. Czyzula¹¹⁷, S. D'Auria⁵³, M. D'Onofrio⁷³, A. D'Orazio^{132a,132b}, P.V.M. Da Silva^{23a}, C. Da Via⁸², W. Dabrowski³⁷, T. Dai⁸⁷, C. Dallapiccola⁸⁴, M. Dam³⁵, M. Dameri^{50a,50b}, D.S. Damiani¹³⁷, H.O. Danielsson²⁹, D. Dannheim⁹⁹, V. Dao⁴⁹, G. Darbo^{50a}, G.L. Darlea^{25b}, C. Daum¹⁰⁵, J.P. Dauvergne²⁹, W. Davey⁸⁶, T. Davidek¹²⁶, N. Davidson⁸⁶, R. Davidson⁷¹, E. Davies^{118,c}, M. Davies⁹³, A.R. Davison⁷⁷, Y. Davygora^{58a}, E. Dawe¹⁴², I. Dawson¹³⁹, J.W. Dawson^{5,*}, R.K. Daya³⁹, K. De⁷, R. de Asmundis^{102a}, S. De Castro^{19a,19b}, P.E. De Castro Faria Salgado²⁴, S. De Cecco⁷⁸, J. de Graat⁹⁸, N. De Groot¹⁰⁴, P. de Jong¹⁰⁵, C. De La Taille¹¹⁵, H. De la Torre⁸⁰, B. De Lotto^{164a,164c}, L. De Mora⁷¹, L. De Nooij¹⁰⁵, D. De Pedis^{132a}, A. De Salvo^{132a}, U. De Sanctis^{164a,164c}, A. De Santo¹⁴⁹, J.B. De Vivie De Regie¹¹⁵, S. Dean⁷⁷, R. Debbe²⁴, D.V. Dedovich⁶⁵, J. Degenhardt¹²⁰, M. Dehchar¹¹⁸, C. Del Papa^{164a,164c}, J. Del Peso⁸⁰, T. Del Prete^{122a,122b}, M. Deliyergiyev⁷⁴, A. Dell'Acqua²⁹, L. Dell'Asta^{89a,89b}, M. Della Pietra^{102a,j}, D. della Volpe^{102a,102b}, M. Delmastro²⁹, P. Delpierre⁸³, N. Delruelle²⁹, P.A. Delsart⁵⁵, C. Deluca¹⁴⁸, S. Demers¹⁷⁵, M. Demichev⁶⁵, B. Demirkoz^{11,l}, J. Deng¹⁶³, S.P. Denisov¹²⁸, D. Derendarz³⁸, J.E. Derkaoui^{135d}, F. Derue⁷⁸, P. Dervan⁷³, K. Desch²⁰, E. Devetak¹⁴⁸, P.O. Deviveiros¹⁵⁸, A. Dewhurst¹²⁹, B. DeWilde¹⁴⁸, S. Dhaliwal¹⁵⁸, R. Dhullipudi^{24,m}, A. Di Ciaccio^{133a,133b}, L. Di Ciaccio⁴, A. Di Girolamo²⁹, B. Di Girolamo²⁹, S. Di Luise^{134a,134b}, A. Di Mattia⁸⁸, B. Di Micco²⁹, R. Di Nardo^{133a,133b}, A. Di Simone^{133a,133b}, R. Di Sipio^{19a,19b}, M.A. Diaz^{31a}, F. Diblen^{18c}, E.B. Diehl⁸⁷, J. Dietrich⁴¹, T.A. Dietzsch^{58a}, S. Diglio¹¹⁵, K. Dindar Yagci³⁹, J. Dingfelder²⁰, C. Dionisi^{132a,132b}, P. Dita^{25a}, S. Dita^{25a}, F. Dittus²⁹, F. Djama⁸³, T. Djobava⁵¹, M.A.B. do Vale^{23a}, A. Do Valle Wemans^{124a}, T.K.O. Doan⁴, M. Dobbs⁸⁵, R. Dobinson^{29,*}, D. Dobos²⁹, E. Dobson²⁹, M. Dobson¹⁶³, J. Dodd³⁴, C. Doglioni¹¹⁸, T. Doherty⁵³, Y. Doi^{66,*}, J. Dolejsi¹²⁶, I. Dolenc⁷⁴, Z. Dolezal¹²⁶, B.A. Dolgoshein^{96,*}, T. Dohmae¹⁵⁵, M. Donadelli^{23d}, M. Donega¹²⁰, J. Donini⁵⁵, J. Dopke²⁹, A. Doria^{102a}, A. Dos Anjos¹⁷², M. Dosil¹¹, A. Dotti^{122a,122b}, M.T. Dova⁷⁰, J.D. Dowell¹⁷, A.D. Doxiadis¹⁰⁵, A.T. Doyle⁵³, Z. Drasal¹²⁶, J. Drees¹⁷⁴, N. Dressnandt¹²⁰, H. Drevermann²⁹, C. Driouichi³⁵, M. Dris⁹, J. Dubbert⁹⁹, T. Dubbs¹³⁷, S. Dube¹⁴, E. Duchovni¹⁷¹, G. Duckeck⁹⁸, A. Dudarev²⁹, F. Dudziak⁶⁴, M. Dührssen²⁹, I.P. Duerdoth⁸², L. Duflot¹¹⁵, M.-A. Dufour⁸⁵, M. Dunford²⁹, H. Duran Yildiz^{3b}, R. Duxfield¹³⁹, M. Dwuznik³⁷, F. Dydak²⁹, M. Düren⁵², W.L. Ebenstein⁴⁴, J. Ebke⁹⁸, S. Eckert⁴⁸, S. Eckweiler⁸¹, K. Edmonds⁸¹, C.A. Edwards⁷⁶, N.C. Edwards⁵³, W. Ehrenfeld⁴¹, T. Ehrich⁹⁹, T. Eifert²⁹, G. Eigen¹³, K. Einsweiler¹⁴, E. Eisenhandler⁷⁵, T. Ekelof¹⁶⁶, M. El Kacimi^{135c}, M. Ellert¹⁶⁶, S. Elles⁴, F. Ellinghaus⁸¹, K. Ellis⁷⁵, N. Ellis²⁹, J. Elmsheuser⁹⁸, M. Elsing²⁹, D. Emelianov¹²⁹, R. Engelmann¹⁴⁸, A. Engl⁹⁸, B. Epp⁶², A. Eppig⁸⁷, J. Erdmann⁵⁴, A. Ereditato¹⁶, D. Eriksson^{146a}, J. Ernst¹, M. Ernst²⁴, J. Ernwein¹³⁶, D. Errede¹⁶⁵, S. Errede¹⁶⁵, E. Ertel⁸¹, M. Escalier¹¹⁵, C. Escobar¹⁶⁷, X. Espinal Curull¹¹, B. Esposito⁴⁷, F. Etienne⁸³, A.I. Etievre¹³⁶, E. Etzion¹⁵³, D. Evangelakou⁵⁴, H. Evans⁶¹, L. Fabbri^{19a,19b}, C. Fabre²⁹, R.M. Fakhruddinov¹²⁸, S. Falciano^{132a}, Y. Fang¹⁷², M. Fanti^{89a,89b}, A. Farbin⁷, A. Farilla^{134a}, J. Farley¹⁴⁸, T. Farooque¹⁵⁸, S.M. Farrington¹¹⁸, P. Farthouat²⁹, P. Fassnacht²⁹, D. Fassouliotis⁸, B. Fatholahzadeh¹⁵⁸, A. Favareto^{89a,89b}, L. Fayard¹¹⁵, S. Fazio^{36a,36b}, R. Febbraro³³, P. Federic^{144a}, O.L. Fedin¹²¹, W. Fedorko⁸⁸, M. Fehling-Kaschek⁴⁸, L. Feligioni⁸³, D. Fellmann⁵, C.U. Felzmann⁸⁶, C. Feng^{32d}, E.J. Feng³⁰, A.B. Fenyuk¹²⁸, J. Ferencei^{144b}, J. Ferland⁹³, W. Fernando¹⁰⁹, S. Ferrag⁵³, J. Ferrando⁵³, V. Ferrara⁴¹, A. Ferrari¹⁶⁶, P. Ferrari¹⁰⁵, R. Ferrari^{119a}, A. Ferrer¹⁶⁷, M.L. Ferrer⁴⁷, D. Ferrere⁴⁹, C. Ferretti⁸⁷, A. Ferretto Parodi^{50a,50b}, M. Fiascaris³⁰, F. Fiedler⁸¹, A. Filipčič⁷⁴, A. Filippas⁹, F. Filthaut¹⁰⁴, M. Fincke-Keeler¹⁶⁹, M.C.N. Fiolhais^{124a,i}, L. Fiorini¹⁶⁷, A. Firan³⁹, G. Fischer⁴¹, P. Fischer²⁰, M.J. Fisher¹⁰⁹, S.M. Fisher¹²⁹, M. Flechl⁴⁸, I. Fleck¹⁴¹, J. Fleckner⁸¹, P. Fleischmann¹⁷³, S. Fleischmann¹⁷⁴, T. Flick¹⁷⁴, L.R. Flores Castillo¹⁷², M.J. Flowerdew⁹⁹, M. Fokitis⁹, T. Fonseca Martin¹⁶,

D.A. Forbush¹³⁸, A. Formica¹³⁶, A. Forti⁸², D. Fortin^{159a}, J.M. Foster⁸², D. Fournier¹¹⁵, A. Foussat²⁹,
 A.J. Fowler⁴⁴, K. Fowler¹³⁷, H. Fox⁷¹, P. Francavilla^{122a,122b}, S. Franchino^{119a,119b}, D. Francis²⁹,
 T. Frank¹⁷¹, M. Franklin⁵⁷, S. Franz²⁹, M. Fraternali^{119a,119b}, S. Fratina¹²⁰, S.T. French²⁷, F. Friedrich⁴³,
 R. Froeschl²⁹, D. Froidevaux²⁹, J.A. Frost²⁷, C. Fukunaga¹⁵⁶, E. Fullana Torregrosa²⁹, J. Fuster¹⁶⁷,
 C. Gabaldon²⁹, O. Gabizon¹⁷¹, T. Gadfort²⁴, S. Gadomski⁴⁹, G. Gagliardi^{50a,50b}, P. Gagnon⁶¹, C. Galea⁹⁸,
 E.J. Gallas¹¹⁸, M.V. Gallas²⁹, V. Gallo¹⁶, B.J. Gallop¹²⁹, P. Gallus¹²⁵, E. Galyaev⁴⁰, K.K. Gan¹⁰⁹,
 Y.S. Gao^{143.f}, V.A. Gapienko¹²⁸, A. Gaponenko¹⁴, F. Garberon¹⁷⁵, M. Garcia-Sciveres¹⁴, C. García¹⁶⁷,
 J.E. García Navarro⁴⁹, R.W. Gardner³⁰, N. Garelli²⁹, H. Garitaonandia¹⁰⁵, V. Garonne²⁹, J. Garvey¹⁷,
 C. Gatti⁴⁷, G. Gaudio^{119a}, O. Gaumer⁴⁹, B. Gaur¹⁴¹, L. Gauthier¹³⁶, I.L. Gavrilenko⁹⁴, C. Gay¹⁶⁸,
 G. Gaycken²⁰, J.-C. Gayde²⁹, E.N. Gazis⁹, P. Ge^{32d}, C.N.P. Gee¹²⁹, D.A.A. Geerts¹⁰⁵, Ch. Geich-Gimbel²⁰,
 K. Gellerstedt^{146a,146b}, C. Gemme^{50a}, A. Gemmell⁵³, M.H. Genest⁹⁸, S. Gentile^{132a,132b}, M. George⁵⁴,
 S. George⁷⁶, P. Gerlach¹⁷⁴, A. Gershon¹⁵³, C. Geweniger^{58a}, H. Ghazlane^{135b}, P. Ghez⁴, N. Ghodbane³³,
 B. Giacobbe^{19a}, S. Giagu^{132a,132b}, V. Giakoumopoulou⁸, V. Giangiobbe^{122a,122b}, F. Gianotti²⁹,
 B. Gibbard²⁴, A. Gibson¹⁵⁸, S.M. Gibson²⁹, L.M. Gilbert¹¹⁸, M. Gilchriese¹⁴, V. Gilevsky⁹¹, D. Gillberg²⁸,
 A.R. Gillman¹²⁹, D.M. Gingrich^{2.e}, J. Ginzburg¹⁵³, N. Giokaris⁸, M.P. Giordani^{164c}, R. Giordano^{102a,102b},
 F.M. Giorgi¹⁵, P. Giovannini⁹⁹, P.F. Giraud¹³⁶, D. Giugni^{89a}, M. Giunta⁹³, P. Giusti^{19a}, B.K. Gjelsten¹¹⁷,
 L.K. Gladilin⁹⁷, C. Glasman⁸⁰, J. Glatzer⁴⁸, A. Glazov⁴¹, K.W. Glitza¹⁷⁴, G.L. Glonti⁶⁵, J. Godfrey¹⁴²,
 J. Godlewski²⁹, M. Goebel⁴¹, T. Göpfert⁴³, C. Goeringer⁸¹, C. Gössling⁴², T. Göttfert⁹⁹, S. Goldfarb⁸⁷,
 T. Golling¹⁷⁵, S.N. Golovnia¹²⁸, A. Gomes^{124a,b}, L.S. Gomez Fajardo⁴¹, R. Gonçalves⁷⁶,
 J. Goncalves Pinto Firmino Da Costa⁴¹, L. Gonella²⁰, A. Gonidec²⁹, S. Gonzalez¹⁷²,
 S. González de la Hoz¹⁶⁷, M.L. Gonzalez Silva²⁶, S. Gonzalez-Sevilla⁴⁹, J.J. Goodson¹⁴⁸, L. Goossens²⁹,
 P.A. Gorbounov⁹⁵, H.A. Gordon²⁴, I. Gorelov¹⁰³, G. Gorfine¹⁷⁴, B. Gorini²⁹, E. Gorini^{72a,72b}, A. Gorišek⁷⁴,
 E. Gornicki³⁸, S.A. Gorokhov¹²⁸, V.N. Goryachev¹²⁸, B. Gosdzik⁴¹, M. Gosselink¹⁰⁵, M.I. Gostkin⁶⁵,
 I. Gough Eschrich¹⁶³, M. Gouighri^{135a}, D. Goujdami^{135c}, M.P. Goulette⁴⁹, A.G. Goussiou¹³⁸, C. Goy⁴,
 I. Grabowska-Bold^{163.g}, V. Grabski¹⁷⁶, P. Grafström²⁹, C. Grah¹⁷⁴, K.-J. Grah⁴¹, F. Grancagnolo^{72a},
 S. Grancagnolo¹⁵, V. Grassi¹⁴⁸, V. Gratchev¹²¹, N. Grau³⁴, H.M. Gray²⁹, J.A. Gray¹⁴⁸, E. Graziani^{134a},
 O.G. Grebenyuk¹²¹, D. Greenfield¹²⁹, T. Greenshaw⁷³, Z.D. Greenwood^{24,m}, K. Gregersen³⁵,
 I.M. Gregor⁴¹, P. Grenier¹⁴³, J. Griffiths¹³⁸, N. Grigalashvili⁶⁵, A.A. Grillo¹³⁷, S. Grinstein¹¹,
 Y.V. Grishkevich⁹⁷, J.-F. Grivaz¹¹⁵, J. Grognuz²⁹, M. Groh⁹⁹, E. Gross¹⁷¹, J. Grosse-Knetter⁵⁴,
 J. Groth-Jensen¹⁷¹, K. Grybel¹⁴¹, V.J. Guarino⁵, D. Guest¹⁷⁵, C. Guicheney³³, A. Guida^{72a,72b},
 T. Guillemain⁴, S. Guindon⁵⁴, H. Guler^{85.n}, J. Gunther¹²⁵, B. Guo¹⁵⁸, J. Guo³⁴, A. Gupta³⁰, Y. Gusakov⁶⁵,
 V.N. Gushchin¹²⁸, A. Gutierrez⁹³, P. Gutierrez¹¹¹, N. Guttman¹⁵³, O. Gutzwiller¹⁷², C. Guyot¹³⁶,
 C. Gwenlan¹¹⁸, C.B. Gwilliam⁷³, A. Haas¹⁴³, S. Haas²⁹, C. Haber¹⁴, R. Hackenburg²⁴, H.K. Hadavand³⁹,
 D.R. Hadley¹⁷, P. Haefner⁹⁹, F. Hahn²⁹, S. Haider²⁹, Z. Hajduk³⁸, H. Hakobyan¹⁷⁶, J. Haller⁵⁴,
 K. Hamacher¹⁷⁴, P. Hamal¹¹³, A. Hamilton⁴⁹, S. Hamilton¹⁶¹, H. Han^{32a}, L. Han^{32b}, K. Hanagaki¹¹⁶,
 M. Hance¹²⁰, C. Handel⁸¹, P. Hanke^{58a}, J.R. Hansen³⁵, J.B. Hansen³⁵, J.D. Hansen³⁵, P.H. Hansen³⁵,
 P. Hansson¹⁴³, K. Hara¹⁶⁰, G.A. Hare¹³⁷, T. Harenberg¹⁷⁴, S. Harkusha⁹⁰, D. Harper⁸⁷,
 R.D. Harrington²¹, O.M. Harris¹³⁸, K. Harrison¹⁷, J. Hartert⁴⁸, F. Hartjes¹⁰⁵, T. Haruyama⁶⁶, A. Harvey⁵⁶,
 S. Hasegawa¹⁰¹, Y. Hasegawa¹⁴⁰, S. Hassani¹³⁶, M. Hatch²⁹, D. Hauff⁹⁹, S. Haug¹⁶, M. Hauschild²⁹,
 R. Hauser⁸⁸, M. Havranek²⁰, B.M. Hawes¹¹⁸, C.M. Hawkes¹⁷, R.J. Hawkings²⁹, D. Hawkins¹⁶³,
 T. Hayakawa⁶⁷, D. Hayden⁷⁶, H.S. Hayward⁷³, S.J. Haywood¹²⁹, E. Hazen²¹, M. He^{32d}, S.J. Head¹⁷,
 V. Hedberg⁷⁹, L. Heelan⁷, S. Heim⁸⁸, B. Heinemann¹⁴, S. Heisterkamp³⁵, L. Helary⁴, M. Heller¹¹⁵,
 S. Hellman^{146a,146b}, D. Hellmich²⁰, C. Hensens¹¹, R.C.W. Henderson⁷¹, M. Henke^{58a}, A. Henrichs⁵⁴,
 A.M. Henriques Correia²⁹, S. Henrot-Versille¹¹⁵, F. Henry-Couannier⁸³, C. Hensel⁵⁴, T. Henß¹⁷⁴,
 C.M. Hernandez⁷, Y. Hernández Jiménez¹⁶⁷, R. Herrberg¹⁵, A.D. Hershenhorn¹⁵², G. Herten⁴⁸,
 R. Hertenberger⁹⁸, L. Hervas²⁹, G.G. Hesketh⁷⁷, N.P. Hessey¹⁰⁵, A. Hidvegi^{146a}, E. Higón-Rodríguez¹⁶⁷,
 D. Hill^{5.*}, J.C. Hill²⁷, N. Hill⁵, K.H. Hiller⁴¹, S. Hillert²⁰, S.J. Hillier¹⁷, I. Hinchliffe¹⁴, E. Hines¹²⁰,
 M. Hirose¹¹⁶, F. Hirsch⁴², D. Hirschbuehl¹⁷⁴, J. Hobbs¹⁴⁸, N. Hod¹⁵³, M.C. Hodgkinson¹³⁹,
 P. Hodgson¹³⁹, A. Hoecker²⁹, M.R. Hoferkamp¹⁰³, J. Hoffman³⁹, D. Hoffmann⁸³, M. Hohlfeld⁸¹,
 M. Holder¹⁴¹, S.O. Holmgren^{146a}, T. Holy¹²⁷, J.L. Holzbauer⁸⁸, Y. Homma⁶⁷, T.M. Hong¹²⁰,
 L. Hooft van Huysduynen¹⁰⁸, T. Horazdovsky¹²⁷, C. Horn¹⁴³, S. Horner⁴⁸, K. Horton¹¹⁸, J.-Y. Hostachy⁵⁵,
 S. Hou¹⁵¹, M.A. Houlden⁷³, A. Hoummada^{135a}, J. Howarth⁸², D.F. Howell¹¹⁸, I. Hristova¹⁵, J. Hrivnac¹¹⁵,

I. Hruska¹²⁵, T. Hryn'ova⁴, P.J. Hsu¹⁷⁵, S.-C. Hsu¹⁴, G.S. Huang¹¹¹, Z. Hubacek¹²⁷, F. Hubaut⁸³, F. Huegging²⁰, T.B. Huffman¹¹⁸, E.W. Hughes³⁴, G. Hughes⁷¹, R.E. Hughes-Jones⁸², M. Huhtinen²⁹, P. Hurst⁵⁷, M. Hurwitz¹⁴, U. Husemann⁴¹, N. Huseynov^{65,o}, J. Huston⁸⁸, J. Huth⁵⁷, G. Iacobucci⁴⁹, G. Iakovidis⁹, M. Ibbotson⁸², I. Ibragimov¹⁴¹, R. Ichimiya⁶⁷, L. Iconomidou-Fayard¹¹⁵, J. Idarraga¹¹⁵, M. Idzik³⁷, P. Iengo^{102a,102b}, O. Igonkina¹⁰⁵, Y. Ikegami⁶⁶, M. Ikeno⁶⁶, Y. Ilchenko³⁹, D. Iliadis¹⁵⁴, D. Imbault⁷⁸, M. Imhaeuser¹⁷⁴, M. Imori¹⁵⁵, T. Ince²⁰, J. Inigo-Golfin²⁹, P. Ioannou⁸, M. Iodice^{134a}, G. Ionescu⁴, A. Irlles Quiles¹⁶⁷, K. Ishii⁶⁶, A. Ishikawa⁶⁷, M. Ishino⁶⁸, R. Ishmukhametov³⁹, C. Issever¹¹⁸, S. Istin^{18a}, A.V. Ivashin¹²⁸, W. Iwanski³⁸, H. Iwasaki⁶⁶, J.M. Izen⁴⁰, V. Izzo^{102a}, B. Jackson¹²⁰, J.N. Jackson⁷³, P. Jackson¹⁴³, M.R. Jaekel²⁹, V. Jain⁶¹, K. Jakobs⁴⁸, S. Jakobsen³⁵, J. Jakubek¹²⁷, D.K. Jana¹¹¹, E. Jankowski¹⁵⁸, E. Jansen⁷⁷, A. Jantsch⁹⁹, M. Janus²⁰, G. Jarlskog⁷⁹, L. Jeanty⁵⁷, K. Jelen³⁷, I. Jen-La Plante³⁰, P. Jenni²⁹, A. Jeremie⁴, P. Jež³⁵, S. Jézéquel⁴, M.K. Jha^{19a}, H. Ji¹⁷², W. Ji⁸¹, J. Jia¹⁴⁸, Y. Jiang^{32b}, M. Jimenez Belenguer⁴¹, G. Jin^{32b}, S. Jin^{32a}, O. Jinnouchi¹⁵⁷, M.D. Joergensen³⁵, D. Joffe³⁹, L.G. Johansen¹³, M. Johansen^{146a,146b}, K.E. Johansson^{146a}, P. Johansson¹³⁹, S. Johnert⁴¹, K.A. Johns⁶, K. Jon-And^{146a,146b}, G. Jones⁸², R.W.L. Jones⁷¹, T.W. Jones⁷⁷, T.J. Jones⁷³, O. Jonsson²⁹, C. Joram²⁹, P.M. Jorge^{124a,b}, J. Joseph¹⁴, T. Jovin^{12b}, X. Ju¹³⁰, V. Juranek¹²⁵, P. Jussel⁶², A. Juste Rozas¹¹, V.V. Kabachenko¹²⁸, S. Kabana¹⁶, M. Kaci¹⁶⁷, A. Kaczmarek³⁸, P. Kadlecik³⁵, M. Kado¹¹⁵, H. Kagan¹⁰⁹, M. Kagan⁵⁷, S. Kaiser⁹⁹, E. Kajomovitz¹⁵², S. Kalinin¹⁷⁴, L.V. Kalinovskaya⁶⁵, S. Kama³⁹, N. Kanaya¹⁵⁵, M. Kaneda²⁹, T. Kanno¹⁵⁷, V.A. Kantserov⁹⁶, J. Kanzaki⁶⁶, B. Kaplan¹⁷⁵, A. Kapliy³⁰, J. Kaplon²⁹, D. Kar⁴³, M. Karagoz¹¹⁸, M. Karnevskiy⁴¹, K. Karr⁵, V. Kartvelishvili⁷¹, A.N. Karyukhin¹²⁸, L. Kashif¹⁷², A. Kasmi³⁹, R.D. Kass¹⁰⁹, A. Kastanas¹³, M. Kataoka⁴, Y. Kataoka¹⁵⁵, E. Katsoufis⁹, J. Katzy⁴¹, V. Kaushik⁶, K. Kawagoe⁶⁷, T. Kawamoto¹⁵⁵, G. Kawamura⁸¹, M.S. Kayl¹⁰⁵, V.A. Kazanin¹⁰⁷, M.Y. Kazarinov⁶⁵, J.R. Keates⁸², R. Keeler¹⁶⁹, R. Kehoe³⁹, M. Keil⁵⁴, G.D. Kekelidze⁶⁵, M. Kelly⁸², J. Kennedy⁹⁸, C.J. Kenney¹⁴³, M. Kenyon⁵³, O. Kepka¹²⁵, N. Kerschen²⁹, B.P. Kerševan⁷⁴, S. Kersten¹⁷⁴, K. Kessoku¹⁵⁵, C. Ketterer⁴⁸, J. Keung¹⁵⁸, M. Khakzad²⁸, F. Khalil-zada¹⁰, H. Khandanyan¹⁶⁵, A. Khanov¹¹², D. Kharchenko⁶⁵, A. Khodinov⁹⁶, A.G. Kholodenko¹²⁸, A. Khomich^{58a}, T.J. Khoo²⁷, G. Khorauli²⁰, A. Khoroshilov¹⁷⁴, N. Khovanskiy⁶⁵, V. Khovanskiy⁹⁵, E. Khramov⁶⁵, J. Khubua⁵¹, H. Kim⁷, M.S. Kim², P.C. Kim¹⁴³, S.H. Kim¹⁶⁰, N. Kimura¹⁷⁰, O. Kind¹⁵, B.T. King⁷³, M. King⁶⁷, R.S.B. King¹¹⁸, J. Kirk¹²⁹, L.E. Kirsch²², A.E. Kiryunin⁹⁹, T. Kishimoto⁶⁷, D. Kisielewska³⁷, T. Kittelmann¹²³, A.M. Kiver¹²⁸, E. Kladiva^{144b}, J. Klaiber-Lodewigs⁴², M. Klein⁷³, U. Klein⁷³, K. Kleinknecht⁸¹, M. Klemetti⁸⁵, A. Klier¹⁷¹, A. Klimentov²⁴, R. Klingenberg⁴², E.B. Klinkby³⁵, T. Klioutchnikova²⁹, P.F. Klok¹⁰⁴, S. Klous¹⁰⁵, E.-E. Kluge^{58a}, T. Kluge⁷³, P. Kluit¹⁰⁵, S. Kluth⁹⁹, N.S. Knecht¹⁵⁸, E. Kneringer⁶², J. Knobloch²⁹, E.B.F.G. Knoops⁸³, A. Knue⁵⁴, B.R. Ko⁴⁴, T. Kobayashi¹⁵⁵, M. Kobel⁴³, M. Kocian¹⁴³, A. Kocnar¹¹³, P. Kodys¹²⁶, K. Köneke²⁹, A.C. König¹⁰⁴, S. Koenig⁸¹, L. Köpke⁸¹, F. Koetsveld¹⁰⁴, P. Koevesarki²⁰, T. Koffas²⁸, E. Koffeman¹⁰⁵, F. Kohn⁵⁴, Z. Kohout¹²⁷, T. Kohriki⁶⁶, T. Koi¹⁴³, T. Kokott²⁰, G.M. Kolachev¹⁰⁷, H. Kolanoski¹⁵, V. Kolesnikov⁶⁵, I. Koletsou^{89a}, J. Koll⁸⁸, D. Kollar²⁹, M. Kollefrath⁴⁸, S.D. Kolya⁸², A.A. Komar⁹⁴, Y. Komori¹⁵⁵, T. Kondo⁶⁶, T. Kono^{41,p}, A.I. Kononov⁴⁸, R. Konoplich^{108,q}, N. Konstantinidis⁷⁷, A. Kootz¹⁷⁴, S. Koperny³⁷, S.V. Kopikov¹²⁸, K. Korcyl³⁸, K. Kordas¹⁵⁴, V. Koreshev¹²⁸, A. Korn¹¹⁸, A. Korol¹⁰⁷, I. Korolkov¹¹, E.V. Korolkova¹³⁹, V.A. Korotkov¹²⁸, O. Kortner⁹⁹, S. Kortner⁹⁹, V.V. Kostyukhin²⁰, M.J. Kotamäki²⁹, S. Kotov⁹⁹, V.M. Kotov⁶⁵, A. Kotwal⁴⁴, C. Kourkoumelis⁸, V. Kouskoura¹⁵⁴, A. Koutsman¹⁰⁵, R. Kowalewski¹⁶⁹, T.Z. Kowalski³⁷, W. Kozanecki¹³⁶, A.S. Kozhin¹²⁸, V. Kral¹²⁷, V.A. Kramarenko⁹⁷, G. Kramberger⁷⁴, M.W. Krasny⁷⁸, A. Krasznahorkay¹⁰⁸, J. Kraus⁸⁸, A. Kreisel¹⁵³, F. Krejci¹²⁷, J. Kretzschmar⁷³, N. Krieger⁵⁴, P. Krieger¹⁵⁸, K. Kroeninger⁵⁴, H. Kroha⁹⁹, J. Kroll¹²⁰, J. Kroseberg²⁰, J. Krstic^{12a}, U. Kruchonak⁶⁵, H. Krüger²⁰, T. Kruker¹⁶, Z.V. Krumshteyn⁶⁵, A. Kruth²⁰, T. Kubota⁸⁶, S. Kuehn⁴⁸, A. Kugel^{58c}, T. Kuhl⁴¹, D. Kuhn⁶², V. Kukhtin⁶⁵, Y. Kulchitsky⁹⁰, S. Kuleshov^{31b}, C. Kummer⁹⁸, M. Kuna⁷⁸, N. Kundu¹¹⁸, J. Kunkle¹²⁰, A. Kupco¹²⁵, H. Kurashige⁶⁷, M. Kurata¹⁶⁰, Y.A. Kurochkin⁹⁰, V. Kus¹²⁵, W. Kuykendall¹³⁸, M. Kuze¹⁵⁷, P. Kuzhir⁹¹, J. Kvita²⁹, R. Kwee¹⁵, A. La Rosa¹⁷², L. La Rotonda^{36a,36b}, L. Labarga⁸⁰, J. Labbe⁴, S. Lablak^{135a}, C. Lacasta¹⁶⁷, F. Lacava^{132a,132b}, H. Lacker¹⁵, D. Lacour⁷⁸, V.R. Lacuesta¹⁶⁷, E. Ladygin⁶⁵, R. Lafaye⁴, B. Laforge⁷⁸, T. Lagouri⁸⁰, S. Lai⁴⁸, E. Laisne⁵⁵, M. Lamanna²⁹, C.L. Lampen⁶, W. Lampl⁶, E. Lancon¹³⁶, U. Landgraf⁴⁸, M.P.J. Landon⁷⁵, H. Landsman¹⁵², J.L. Lane⁸², C. Lange⁴¹, A.J. Lankford¹⁶³, F. Lanni²⁴, K. Lantzsck²⁹, S. Laplace⁷⁸, C. Lapoire²⁰, J.F. Laporte¹³⁶, T. Lari^{89a}, A.V. Larionov¹²⁸, A. Larner¹¹⁸, C. Lasseur²⁹, M. Lassnig²⁹, P. Laurelli⁴⁷,

A. Lavorato¹¹⁸, W. Lavrijsen¹⁴, P. Laycock⁷³, A.B. Lazarev⁶⁵, O. Le Dortz⁷⁸, E. Le Guirriec⁸³,
 C. Le Maner¹⁵⁸, E. Le Menedeu¹³⁶, C. Lebel⁹³, T. LeCompte⁵, F. Ledroit-Guillon⁵⁵, H. Lee¹⁰⁵,
 J.S.H. Lee¹⁵⁰, S.C. Lee¹⁵¹, L. Lee¹⁷⁵, M. Lefebvre¹⁶⁹, M. Legendre¹³⁶, A. Leger⁴⁹, B.C. LeGeyt¹²⁰,
 F. Legger⁹⁸, C. Leggett¹⁴, M. Lehmacher²⁰, G. Lehmann Miotto²⁹, X. Lei⁶, M.A.L. Leite^{23d}, R. Leitner¹²⁶,
 D. Lellouch¹⁷¹, M. Leltchouk³⁴, B. Lemmer⁵⁴, V. Lendermann^{58a}, K.J.C. Leney^{145b}, T. Lenz¹⁰⁵,
 G. Lenzen¹⁷⁴, B. Lenzi²⁹, K. Leonhardt⁴³, S. Leontsinis⁹, C. Leroy⁹³, J.-R. Lessard¹⁶⁹, J. Lesser^{146a},
 C.G. Lester²⁷, A. Leung Fook Cheong¹⁷², J. Levêque⁴, D. Levin⁸⁷, L.J. Levinson¹⁷¹, M.S. Levitski¹²⁸,
 M. Lewandowska²¹, A. Lewis¹¹⁸, G.H. Lewis¹⁰⁸, A.M. Leyko²⁰, M. Leyton¹⁵, B. Li⁸³, H. Li¹⁷², S. Li^{32b,d},
 X. Li⁸⁷, Z. Liang³⁹, Z. Liang^{118,r}, H. Liao³³, B. Liberti^{133a}, P. Lichard²⁹, M. Lichtnecker⁹⁸, K. Lie¹⁶⁵,
 W. Liebig¹³, R. Lifshitz¹⁵², J.N. Lilley¹⁷, C. Limbach²⁰, A. Limosani⁸⁶, M. Limper⁶³, S.C. Lin^{151,s},
 F. Linde¹⁰⁵, J.T. Linnemann⁸⁸, E. Lipeles¹²⁰, L. Lipinsky¹²⁵, A. Lipniacka¹³, T.M. Liss¹⁶⁵, D. Lissauer²⁴,
 A. Lister⁴⁹, A.M. Litke¹³⁷, C. Liu²⁸, D. Liu^{151,t}, H. Liu⁸⁷, J.B. Liu⁸⁷, M. Liu^{32b}, S. Liu², Y. Liu^{32b},
 M. Livan^{119a,119b}, S.S.A. Livermore¹¹⁸, A. Lleres⁵⁵, J. Llorente Merino⁸⁰, S.L. Lloyd⁷⁵, E. Lobodzinska⁴¹,
 P. Loch⁶, W.S. Lockman¹³⁷, T. Loddenkoetter²⁰, F.K. Loebinger⁸², A. Loginov¹⁷⁵, C.W. Loh¹⁶⁸, T. Lohse¹⁵,
 K. Lohwasser⁴⁸, M. Lokajicek¹²⁵, J. Loken¹¹⁸, V.P. Lombardo⁴, R.E. Long⁷¹, L. Lopes^{124a,b},
 D. Lopez Mateos⁵⁷, M. Losada¹⁶², P. Loscutoff¹⁴, F. Lo Sterzo^{132a,132b}, M.J. Losty^{159a}, X. Lou⁴⁰,
 A. Lounis¹¹⁵, K.F. Loureiro¹⁶², J. Love²¹, P.A. Love⁷¹, A.J. Lowe^{143,f}, F. Lu^{32a}, H.J. Lubatti¹³⁸,
 C. Luci^{132a,132b}, A. Lucotte⁵⁵, A. Ludwig⁴³, D. Ludwig⁴¹, I. Ludwig⁴⁸, J. Ludwig⁴⁸, F. Luehring⁶¹,
 G. Luijckx¹⁰⁵, D. Lumb⁴⁸, L. Luminari^{132a}, E. Lund¹¹⁷, B. Lund-Jensen¹⁴⁷, B. Lundberg⁷⁹,
 J. Lundberg^{146a,146b}, J. Lundquist³⁵, M. Lungwitz⁸¹, A. Lupi^{122a,122b}, G. Lutz⁹⁹, D. Lynn²⁴, J. Lys¹⁴,
 E. Lytken⁷⁹, H. Ma²⁴, L.L. Ma¹⁷², J.A. Macana Goia⁹³, G. Maccarrone⁴⁷, A. Macchiolo⁹⁹, B. Maček⁷⁴,
 J. Machado Miguens^{124a}, R. Mackeprang³⁵, R.J. Madaras¹⁴, W.F. Mader⁴³, R. Maenner^{58c}, T. Maeno²⁴,
 P. Mättig¹⁷⁴, S. Mättig⁴¹, L. Magnoni²⁹, E. Magradze⁵⁴, Y. Mahalalel¹⁵³, K. Mahboubi⁴⁸, G. Mahout¹⁷,
 C. Maiani^{132a,132b}, C. Maidantchik^{23a}, A. Maio^{124a,b}, S. Majewski²⁴, Y. Makida⁶⁶, N. Makovec¹¹⁵,
 P. Mal⁶, Pa. Malecki³⁸, P. Malecki³⁸, V.P. Maleev¹²¹, F. Malek⁵⁵, U. Mallik⁶³, D. Malon⁵, C. Malone¹⁴³,
 S. Maltezos⁹, V. Malyshev¹⁰⁷, S. Malyukov²⁹, R. Mameghani⁹⁸, J. Mamuzic^{12b}, A. Manabe⁶⁶,
 L. Mandelli^{89a}, I. Mandić⁷⁴, R. Mandrysch¹⁵, J. Maneira^{124a}, P.S. Mangeard⁸⁸, I.D. Manjavidze⁶⁵,
 A. Mann⁵⁴, P.M. Manning¹³⁷, A. Manousakis-Katsikakis⁸, B. Mansoulie¹³⁶, A. Manz⁹⁹, A. Mapelli²⁹,
 L. Mapelli²⁹, L. March⁸⁰, J.F. Marchand²⁹, F. Marchese^{133a,133b}, G. Marchiori⁷⁸, M. Marcisovsky¹²⁵,
 A. Marin^{21,*}, C.P. Marino⁶¹, F. Marroquim^{23a}, R. Marshall⁸², Z. Marshall²⁹, F.K. Martens¹⁵⁸,
 S. Marti-Garcia¹⁶⁷, A.J. Martin¹⁷⁵, B. Martin²⁹, B. Martin⁸⁸, F.F. Martin¹²⁰, J.P. Martin⁹³, Ph. Martin⁵⁵,
 T.A. Martin¹⁷, V.J. Martin⁴⁵, B. Martin dit Latour⁴⁹, S. Martin-Haugh¹⁴⁹, M. Martinez¹¹,
 V. Martinez Outschoorn⁵⁷, A.C. Martyniuk⁸², M. Marx⁸², F. Marzano^{132a}, A. Marzin¹¹¹, L. Masetti⁸¹,
 T. Mashimo¹⁵⁵, R. Mashinistov⁹⁴, J. Masik⁸², A.L. Maslennikov¹⁰⁷, I. Massa^{19a,19b}, G. Massaro¹⁰⁵,
 N. Massol⁴, P. Mastrandrea^{132a,132b}, A. Mastroberardino^{36a,36b}, T. Masubuchi¹⁵⁵, M. Mathes²⁰,
 P. Matricon¹¹⁵, H. Matsumoto¹⁵⁵, H. Matsunaga¹⁵⁵, T. Matsushita⁶⁷, C. Mattravers^{118,c}, J.M. Maugein²⁹,
 S.J. Maxfield⁷³, D.A. Maximov¹⁰⁷, E.N. May⁵, A. Mayne¹³⁹, R. Mazini¹⁵¹, M. Mazur²⁰, M. Mazzanti^{89a},
 E. Mazzoni^{122a,122b}, S.P. Mc Kee⁸⁷, A. McCarn¹⁶⁵, R.L. McCarthy¹⁴⁸, T.G. McCarthy²⁸, N.A. McCubbin¹²⁹,
 K.W. McFarlane⁵⁶, J.A. McFayden¹³⁹, H. McGlone⁵³, G. Mchedlidze⁵¹, R.A. McLaren²⁹, T. Mclaughlan¹⁷,
 S.J. McMahan¹²⁹, R.A. McPherson^{169,k}, A. Meade⁸⁴, J. Mechnich¹⁰⁵, M. Mechtel¹⁷⁴, M. Medinnis⁴¹,
 R. Meera-Lebbai¹¹¹, T. Meguro¹¹⁶, R. Mehdiyev⁹³, S. Mehlhase³⁵, A. Mehta⁷³, K. Meier^{58a},
 J. Meinhardt⁴⁸, B. Meirose⁷⁹, C. Melachrinou³⁰, B.R. Mellado Garcia¹⁷², L. Mendoza Navas¹⁶²,
 Z. Meng^{151,t}, A. Mengarelli^{19a,19b}, S. Menke⁹⁹, C. Menot²⁹, E. Meoni¹¹, K.M. Mercurio⁵⁷, P. Mermod¹¹⁸,
 L. Merola^{102a,102b}, C. Meroni^{89a}, F.S. Merritt³⁰, A. Messina²⁹, J. Metcalfe¹⁰³, A.S. Mete⁶⁴, S. Meuser²⁰,
 C. Meyer⁸¹, J.-P. Meyer¹³⁶, J. Meyer¹⁷³, J. Meyer⁵⁴, T.C. Meyer²⁹, W.T. Meyer⁶⁴, J. Miao^{32d}, S. Michal²⁹,
 L. Micu^{25a}, R.P. Middleton¹²⁹, P. Miele²⁹, S. Migas⁷³, L. Mijović⁴¹, G. Mikenberg¹⁷¹, M. Mikestikova¹²⁵,
 M. Mikuz⁷⁴, D.W. Miller¹⁴³, R.J. Miller⁸⁸, W.J. Mills¹⁶⁸, C. Mills⁵⁷, A. Milov¹⁷¹, D.A. Milstead^{146a,146b},
 D. Milstein¹⁷¹, A.A. Minaenko¹²⁸, M. Miñano¹⁶⁷, I.A. Minashvili⁶⁵, A.I. Mincer¹⁰⁸, B. Mindur³⁷,
 M. Mineev⁶⁵, Y. Ming¹³⁰, L.M. Mir¹¹, G. Mirabelli^{132a}, L. Miralles Verge¹¹, A. Misiejuk⁷⁶, J. Mitrevski¹³⁷,
 G.Y. Mitrofanov¹²⁸, V.A. Mitsou¹⁶⁷, S. Mitsui⁶⁶, P.S. Miyagawa¹³⁹, K. Miyazaki⁶⁷, J.U. Mjörnmark⁷⁹,
 T. Moa^{146a,146b}, P. Mockett¹³⁸, S. Moed⁵⁷, V. Moeller²⁷, K. Mönig⁴¹, N. Möser²⁰, S. Mohapatra¹⁴⁸,
 W. Mohr⁴⁸, S. Mohr dieck-Möck⁹⁹, A.M. Moiseev^{128,*}, R. Moles-Valls¹⁶⁷, J. Molina-Perez²⁹, J. Monk⁷⁷,

E. Monnier⁸³, S. Montesano^{89a,89b}, F. Monticelli⁷⁰, S. Monzani^{19a,19b}, R.W. Moore², G.F. Moorhead⁸⁶, C. Mora Herrera⁴⁹, A. Moraes⁵³, N. Morange¹³⁶, J. Morel⁵⁴, G. Morello^{36a,36b}, D. Moreno⁸¹, M. Moreno Llácer¹⁶⁷, P. Morettini^{50a}, M. Morii⁵⁷, J. Morin⁷⁵, Y. Morita⁶⁶, A.K. Morley²⁹, G. Mornacchi²⁹, S.V. Morozov⁹⁶, J.D. Morris⁷⁵, L. Morvaj¹⁰¹, H.G. Moser⁹⁹, M. Mosidze⁵¹, J. Moss¹⁰⁹, R. Mount¹⁴³, E. Mountricha¹³⁶, S.V. Mouraviev⁹⁴, E.J.W. Moyse⁸⁴, M. Mudrinic^{12b}, F. Mueller^{58a}, J. Mueller¹²³, K. Mueller²⁰, T.A. Müller⁹⁸, D. Muenstermann²⁹, A. Muir¹⁶⁸, Y. Munwes¹⁵³, W.J. Murray¹²⁹, I. Mussche¹⁰⁵, E. Musto^{102a,102b}, A.G. Myagkov¹²⁸, M. Myska¹²⁵, J. Nadal¹¹, K. Nagai¹⁶⁰, K. Nagano⁶⁶, Y. Nagasaka⁶⁰, A.M. Nairz²⁹, Y. Nakahama²⁹, K. Nakamura¹⁵⁵, I. Nakano¹¹⁰, G. Nanava²⁰, A. Napier¹⁶¹, M. Nash^{77,c}, N.R. Nation²¹, T. Nattermann²⁰, T. Naumann⁴¹, G. Navarro¹⁶², H.A. Neal⁸⁷, E. Nebot⁸⁰, P.Yu. Nechaeva⁹⁴, A. Negri^{119a,119b}, G. Negri²⁹, S. Nektarijevic⁴⁹, A. Nelson⁶⁴, S. Nelson¹⁴³, T.K. Nelson¹⁴³, S. Nemecek¹²⁵, P. Nemethy¹⁰⁸, A.A. Nepomuceno^{23a}, M. Nessi^{29,u}, S.Y. Nesterov¹²¹, M.S. Neubauer¹⁶⁵, A. Neusiedl⁸¹, R.M. Neves¹⁰⁸, P. Nevski²⁴, P.R. Newman¹⁷, V. Nguyen Thi Hong¹³⁶, R.B. Nickerson¹¹⁸, R. Nicolaidou¹³⁶, L. Nicolas¹³⁹, B. Nicquevert²⁹, F. Niedercorn¹¹⁵, J. Nielsen¹³⁷, T. Niinikoski²⁹, N. Nikiforou³⁴, A. Nikiforov¹⁵, V. Nikolaenko¹²⁸, K. Nikolaev⁶⁵, I. Nikolic-Audit⁷⁸, K. Nikolics⁴⁹, K. Nikolopoulos²⁴, H. Nilsen⁴⁸, P. Nilsson⁷, Y. Ninomiya¹⁵⁵, A. Nisati^{132a}, T. Nishiyama⁶⁷, R. Nisius⁹⁹, L. Nodulman⁵, M. Nomachi¹¹⁶, I. Nomidis¹⁵⁴, M. Nordberg²⁹, B. Nordkvist^{146a,146b}, P.R. Norton¹²⁹, J. Novakova¹²⁶, M. Nozaki⁶⁶, M. Nožička⁴¹, L. Nozka¹¹³, I.M. Nugent^{159a}, A.-E. Nuncio-Quiroz²⁰, G. Nunes Hanninger⁸⁶, T. Nunnemann⁹⁸, E. Nurse⁷⁷, T. Nyman²⁹, B.J. O'Brien⁴⁵, S.W. O'Neale^{17,*}, D.C. O'Neil¹⁴², V. O'Shea⁵³, F.G. Oakham^{28,e}, H. Oberlack⁹⁹, J. Ocariz⁷⁸, A. Ochi⁶⁷, S. Oda¹⁵⁵, S. Odaka⁶⁶, J. Odier⁸³, H. Ogren⁶¹, A. Oh⁸², S.H. Oh⁴⁴, C.C. Ohm^{146a,146b}, T. Ohshima¹⁰¹, H. Ohshita¹⁴⁰, T.K. Ohska⁶⁶, T. Ohsugi⁵⁹, S. Okada⁶⁷, H. Okawa¹⁶³, Y. Okumura¹⁰¹, T. Okuyama¹⁵⁵, M. Olcese^{50a}, A.G. Olchevski⁶⁵, M. Oliveira^{124a,i}, D. Oliveira Damazio²⁴, E. Oliver Garcia¹⁶⁷, D. Olivito¹²⁰, A. Olszewski³⁸, J. Olszowska³⁸, C. Omachi⁶⁷, A. Onofre^{124a,v}, P.U.E. Onyisi³⁰, C.J. Oram^{159a}, M.J. Oreglia³⁰, Y. Oren¹⁵³, D. Orestano^{134a,134b}, I. Orlov¹⁰⁷, C. Oropeza Barrera⁵³, R.S. Orr¹⁵⁸, B. Osculati^{50a,50b}, R. Ospanov¹²⁰, C. Osuna¹¹, G. Otero y Garzon²⁶, J.P. Ottersbach¹⁰⁵, M. Ouchrif^{135d}, F. Ould-Saada¹¹⁷, A. Ouraou¹³⁶, Q. Ouyang^{32a}, M. Owen⁸², S. Owen¹³⁹, V.E. Ozcan^{18a}, N. Ozturk⁷, A. Pacheco Pages¹¹, C. Padilla Aranda¹¹, S. Pagan Griso¹⁴, E. Paganis¹³⁹, F. Paige²⁴, K. Pajchel¹¹⁷, G. Palacino^{159b}, C.P. Paelari⁶, S. Palestini²⁹, D. Pallin³³, A. Palma^{124a,b}, J.D. Palmer¹⁷, Y.B. Pan¹⁷², E. Panagiotopoulou⁹, B. Panes^{31a}, N. Panikashvili⁸⁷, S. Panitkin²⁴, D. Pantea^{25a}, M. Panuskova¹²⁵, V. Paolone¹²³, A. Papadelis^{146a}, Th.D. Papadopoulou⁹, A. Paramonov⁵, W. Park^{24,w}, M.A. Parker²⁷, F. Parodi^{50a,50b}, J.A. Parsons³⁴, U. Parzefall⁴⁸, E. Pasqualucci^{132a}, A. Passeri^{134a}, F. Pastore^{134a,134b}, Fr. Pastore⁷⁶, G. Pásztor^{49,x}, S. Patariaia¹⁷², N. Patel¹⁵⁰, J.R. Pater⁸², S. Patricelli^{102a,102b}, T. Pauly²⁹, M. Pecsny^{144a}, M.I. Pedraza Morales¹⁷², S.V. Peleganchuk¹⁰⁷, H. Peng^{32b}, R. Pengo²⁹, A. Penson³⁴, J. Penwell⁶¹, M. Perantoni^{23a}, K. Perez^{34,y}, T. Perez Cavalcanti⁴¹, E. Perez Codina¹¹, M.T. Pérez García-Estañ¹⁶⁷, V. Perez Reale³⁴, L. Perini^{89a,89b}, H. Pernegger²⁹, R. Perrino^{72a}, P. Perrodo⁴, S. Persema^{3a}, V.D. Peshekhonov⁶⁵, B.A. Petersen²⁹, J. Petersen²⁹, T.C. Petersen³⁵, E. Petit⁸³, A. Petridis¹⁵⁴, C. Petridou¹⁵⁴, E. Petrolo^{132a}, F. Petrucci^{134a,134b}, D. Petschull⁴¹, M. Petteni¹⁴², R. Pezoa^{31b}, A. Phan⁸⁶, A.W. Phillips²⁷, P.W. Phillips¹²⁹, G. Piacquadio²⁹, E. Piccaro⁷⁵, M. Piccinini^{19a,19b}, A. Pickford⁵³, S.M. Piec⁴¹, R. Piegai²⁶, J.E. Pilcher³⁰, A.D. Pilkington⁸², J. Pina^{124a,b}, M. Pinamonti^{164a,164c}, A. Pinder¹¹⁸, J.L. Pinfold², J. Ping^{32c}, B. Pinto^{124a,b}, O. Pirotte²⁹, C. Pizio^{89a,89b}, R. Placakyte⁴¹, M. Plamondon¹⁶⁹, W.G. Plano⁸², M.-A. Pleier²⁴, A.V. Pleskach¹²⁸, A. Poblaguev²⁴, S. Poddar^{58a}, F. Podlyski³³, L. Poggioli¹¹⁵, T. Poghosyan²⁰, M. Pohl⁴⁹, F. Polci⁵⁵, G. Polesello^{119a}, A. Policicchio¹³⁸, A. Polini^{19a}, J. Poll⁷⁵, V. Polychronakos²⁴, D.M. Pomarede¹³⁶, D. Pomeroy²², K. Pommès²⁹, L. Pontecorvo^{132a}, B.G. Pope⁸⁸, G.A. Popeneciu^{25a}, D.S. Popovic^{12a}, A. Poppleton²⁹, X. Portell Bueso²⁹, R. Porter¹⁶³, C. Posch²¹, G.E. Pospelov⁹⁹, S. Pospisil¹²⁷, I.N. Potrap⁹⁹, C.J. Potter¹⁴⁹, C.T. Potter¹¹⁴, G. Poulard²⁹, J. Poveda¹⁷², R. Prabhu⁷⁷, P. Pralavorio⁸³, S. Prasad⁵⁷, R. Pravahan⁷, S. Prell⁶⁴, K. Pretzl¹⁶, L. Pribyl²⁹, D. Price⁶¹, L.E. Price⁵, M.J. Price²⁹, P.M. Prichard⁷³, D. Prieur¹²³, M. Primavera^{72a}, K. Prokofiev¹⁰⁸, F. Prokoshin^{31b}, S. Protopopescu²⁴, J. Proudfoot⁵, X. Prudent⁴³, H. Przysiezniak⁴, S. Psoroulas²⁰, E. Ptacek¹¹⁴, E. Pueschel⁸⁴, J. Purdham⁸⁷, M. Purohit^{24,w}, P. Puzo¹¹⁵, Y. Pylypchenko¹¹⁷, J. Qian⁸⁷, Z. Qian⁸³, Z. Qin⁴¹, A. Quadt⁵⁴, D.R. Quarrie¹⁴, W.B. Quayle¹⁷², F. Quinonez^{31a}, M. Raas¹⁰⁴, V. Radescu^{58b}, B. Radics²⁰, T. Rador^{18a}, F. Ragusa^{89a,89b}, G. Rahal¹⁷⁷, A.M. Rahimi¹⁰⁹, D. Rahm²⁴, S. Rajagopalan²⁴, M. Rammensee⁴⁸, M. Rammes¹⁴¹,

M. Ramstedt^{146a,146b}, A.S. Randle-Conde³⁹, K. Randrianarivony²⁸, P.N. Ratoff⁷¹, F. Rauscher⁹⁸,
 E. Rauter⁹⁹, M. Raymond²⁹, A.L. Read¹¹⁷, D.M. Rebuffi^{119a,119b}, A. Redelbach¹⁷³, G. Redlinger²⁴,
 R. Reece¹²⁰, K. Reeves⁴⁰, A. Reichold¹⁰⁵, E. Reinherz-Aronis¹⁵³, A. Reinsch¹¹⁴, I. Reisinger⁴²,
 D. Reljic^{12a}, C. Rembser²⁹, Z.L. Ren¹⁵¹, A. Renaud¹¹⁵, P. Renkel³⁹, M. Rescigno^{132a}, S. Resconi^{89a},
 B. Resende¹³⁶, P. Reznicek⁹⁸, R. Rezvani¹⁵⁸, A. Richards⁷⁷, R. Richter⁹⁹, E. Richter-Was^{4,z}, M. Ridel⁷⁸,
 S. Rieke⁸¹, M. Rijpstra¹⁰⁵, M. Rijssenbeek¹⁴⁸, A. Rimoldi^{119a,119b}, L. Rinaldi^{19a}, R.R. Rios³⁹, I. Riu¹¹,
 G. Rivoltella^{89a,89b}, F. Rizatdinova¹¹², E. Rizvi⁷⁵, S.H. Robertson^{85,k}, A. Robichaud-Veronneau⁴⁹,
 D. Robinson²⁷, J.E.M. Robinson⁷⁷, M. Robinson¹¹⁴, A. Robson⁵³, J.G. Rocha de Lima¹⁰⁶, C. Roda^{122a,122b},
 D. Roda Dos Santos²⁹, S. Rodier⁸⁰, D. Rodriguez¹⁶², A. Roe⁵⁴, S. Roe²⁹, O. Røhne¹¹⁷, V. Rojo¹,
 S. Rolli¹⁶¹, A. Romaniouk⁹⁶, V.M. Romanov⁶⁵, G. Romeo²⁶, L. Roos⁷⁸, E. Ros¹⁶⁷, S. Rosati^{132a,132b},
 K. Rosbach⁴⁹, A. Rose¹⁴⁹, M. Rose⁷⁶, G.A. Rosenbaum¹⁵⁸, E.I. Rosenberg⁶⁴, P.L. Rosendahl¹³,
 O. Rosenthal¹⁴¹, L. Rosselet⁴⁹, V. Rossetti¹¹, E. Rossi^{132a,132b}, L.P. Rossi^{50a}, L. Rossi^{89a,89b}, M. Rotaru^{25a},
 I. Roth¹⁷¹, J. Rothberg¹³⁸, D. Rousseau¹¹⁵, C.R. Royon¹³⁶, A. Rozanov⁸³, Y. Rozen¹⁵², X. Ruan¹¹⁵,
 I. Rubinskiy⁴¹, B. Ruckert⁹⁸, N. Ruckstuhl¹⁰⁵, V.I. Rud⁹⁷, C. Rudolph⁴³, G. Rudolph⁶², F. Rühr⁶,
 F. Ruggieri^{134a,134b}, A. Ruiz-Martinez⁶⁴, E. Rulikowska-Zarebska³⁷, V. Rumiantsev^{91,*}, L. Rumyantsev⁶⁵,
 K. Runge⁴⁸, O. Runolfsson²⁰, Z. Rurikova⁴⁸, N.A. Rusakovich⁶⁵, D.R. Rust⁶¹, J.P. Rutherford⁶,
 C. Ruwiedel¹⁴, P. Ruzicka¹²⁵, Y.F. Ryabov¹²¹, V. Ryadovikov¹²⁸, P. Ryan⁸⁸, M. Rybar¹²⁶, G. Rybkin¹¹⁵,
 N.C. Ryder¹¹⁸, S. Rzaeva¹⁰, A.F. Saavedra¹⁵⁰, I. Sadeh¹⁵³, H.F.-W. Sadrozinski¹³⁷, R. Sadykov⁶⁵,
 F. Safai Tehrani^{132a,132b}, H. Sakamoto¹⁵⁵, G. Salamanna⁷⁵, A. Salamon^{133a}, M. Saleem¹¹¹, D. Salihagic⁹⁹,
 A. Salnikov¹⁴³, J. Salt¹⁶⁷, B.M. Salvachua Ferrando⁵, D. Salvatore^{36a,36b}, F. Salvatore¹⁴⁹, A. Salvucci¹⁰⁴,
 A. Salzburger²⁹, D. Sampsonidis¹⁵⁴, B.H. Samset¹¹⁷, A. Sanchez^{102a,102b}, H. Sandaker¹³, H.G. Sander⁸¹,
 M.P. Sanders⁹⁸, M. Sandhoff¹⁷⁴, T. Sandoval²⁷, C. Sandoval¹⁶², R. Sandstroem⁹⁹, S. Sandvoss¹⁷⁴,
 D.P.C. Sankey¹²⁹, A. Sansoni⁴⁷, C. Santamarina Rios⁸⁵, C. Santoni³³, R. Santonico^{133a,133b}, H. Santos^{124a},
 J.G. Saraiva^{124a,b}, T. Sarangi¹⁷², E. Sarkisyan-Grinbaum⁷, F. Sarri^{122a,122b}, G. Sartisohn¹⁷⁴, O. Sasaki⁶⁶,
 T. Sasaki⁶⁶, N. Sasao⁶⁸, I. Satsounkevitch⁹⁰, G. Sauvage⁴, E. Sauvan⁴, J.B. Sauvan¹¹⁵, P. Savard^{158,e},
 V. Savinov¹²³, D.O. Savu²⁹, P. Savva⁹, L. Sawyer^{24,m}, D.H. Saxon⁵³, L.P. Says³³, C. Sbarra^{19a,19b},
 A. Sbrizzi^{19a,19b}, O. Scallon⁹³, D.A. Scannicchio¹⁶³, J. Schaarschmidt¹¹⁵, P. Schacht⁹⁹, U. Schäfer⁸¹,
 S. Schaepe²⁰, S. Schaezel^{58b}, A.C. Schaffer¹¹⁵, D. Schaile⁹⁸, R.D. Schamberger¹⁴⁸, A.G. Schamov¹⁰⁷,
 V. Scharf^{58a}, V.A. Schegelsky¹²¹, D. Scheirich⁸⁷, M. Schernau¹⁶³, M.I. Scherzer¹⁴, C. Schiavi^{50a,50b},
 J. Schieck⁹⁸, M. Schioppa^{36a,36b}, S. Schlenker²⁹, J.L. Schlereth⁵, E. Schmidt⁴⁸, K. Schmieden²⁰,
 C. Schmitt⁸¹, S. Schmitt^{58b}, M. Schmitz²⁰, A. Schöning^{58b}, M. Schott²⁹, D. Schouten¹⁴²,
 J. Schovancova¹²⁵, M. Schram⁸⁵, C. Schroeder⁸¹, N. Schroer^{58c}, S. Schuh²⁹, G. Schuler²⁹, J. Schultes¹⁷⁴,
 H.-C. Schultz-Coulon^{58a}, H. Schulz¹⁵, J.W. Schumacher²⁰, M. Schumacher⁴⁸, B.A. Schumm¹³⁷,
 Ph. Schune¹³⁶, C. Schwanenberger⁸², A. Schwartzman¹⁴³, Ph. Schwemling⁷⁸, R. Schwienhorst⁸⁸,
 R. Schwierz⁴³, J. Schwindling¹³⁶, T. Schwindt²⁰, W.G. Scott¹²⁹, J. Searcy¹¹⁴, E. Sedykh¹²¹, E. Segura¹¹,
 S.C. Seidel¹⁰³, A. Seiden¹³⁷, F. Seifert⁴³, J.M. Seixas^{23a}, G. Sekhniaidze^{102a}, D.M. Seliverstov¹²¹,
 B. Sellden^{146a}, G. Sellers⁷³, M. Seman^{144b}, N. Semprini-Cesari^{19a,19b}, C. Serfon⁹⁸, L. Serin¹¹⁵,
 R. Seuster⁹⁹, H. Severini¹¹¹, M.E. Sevior⁸⁶, A. Sfyrta²⁹, E. Shabalina⁵⁴, M. Shamim¹¹⁴, L.Y. Shan^{32a},
 J.T. Shank²¹, Q.T. Shao⁸⁶, M. Shapiro¹⁴, P.B. Shatalov⁹⁵, L. Shaver⁶, K. Shaw^{164a,164c}, D. Sherman¹⁷⁵,
 P. Sherwood⁷⁷, A. Shibata¹⁰⁸, H. Shichi¹⁰¹, S. Shimizu²⁹, M. Shimojima¹⁰⁰, T. Shin⁵⁶, A. Shmeleva⁹⁴,
 M.J. Shochet³⁰, D. Short¹¹⁸, M.A. Shupe⁶, P. Sicho¹²⁵, A. Sidoti^{132a,132b}, A. Siebel¹⁷⁴, F. Siegert⁴⁸,
 J. Siegrist¹⁴, Dj. Sijacki^{12a}, O. Silbert¹⁷¹, J. Silva^{124a,b}, Y. Silver¹⁵³, D. Silverstein¹⁴³, S.B. Silverstein^{146a},
 V. Simak¹²⁷, O. Simard¹³⁶, Lj. Simic^{12a}, S. Simion¹¹⁵, B. Simmons⁷⁷, M. Simonyan³⁵, P. Sinervo¹⁵⁸,
 N.B. Sinev¹¹⁴, V. Sipica¹⁴¹, G. Siragusa¹⁷³, A. Sircar²⁴, A.N. Sisakyan⁶⁵, S.Yu. Sivoklov⁹⁷,
 J. Sjölin^{146a,146b}, T.B. Sjurson¹³, L.A. Skinnari¹⁴, K. Skovpen¹⁰⁷, P. Skubic¹¹¹, N. Skvorodnev²²,
 M. Slater¹⁷, T. Slavicek¹²⁷, K. Sliwa¹⁶¹, T.J. Sloan⁷¹, J. Sloper²⁹, V. Smakhtin¹⁷¹, S.Yu. Smirnov⁹⁶,
 L.N. Smirnova⁹⁷, O. Smirnova⁷⁹, B.C. Smith⁵⁷, D. Smith¹⁴³, K.M. Smith⁵³, M. Smizanska⁷¹,
 K. Smolek¹²⁷, A.A. Snesarev⁹⁴, S.W. Snow⁸², J. Snow¹¹¹, J. Snuverink¹⁰⁵, S. Snyder²⁴, M. Soares^{124a},
 R. Sobie^{169,k}, J. Sodomka¹²⁷, A. Soffer¹⁵³, C.A. Solans¹⁶⁷, M. Solar¹²⁷, J. Solc¹²⁷, E. Soldatov⁹⁶,
 U. Soldevila¹⁶⁷, E. Solfaroli Camillocci^{132a,132b}, A.A. Solodkov¹²⁸, O.V. Solovyanov¹²⁸, J. Sondericker²⁴,
 N. Soni², V. Sopko¹²⁷, B. Sopko¹²⁷, M. Sorbi^{89a,89b}, M. Sosebee⁷, A. Soukharev¹⁰⁷, S. Spagnolo^{72a,72b},
 F. Spanò⁷⁶, R. Spighi^{19a}, G. Spigo²⁹, F. Spila^{132a,132b}, E. Spiriti^{134a}, R. Spiwoks²⁹, M. Spousta¹²⁶,

T. Spreitzer¹⁵⁸, B. Spurlock⁷, R.D. St. Denis⁵³, T. Stahl¹⁴¹, J. Stahlman¹²⁰, R. Stamen^{58a}, E. Stanecka²⁹, R.W. Stanek⁵, C. Stanescu^{134a}, S. Stapnes¹¹⁷, E.A. Starchenko¹²⁸, J. Stark⁵⁵, P. Staroba¹²⁵, P. Starovoitov⁹¹, A. Staude⁹⁸, P. Stavina^{144a}, G. Stavropoulos¹⁴, G. Steele⁵³, P. Steinbach⁴³, P. Steinberg²⁴, I. Stekl¹²⁷, B. Stelzer¹⁴², H.J. Stelzer⁸⁸, O. Stelzer-Chilton^{159a}, H. Stenzel⁵², K. Stevenson⁷⁵, G.A. Stewart²⁹, J.A. Stillings²⁰, T. Stockmanns²⁰, M.C. Stockton²⁹, K. Stoerig⁴⁸, G. Stoica^{25a}, S. Stonjek⁹⁹, P. Strachota¹²⁶, A.R. Stradling⁷, A. Straessner⁴³, J. Strandberg¹⁴⁷, S. Strandberg^{146a,146b}, A. Strandlie¹¹⁷, M. Strang¹⁰⁹, E. Strauss¹⁴³, M. Strauss¹¹¹, P. Strizenec^{144b}, R. Ströhmer¹⁷³, D.M. Strom¹¹⁴, J.A. Strong^{76,*}, R. Stroynowski³⁹, J. Strube¹²⁹, B. Stugu¹³, I. Stumer^{24,*}, J. Stupak¹⁴⁸, P. Sturm¹⁷⁴, D.A. Soh^{151,r}, D. Su¹⁴³, H.S. Subramania², A. Succurro¹¹, Y. Sugaya¹¹⁶, T. Sugimoto¹⁰¹, C. Suhr¹⁰⁶, K. Suita⁶⁷, M. Suk¹²⁶, V.V. Sulim⁹⁴, S. Sultansoy^{3d}, T. Sumida²⁹, X. Sun⁵⁵, J.E. Sundermann⁴⁸, K. Suruliz¹³⁹, S. Sushkov¹¹, G. Susinno^{36a,36b}, M.R. Sutton¹⁴⁹, Y. Suzuki⁶⁶, Y. Suzuki⁶⁷, M. Svatos¹²⁵, Yu.M. Sviridov¹²⁸, S. Swedish¹⁶⁸, I. Sykora^{144a}, T. Sykora¹²⁶, B. Szeless²⁹, J. Sánchez¹⁶⁷, D. Ta¹⁰⁵, K. Tackmann⁴¹, A. Taffard¹⁶³, R. Tafirout^{159a}, N. Taiblum¹⁵³, Y. Takahashi¹⁰¹, H. Takai²⁴, R. Takashima⁶⁹, H. Takeda⁶⁷, T. Takeshita¹⁴⁰, M. Talby⁸³, A. Talyshev¹⁰⁷, M.C. Tamsett²⁴, J. Tanaka¹⁵⁵, R. Tanaka¹¹⁵, S. Tanaka¹³¹, S. Tanaka⁶⁶, Y. Tanaka¹⁰⁰, K. Tani⁶⁷, N. Tannoury⁸³, G.P. Tappern²⁹, S. Tapprogge⁸¹, D. Tardif¹⁵⁸, S. Tarem¹⁵², F. Tarrade²⁸, G.F. Tartarelli^{89a}, P. Tas¹²⁶, M. Tasevsky¹²⁵, E. Tassi^{36a,36b}, M. Tatarkhanov¹⁴, Y. Tayalati^{135d}, C. Taylor⁷⁷, F.E. Taylor⁹², G.N. Taylor⁸⁶, W. Taylor^{159b}, M. Teinturier¹¹⁵, M. Teixeira Dias Castanheira⁷⁵, P. Teixeira-Dias⁷⁶, K.K. Temming⁴⁸, H. Ten Kate²⁹, P.K. Teng¹⁵¹, S. Terada⁶⁶, K. Terashi¹⁵⁵, J. Terron⁸⁰, M. Terwort^{41,p}, M. Testa⁴⁷, R.J. Teuscher^{158,k}, J. Thadome¹⁷⁴, J. Therhaag²⁰, T. Theveneaux-Pelzer⁷⁸, M. Thioye¹⁷⁵, S. Thoma⁴⁸, J.P. Thomas¹⁷, E.N. Thompson⁸⁴, P.D. Thompson¹⁷, P.D. Thompson¹⁵⁸, A.S. Thompson⁵³, E. Thomson¹²⁰, M. Thomson²⁷, R.P. Thun⁸⁷, F. Tian³⁴, T. Tic¹²⁵, V.O. Tikhomirov⁹⁴, Y.A. Tikhonov¹⁰⁷, C.J.W.P. Timmermans¹⁰⁴, P. Tipton¹⁷⁵, F.J. Tique Aires Viegas²⁹, S. Tisserant⁸³, J. Tobias⁴⁸, B. Toczec³⁷, T. Todorov⁴, S. Todorova-Nova¹⁶¹, B. Toggerson¹⁶³, J. Tojo⁶⁶, S. Tokár^{144a}, K. Tokunaga⁶⁷, K. Tokushuku⁶⁶, K. Tollefson⁸⁸, M. Tomoto¹⁰¹, L. Tompkins¹⁴, K. Toms¹⁰³, G. Tong^{32a}, A. Tonoyan¹³, C. Topfel¹⁶, N.D. Topilin⁶⁵, I. Torchiani²⁹, E. Torrence¹¹⁴, H. Torres⁷⁸, E. Torró Pastor¹⁶⁷, J. Toth^{83,x}, F. Touchard⁸³, D.R. Tovey¹³⁹, D. Traynor⁷⁵, T. Trefzger¹⁷³, L. Tremblet²⁹, A. Tricoli²⁹, I.M. Trigger^{159a}, S. Trincaz-Duvoid⁷⁸, T.N. Trinh⁷⁸, M.F. Tripiana⁷⁰, W. Trischuk¹⁵⁸, A. Trivedi^{24,w}, B. Trocmé⁵⁵, C. Troncon^{89a}, M. Trotter-McDonald¹⁴², A. Trzupek³⁸, C. Tsarouchas²⁹, J.C.-L. Tseng¹¹⁸, M. Tsiakiris¹⁰⁵, P.V. Tsiareshka⁹⁰, D. Tsionou⁴, G. Tsipolitis⁹, V. Tsiskaridze⁴⁸, E.G. Tskhadadze⁵¹, I.I. Tsukerman⁹⁵, V. Tsulaia¹⁴, J.-W. Tsung²⁰, S. Tsuno⁶⁶, D. Tsybychev¹⁴⁸, A. Tua¹³⁹, J.M. Tuggle³⁰, M. Turala³⁸, D. Turecek¹²⁷, I. Turk Cakir^{3e}, E. Turlay¹⁰⁵, R. Turra^{89a,89b}, P.M. Tuts³⁴, A. Tykhonov⁷⁴, M. Tylmad^{146a,146b}, M. Tyndel¹²⁹, H. Tyrvainen²⁹, G. Tzanakos⁸, K. Uchida²⁰, I. Ueda¹⁵⁵, R. Ueno²⁸, M. Uglund¹³, M. Uhlenbrock²⁰, M. Uhrmacher⁵⁴, F. Ukegawa¹⁶⁰, G. Unal²⁹, D.G. Underwood⁵, A. Undrus²⁴, G. Unel¹⁶³, Y. Unno⁶⁶, D. Urbaniec³⁴, E. Urkovsky¹⁵³, P. Urrejola^{31a}, G. Usai⁷, M. Uslenghi^{119a,119b}, L. Vacavant⁸³, V. Vacek¹²⁷, B. Vachon⁸⁵, S. Vahsen¹⁴, J. Valenta¹²⁵, P. Valente^{132a}, S. Valentini^{19a,19b}, S. Valkar¹²⁶, E. Valladolid Gallego¹⁶⁷, S. Vallecorsa¹⁵², J.A. Valls Ferrer¹⁶⁷, H. van der Graaf¹⁰⁵, E. van der Kraaij¹⁰⁵, R. Van Der Leeuw¹⁰⁵, E. van der Poel¹⁰⁵, D. van der Ster²⁹, B. Van Eijk¹⁰⁵, N. van Eldik⁸⁴, P. van Gemmeren⁵, Z. van Kesteren¹⁰⁵, I. van Vulpen¹⁰⁵, W. Vandelli²⁹, G. Vandoni²⁹, A. Vaniachine⁵, P. Vankov⁴¹, F. Vannucci⁷⁸, F. Varela Rodriguez²⁹, R. Vari^{132a}, D. Varouchas¹⁴, A. Vartapetian⁷, K.E. Varvell¹⁵⁰, V.I. Vassilakopoulos⁵⁶, F. Vazeille³³, G. Vegni^{89a,89b}, J.J. Veillet¹¹⁵, C. Vellidis⁸, F. Veloso^{124a}, R. Veness²⁹, S. Veneziano^{132a}, A. Ventura^{72a,72b}, D. Ventura¹³⁸, M. Venturi⁴⁸, N. Venturi¹⁶, V. Vercesi^{119a}, M. Verducci¹³⁸, W. Verkerke¹⁰⁵, J.C. Vermeulen¹⁰⁵, A. Vest⁴³, M.C. Vetterli^{142,e}, I. Vichou¹⁶⁵, T. Vickey^{145b,aa}, O.E. Vickey Boeriu^{145b}, G.H.A. Viehhauser¹¹⁸, S. Viel¹⁶⁸, M. Villa^{19a,19b}, M. Villaplana Perez¹⁶⁷, E. Vilucchi⁴⁷, M.G. Vincker²⁸, E. Vinek²⁹, V.B. Vinogradov⁶⁵, M. Virchaux^{136,*}, J. Virzi¹⁴, O. Vitells¹⁷¹, M. Viti⁴¹, I. Vivarelli⁴⁸, F. Vives Vaque², S. Vlachos⁹, M. Vlasak¹²⁷, N. Vlasov²⁰, A. Vogel²⁰, P. Vokac¹²⁷, G. Volpi⁴⁷, M. Volpi⁸⁶, G. Volpini^{89a}, H. von der Schmitt⁹⁹, J. von Loeben⁹⁹, H. von Radziewski⁴⁸, E. von Toerne²⁰, V. Vorobel¹²⁶, A.P. Vorobiev¹²⁸, V. Vorwerk¹¹, M. Vos¹⁶⁷, R. Voss²⁹, T.T. Voss¹⁷⁴, J.H. Vosseveld⁷³, N. Vranjes^{12a}, M. Vranjes Milosavljevic¹⁰⁵, V. Vrba¹²⁵, M. Vreeswijk¹⁰⁵, T. Vu Anh⁸¹, R. Vuillermet²⁹, I. Vukotic¹¹⁵, W. Wagner¹⁷⁴, P. Wagner¹²⁰, H. Wahlen¹⁷⁴, J. Wakabayashi¹⁰¹, J. Walbersloh⁴², S. Walch⁸⁷, J. Walder⁷¹, R. Walker⁹⁸, W. Walkowiak¹⁴¹, R. Wall¹⁷⁵, P. Waller⁷³, C. Wang⁴⁴, H. Wang¹⁷², H. Wang^{32b,ab},

J. Wang¹⁵¹, J. Wang^{32d}, J.C. Wang¹³⁸, R. Wang¹⁰³, S.M. Wang¹⁵¹, A. Warburton⁸⁵, C.P. Ward²⁷, D.R. Wardrope⁷⁷, M. Warsinsky⁴⁸, P.M. Watkins¹⁷, A.T. Watson¹⁷, M.F. Watson¹⁷, G. Watts¹³⁸, S. Watts⁸², A.T. Waugh¹⁵⁰, B.M. Waugh⁷⁷, J. Weber⁴², M. Weber¹²⁹, M.S. Weber¹⁶, P. Weber⁵⁴, A.R. Weidberg¹¹⁸, P. Weigell⁹⁹, J. Weingarten⁵⁴, C. Weiser⁴⁸, H. Wellenstein²², P.S. Wells²⁹, M. Wen⁴⁷, T. Wenaus²⁴, S. Wendler¹²³, Z. Weng^{151,r}, T. Wengler²⁹, S. Wenig²⁹, N. Wermes²⁰, M. Werner⁴⁸, P. Werner²⁹, M. Werth¹⁶³, M. Wessels^{58a}, C. Weydert⁵⁵, K. Whalen²⁸, S.J. Wheeler-Ellis¹⁶³, S.P. Whitaker²¹, A. White⁷, M.J. White⁸⁶, S.R. Whitehead¹¹⁸, D. Whiteson¹⁶³, D. Whittington⁶¹, F. Wicek¹¹⁵, D. Wicke¹⁷⁴, F.J. Wickens¹²⁹, W. Wiedenmann¹⁷², M. Wielers¹²⁹, P. Wienemann²⁰, C. Wiglesworth⁷⁵, L.A.M. Wiik⁴⁸, P.A. Wijeratne⁷⁷, A. Wildauer¹⁶⁷, M.A. Wildt^{41,p}, I. Wilhelm¹²⁶, H.G. Wilkens²⁹, J.Z. Will⁹⁸, E. Williams³⁴, H.H. Williams¹²⁰, W. Willis³⁴, S. Willocq⁸⁴, J.A. Wilson¹⁷, M.G. Wilson¹⁴³, A. Wilson⁸⁷, I. Wingerter-Seez⁴, S. Winkelmann⁴⁸, F. Winklmeier²⁹, M. Wittgen¹⁴³, M.W. Wolter³⁸, H. Wolters^{124a,i}, W.C. Wong⁴⁰, G. Wooden¹¹⁸, B.K. Wosiek³⁸, J. Wotschack²⁹, M.J. Woudstra⁸⁴, K. Wraight⁵³, C. Wright⁵³, B. Wrona⁷³, S.L. Wu¹⁷², X. Wu⁴⁹, Y. Wu^{32b,ac}, E. Wulf³⁴, R. Wunstorf⁴², B.M. Wynne⁴⁵, L. Xaplanteris⁹, S. Xella³⁵, S. Xie⁴⁸, Y. Xie^{32a}, C. Xu^{32b,ad}, D. Xu¹³⁹, G. Xu^{32a}, B. Yabsley¹⁵⁰, S. Yacoob^{145b}, M. Yamada⁶⁶, H. Yamaguchi¹⁵⁵, A. Yamamoto⁶⁶, K. Yamamoto⁶⁴, S. Yamamoto¹⁵⁵, T. Yamamura¹⁵⁵, T. Yamanaka¹⁵⁵, J. Yamaoka⁴⁴, T. Yamazaki¹⁵⁵, Y. Yamazaki⁶⁷, Z. Yan²¹, H. Yang⁸⁷, U.K. Yang⁸², Y. Yang⁶¹, Y. Yang^{32a}, Z. Yang^{146a,146b}, S. Yanush⁹¹, Y. Yao¹⁴, Y. Yasu⁶⁶, G.V. Ybeles Smit¹³⁰, J. Ye³⁹, S. Ye²⁴, M. Yilmaz^{3c}, R. Yoosofmiya¹²³, K. Yorita¹⁷⁰, R. Yoshida⁵, C. Young¹⁴³, S. Youssef²¹, D. Yu²⁴, J. Yu⁷, J. Yu^{32c,ad}, L. Yuan^{32a,ae}, A. Yurkewicz¹⁴⁸, V.G. Zaets¹²⁸, R. Zaidan⁶³, A.M. Zaitsev¹²⁸, Z. Zajacova²⁹, Yo.K. Zalite¹²¹, L. Zanello^{132a,132b}, P. Zarzhitsky³⁹, A. Zaytsev¹⁰⁷, C. Zeitnitz¹⁷⁴, M. Zeller¹⁷⁵, M. Zeman¹²⁵, A. Zemla³⁸, C. Zender²⁰, O. Zenin¹²⁸, T. Ženiš^{144a}, Z. Zenonos^{122a,122b}, S. Zenz¹⁴, D. Zerwas¹¹⁵, G. Zevi della Porta⁵⁷, Z. Zhan^{32d}, D. Zhang^{32b,ab}, H. Zhang⁸⁸, J. Zhang⁵, X. Zhang^{32d}, Z. Zhang¹¹⁵, L. Zhao¹⁰⁸, T. Zhao¹³⁸, Z. Zhao^{32b}, A. Zhemchugov⁶⁵, S. Zheng^{32a}, J. Zhong^{151,af}, B. Zhou⁸⁷, N. Zhou¹⁶³, Y. Zhou¹⁵¹, C.G. Zhu^{32d}, H. Zhu⁴¹, J. Zhu⁸⁷, Y. Zhu¹⁷², X. Zhuang⁹⁸, V. Zhuravlov⁹⁹, D. Zieminska⁶¹, R. Zimmermann²⁰, S. Zimmermann²⁰, S. Zimmermann⁴⁸, M. Ziolkowski¹⁴¹, R. Zitoun⁴, L. Živković³⁴, V.V. Zmouchko^{128,*}, G. Zobernig¹⁷², A. Zoccoli^{19a,19b}, Y. Zolnierowski⁴, A. Zsenei²⁹, M. zur Nedden¹⁵, V. Zutshi¹⁰⁶, L. Zwalinski²⁹

¹ University at Albany, Albany, NY, United States

² Department of Physics, University of Alberta, Edmonton, AB, Canada

³ (a) Department of Physics, Ankara University, Ankara; (b) Department of Physics, Dumlupinar University, Kutahya; (c) Department of Physics, Gazi University, Ankara; (d) Division of Physics, TOBB University of Economics and Technology, Ankara; (e) Turkish Atomic Energy Authority, Ankara, Turkey

⁴ LAPP, CNRS/IN2P3 and Université de Savoie, Annecy-le-Vieux, France

⁵ High Energy Physics Division, Argonne National Laboratory, Argonne, IL, United States

⁶ Department of Physics, University of Arizona, Tucson, AZ, United States

⁷ Department of Physics, The University of Texas at Arlington, Arlington, TX, United States

⁸ Physics Department, University of Athens, Athens, Greece

⁹ Physics Department, National Technical University of Athens, Zografou, Greece

¹⁰ Institute of Physics, Azerbaijan Academy of Sciences, Baku, Azerbaijan

¹¹ Institut de Física d'Altes Energies and Departament de Física de la Universitat Autònoma de Barcelona and ICREA, Barcelona, Spain

¹² (a) Institute of Physics, University of Belgrade, Belgrade; (b) Vinca Institute of Nuclear Sciences, Belgrade, Serbia

¹³ Department for Physics and Technology, University of Bergen, Bergen, Norway

¹⁴ Physics Division, Lawrence Berkeley National Laboratory and University of California, Berkeley, CA, United States

¹⁵ Department of Physics, Humboldt University, Berlin, Germany

¹⁶ Albert Einstein Center for Fundamental Physics and Laboratory for High Energy Physics, University of Bern, Bern, Switzerland

¹⁷ School of Physics and Astronomy, University of Birmingham, Birmingham, United Kingdom

¹⁸ (a) Department of Physics, Bogazici University, Istanbul; (b) Division of Physics, Dogus University, Istanbul; (c) Department of Physics Engineering, Gaziantep University, Gaziantep;

(d) Department of Physics, Istanbul Technical University, Istanbul, Turkey

¹⁹ (a) INFN Sezione di Bologna; (b) Dipartimento di Fisica, Università di Bologna, Bologna, Italy

²⁰ Physikalisches Institut, University of Bonn, Bonn, Germany

²¹ Department of Physics, Boston University, Boston, MA, United States

²² Department of Physics, Brandeis University, Waltham, MA, United States

²³ (a) Universidade Federal do Rio De Janeiro COPPE/EE/IF, Rio de Janeiro; (b) Federal University of Juiz de Fora (UFJF), Juiz de Fora; (c) Federal University of Sao Joao del Rei (UFSJ), Sao Joao del Rei; (d) Instituto de Física, Universidade de Sao Paulo, Sao Paulo, Brazil

²⁴ Physics Department, Brookhaven National Laboratory, Upton, NY, United States

²⁵ (a) National Institute of Physics and Nuclear Engineering, Bucharest; (b) University Politehnica Bucharest, Bucharest; (c) West University in Timisoara, Timisoara, Romania

²⁶ Departamento de Física, Universidad de Buenos Aires, Buenos Aires, Argentina

²⁷ Cavendish Laboratory, University of Cambridge, Cambridge, United Kingdom

²⁸ Department of Physics, Carleton University, Ottawa, ON, Canada

²⁹ CERN, Geneva, Switzerland

³⁰ Enrico Fermi Institute, University of Chicago, Chicago, IL, United States

³¹ (a) Departamento de Física, Pontificia Universidad Católica de Chile, Santiago; (b) Departamento de Física, Universidad Técnica Federico Santa María, Valparaíso, Chile

³² (a) Institute of High Energy Physics, Chinese Academy of Sciences, Beijing; (b) Department of Modern Physics, University of Science and Technology of China, Anhui; (c) Department of Physics, Nanjing University, Jiangsu; (d) High Energy Physics Group, Shandong University, Shandong, China

³³ Laboratoire de Physique Corpusculaire, Clermont Université and Université Blaise Pascal and CNRS/IN2P3, Aubiere Cedex, France

- ³⁴ Nevis Laboratory, Columbia University, Irvington, NY, United States
- ³⁵ Niels Bohr Institute, University of Copenhagen, Kobenhavn, Denmark
- ³⁶ ^(a) INFN Gruppo Collegato di Cosenza; ^(b) Dipartimento di Fisica, Università della Calabria, Arcavata di Rende, Italy
- ³⁷ Faculty of Physics and Applied Computer Science, AGH-University of Science and Technology, Krakow, Poland
- ³⁸ The Henryk Niewodniczanski Institute of Nuclear Physics, Polish Academy of Sciences, Krakow, Poland
- ³⁹ Physics Department, Southern Methodist University, Dallas, TX, United States
- ⁴⁰ Physics Department, University of Texas at Dallas, Richardson, TX, United States
- ⁴¹ DESY, Hamburg and Zeuthen, Germany
- ⁴² Institut für Experimentelle Physik IV, Technische Universität Dortmund, Dortmund, Germany
- ⁴³ Institut für Kern- und Teilchenphysik, Technical University Dresden, Dresden, Germany
- ⁴⁴ Department of Physics, Duke University, Durham, NC, United States
- ⁴⁵ SUPA – School of Physics and Astronomy, University of Edinburgh, Edinburgh, United Kingdom
- ⁴⁶ Fachhochschule Wiener Neustadt, Johannes Gutenbergstrasse 3, 2700 Wiener Neustadt, Austria
- ⁴⁷ INFN Laboratori Nazionali di Frascati, Frascati, Italy
- ⁴⁸ Fakultät für Mathematik und Physik, Albert-Ludwigs-Universität, Freiburg i.Br., Germany
- ⁴⁹ Section de Physique, Université de Genève, Geneva, Switzerland
- ⁵⁰ ^(a) INFN Sezione di Genova; ^(b) Dipartimento di Fisica, Università di Genova, Genova, Italy
- ⁵¹ Institute of Physics and HEP Institute, Georgian Academy of Sciences and Tbilisi State University, Tbilisi, Georgia
- ⁵² Il Physikalisches Institut, Justus-Liebig-Universität Giessen, Giessen, Germany
- ⁵³ SUPA – School of Physics and Astronomy, University of Glasgow, Glasgow, United Kingdom
- ⁵⁴ Il Physikalisches Institut, Georg-August-Universität, Göttingen, Germany
- ⁵⁵ Laboratoire de Physique Subatomique et de Cosmologie, Université Joseph Fourier and CNRS/IN2P3 and Institut National Polytechnique de Grenoble, Grenoble, France
- ⁵⁶ Department of Physics, Hampton University, Hampton, VA, United States
- ⁵⁷ Laboratory for Particle Physics and Cosmology, Harvard University, Cambridge, MA, United States
- ⁵⁸ ^(a) Kirchhoff-Institut für Physik, Ruprecht-Karls-Universität Heidelberg, Heidelberg; ^(b) Physikalisches Institut, Ruprecht-Karls-Universität Heidelberg, Mannheim, Germany; ^(c) ZITI Institut für technische Informatik, Ruprecht-Karls-Universität Heidelberg, Mannheim, Germany
- ⁵⁹ Faculty of Science, Hiroshima University, Hiroshima, Japan
- ⁶⁰ Faculty of Applied Information Science, Hiroshima Institute of Technology, Hiroshima, Japan
- ⁶¹ Department of Physics, Indiana University, Bloomington, IN, United States
- ⁶² Institut für Astro- und Teilchenphysik, Leopold-Franzens-Universität, Innsbruck, Austria
- ⁶³ University of Iowa, Iowa City, IA, United States
- ⁶⁴ Department of Physics and Astronomy, Iowa State University, Ames, IA, United States
- ⁶⁵ Joint Institute for Nuclear Research, JINR Dubna, Dubna, Russia
- ⁶⁶ KEK, High Energy Accelerator Research Organization, Tsukuba, Japan
- ⁶⁷ Graduate School of Science, Kobe University, Kobe, Japan
- ⁶⁸ Faculty of Science, Kyoto University, Kyoto, Japan
- ⁶⁹ Kyoto University of Education, Kyoto, Japan
- ⁷⁰ Instituto de Física La Plata, Universidad Nacional de La Plata and CONICET, La Plata, Argentina
- ⁷¹ Physics Department, Lancaster University, Lancaster, United Kingdom
- ⁷² ^(a) INFN Sezione di Lecce; ^(b) Dipartimento di Fisica, Università del Salento, Lecce, Italy
- ⁷³ Oliver Lodge Laboratory, University of Liverpool, Liverpool, United Kingdom
- ⁷⁴ Department of Physics, Jožef Stefan Institute and University of Ljubljana, Ljubljana, Slovenia
- ⁷⁵ Department of Physics, Queen Mary University of London, London, United Kingdom
- ⁷⁶ Department of Physics, Royal Holloway University of London, Surrey, United Kingdom
- ⁷⁷ Department of Physics and Astronomy, University College London, London, United Kingdom
- ⁷⁸ Laboratoire de Physique Nucléaire et de Hautes Energies, UPMC and Université Paris-Diderot and CNRS/IN2P3, Paris, France
- ⁷⁹ Fysiska institutionen, Lunds universitet, Lund, Sweden
- ⁸⁰ Departamento de Física Teórica C-15, Universidad Autónoma de Madrid, Madrid, Spain
- ⁸¹ Institut für Physik, Universität Mainz, Mainz, Germany
- ⁸² School of Physics and Astronomy, University of Manchester, Manchester, United Kingdom
- ⁸³ CPPM, Aix-Marseille Université and CNRS/IN2P3, Marseille, France
- ⁸⁴ Department of Physics, University of Massachusetts, Amherst, MA, United States
- ⁸⁵ Department of Physics, McGill University, Montreal, QC, Canada
- ⁸⁶ School of Physics, University of Melbourne, Victoria, Australia
- ⁸⁷ Department of Physics, The University of Michigan, Ann Arbor, MI, United States
- ⁸⁸ Department of Physics and Astronomy, Michigan State University, East Lansing, MI, United States
- ⁸⁹ ^(a) INFN Sezione di Milano; ^(b) Dipartimento di Fisica, Università di Milano, Milano, Italy
- ⁹⁰ B.I. Stepanov Institute of Physics, National Academy of Sciences of Belarus, Minsk, Belarus
- ⁹¹ National Scientific and Educational Centre for Particle and High Energy Physics, Minsk, Belarus
- ⁹² Department of Physics, Massachusetts Institute of Technology, Cambridge, MA, United States
- ⁹³ Group of Particle Physics, University of Montreal, Montreal, QC, Canada
- ⁹⁴ P.N. Lebedev Institute of Physics, Academy of Sciences, Moscow, Russia
- ⁹⁵ Institute for Theoretical and Experimental Physics (ITEP), Moscow, Russia
- ⁹⁶ Moscow Engineering and Physics Institute (MEPhI), Moscow, Russia
- ⁹⁷ Skobeltsyn Institute of Nuclear Physics, Lomonosov Moscow State University, Moscow, Russia
- ⁹⁸ Fakultät für Physik, Ludwig-Maximilians-Universität München, München, Germany
- ⁹⁹ Max-Planck-Institut für Physik (Werner-Heisenberg-Institut), München, Germany
- ¹⁰⁰ Nagasaki Institute of Applied Science, Nagasaki, Japan
- ¹⁰¹ Graduate School of Science, Nagoya University, Nagoya, Japan
- ¹⁰² ^(a) INFN Sezione di Napoli; ^(b) Dipartimento di Scienze Fisiche, Università di Napoli, Napoli, Italy
- ¹⁰³ Department of Physics and Astronomy, University of New Mexico, Albuquerque, NM, United States
- ¹⁰⁴ Institute for Mathematics, Astrophysics and Particle Physics, Radboud University Nijmegen/Nikhef, Nijmegen, Netherlands
- ¹⁰⁵ Nikhef National Institute for Subatomic Physics and University of Amsterdam, Amsterdam, Netherlands
- ¹⁰⁶ Department of Physics, Northern Illinois University, DeKalb, IL, United States
- ¹⁰⁷ Budker Institute of Nuclear Physics (BINP), Novosibirsk, Russia
- ¹⁰⁸ Department of Physics, New York University, New York, NY, United States
- ¹⁰⁹ Ohio State University, Columbus, OH, United States
- ¹¹⁰ Faculty of Science, Okayama University, Okayama, Japan
- ¹¹¹ Homer L. Dodge Department of Physics and Astronomy, University of Oklahoma, Norman, OK, United States

- ¹¹² Department of Physics, Oklahoma State University, Stillwater, OK, United States
¹¹³ Palacký University, RCPTM, Olomouc, Czech Republic
¹¹⁴ Center for High Energy Physics, University of Oregon, Eugene, OR, United States
¹¹⁵ LAL, Univ. Paris-Sud and CNRS/IN2P3, Orsay, France
¹¹⁶ Graduate School of Science, Osaka University, Osaka, Japan
¹¹⁷ Department of Physics, University of Oslo, Oslo, Norway
¹¹⁸ Department of Physics, Oxford University, Oxford, United Kingdom
¹¹⁹ ^(a) INFN Sezione di Pavia; ^(b) Dipartimento di Fisica Nucleare e Teorica, Università di Pavia, Pavia, Italy
¹²⁰ Department of Physics, University of Pennsylvania, Philadelphia, PA, United States
¹²¹ Petersburg Nuclear Physics Institute, Gatchina, Russia
¹²² ^(a) INFN Sezione di Pisa; ^(b) Dipartimento di Fisica E. Fermi, Università di Pisa, Pisa, Italy
¹²³ Department of Physics and Astronomy, University of Pittsburgh, Pittsburgh, PA, United States
¹²⁴ ^(a) Laboratório de Instrumentação e Física Experimental de Partículas – LIP, Lisboa, Portugal; ^(b) Departamento de Física Teórica y del Cosmos and CAFPE, Universidad de Granada, Granada, Spain
¹²⁵ Institute of Physics, Academy of Sciences of the Czech Republic, Praha, Czech Republic
¹²⁶ Faculty of Mathematics and Physics, Charles University in Prague, Praha, Czech Republic
¹²⁷ Czech Technical University in Prague, Praha, Czech Republic
¹²⁸ State Research Center Institute for High Energy Physics, Protvino, Russia
¹²⁹ Particle Physics Department, Rutherford Appleton Laboratory, Didcot, United Kingdom
¹³⁰ Physics Department, University of Regina, Regina, SK, Canada
¹³¹ Ritsumeikan University, Kusatsu, Shiga, Japan
¹³² ^(a) INFN Sezione di Roma I; ^(b) Dipartimento di Fisica, Università La Sapienza, Roma, Italy
¹³³ ^(a) INFN Sezione di Roma Tor Vergata; ^(b) Dipartimento di Fisica, Università di Roma Tor Vergata, Roma, Italy
¹³⁴ ^(a) INFN Sezione di Roma Tre; ^(b) Dipartimento di Fisica, Università Roma Tre, Roma, Italy
¹³⁵ ^(a) Faculté des Sciences Ain Chock, Réseau Universitaire de Physique des Hautes Energies – Université Hassan II, Casablanca; ^(b) Centre National de l’Energie des Sciences Techniques Nucleaires, Rabat; ^(c) Université Cadi Ayyad, Faculté des sciences Semlalia Département de Physique, B.P. 2390 Marrakech 40000; ^(d) Faculté des Sciences, Université Mohamed Premier and LPTPM, Oujda; ^(e) Faculté des Sciences, Université Mohammed V, Rabat, Morocco
¹³⁶ DSM/IRFU (Institut de Recherches sur les Lois Fondamentales de l’Univers), CEA Saclay (Commissariat à l’Energie Atomique), Gif-sur-Yvette, France
¹³⁷ Santa Cruz Institute for Particle Physics, University of California Santa Cruz, Santa Cruz, CA, United States
¹³⁸ Department of Physics, University of Washington, Seattle, WA, United States
¹³⁹ Department of Physics and Astronomy, University of Sheffield, Sheffield, United Kingdom
¹⁴⁰ Department of Physics, Shinshu University, Nagano, Japan
¹⁴¹ Fachbereich Physik, Universität Siegen, Siegen, Germany
¹⁴² Department of Physics, Simon Fraser University, Burnaby, BC, Canada
¹⁴³ SLAC National Accelerator Laboratory, Stanford, CA, United States
¹⁴⁴ ^(a) Faculty of Mathematics, Physics & Informatics, Comenius University, Bratislava; ^(b) Department of Subnuclear Physics, Institute of Experimental Physics of the Slovak Academy of Sciences, Kosice, Slovak Republic
¹⁴⁵ ^(a) Department of Physics, University of Johannesburg, Johannesburg; ^(b) School of Physics, University of the Witwatersrand, Johannesburg, South Africa
¹⁴⁶ ^(a) Department of Physics, Stockholm University; ^(b) The Oskar Klein Centre, Stockholm, Sweden
¹⁴⁷ Physics Department, Royal Institute of Technology, Stockholm, Sweden
¹⁴⁸ Department of Physics and Astronomy, Stony Brook University, Stony Brook, NY, United States
¹⁴⁹ Department of Physics and Astronomy, University of Sussex, Brighton, United Kingdom
¹⁵⁰ School of Physics, University of Sydney, Sydney, Australia
¹⁵¹ Institute of Physics, Academia Sinica, Taipei, Taiwan
¹⁵² Department of Physics, Technion: Israel Inst. of Technology, Haifa, Israel
¹⁵³ Raymond and Beverly Sackler School of Physics and Astronomy, Tel Aviv University, Tel Aviv, Israel
¹⁵⁴ Department of Physics, Aristotle University of Thessaloniki, Thessaloniki, Greece
¹⁵⁵ International Center for Elementary Particle Physics and Department of Physics, The University of Tokyo, Tokyo, Japan
¹⁵⁶ Graduate School of Science and Technology, Tokyo Metropolitan University, Tokyo, Japan
¹⁵⁷ Department of Physics, Tokyo Institute of Technology, Tokyo, Japan
¹⁵⁸ Department of Physics, University of Toronto, Toronto, ON, Canada
¹⁵⁹ ^(a) TRIUMF, Vancouver, BC; ^(b) Department of Physics and Astronomy, York University, Toronto, ON, Canada
¹⁶⁰ Institute of Pure and Applied Sciences, University of Tsukuba, Ibaraki, Japan
¹⁶¹ Science and Technology Center, Tufts University, Medford, MA, United States
¹⁶² Centro de Investigaciones, Universidad Antonio Narino, Bogota, Colombia
¹⁶³ Department of Physics and Astronomy, University of California Irvine, Irvine, CA, United States
¹⁶⁴ ^(a) INFN Gruppo Collegato di Udine; ^(b) ICTP, Trieste; ^(c) Dipartimento di Fisica, Università di Udine, Udine, Italy
¹⁶⁵ Department of Physics, University of Illinois, Urbana, IL, United States
¹⁶⁶ Department of Physics and Astronomy, University of Uppsala, Uppsala, Sweden
¹⁶⁷ Instituto de Física Corpuscular (IFIC) and Departamento de Física Atómica, Molecular y Nuclear and Departamento de Ingeniería Electrónica and Instituto de Microelectrónica de Barcelona (IMB-CNM), University of Valencia and CSIC, Valencia, Spain
¹⁶⁸ Department of Physics, University of British Columbia, Vancouver, BC, Canada
¹⁶⁹ Department of Physics and Astronomy, University of Victoria, Victoria, BC, Canada
¹⁷⁰ Waseda University, Tokyo, Japan
¹⁷¹ Department of Particle Physics, The Weizmann Institute of Science, Rehovot, Israel
¹⁷² Department of Physics, University of Wisconsin, Madison, WI, United States
¹⁷³ Fakultät für Physik und Astronomie, Julius-Maximilians-Universität, Würzburg, Germany
¹⁷⁴ Fachbereich C Physik, Bergische Universität Wuppertal, Wuppertal, Germany
¹⁷⁵ Department of Physics, Yale University, New Haven, CT, United States
¹⁷⁶ Yerevan Physics Institute, Yerevan, Armenia
¹⁷⁷ Domaine scientifique de la Doua, Centre de Calcul CNRS/IN2P3, Villeurbanne Cedex, France

^a Also at Laboratório de Instrumentação e Física Experimental de Partículas – LIP, Lisboa, Portugal.

^b Also at Faculdade de Ciências and CFNUL, Universidade de Lisboa, Lisboa, Portugal.

^c Also at Particle Physics Department, Rutherford Appleton Laboratory, Didcot, United Kingdom.

^d Also at CPPM, Aix-Marseille Université and CNRS/IN2P3, Marseille, France.

^e Also at TRIUMF, Vancouver BC, Canada.

^f Also at Department of Physics, California State University, Fresno, CA, United States.

- ^g Also at Faculty of Physics and Applied Computer Science, AGH-University of Science and Technology, Krakow, Poland.
- ^h Also at Fermilab, Batavia, IL, United States.
- ⁱ Also at Department of Physics, University of Coimbra, Coimbra, Portugal.
- ^j Also at Università di Napoli Parthenope, Napoli, Italy.
- ^k Also at Institute of Particle Physics (IPP), Canada.
- ^l Also at Department of Physics, Middle East Technical University, Ankara, Turkey.
- ^m Also at Louisiana Tech University, Ruston, LA, United States.
- ⁿ Also at Group of Particle Physics, University of Montreal, Montreal, QC, Canada.
- ^o Also at Institute of Physics, Azerbaijan Academy of Sciences, Baku, Azerbaijan.
- ^p Also at Institut für Experimentalphysik, Universität Hamburg, Hamburg, Germany.
- ^q Also at Manhattan College, New York, NY, United States.
- ^r Also at School of Physics and Engineering, Sun Yat-sen University, Guanzhou, China.
- ^s Also at Academia Sinica Grid Computing, Institute of Physics, Academia Sinica, Taipei, Taiwan.
- ^t Also at High Energy Physics Group, Shandong University, Shandong, China.
- ^u Also at Section de Physique, Université de Genève, Geneva, Switzerland.
- ^v Also at Departamento de Física, Universidade de Minho, Braga, Portugal.
- ^w Also at Department of Physics and Astronomy, University of South Carolina, Columbia, SC, United States.
- ^x Also at KFKI Research Institute for Particle and Nuclear Physics, Budapest, Hungary.
- ^y Also at California Institute of Technology, Pasadena, CA, United States.
- ^z Also at Institute of Physics, Jagiellonian University, Krakow, Poland.
- ^{aa} Also at Department of Physics, Oxford University, Oxford, United Kingdom.
- ^{ab} Also at Institute of Physics, Academia Sinica, Taipei, Taiwan.
- ^{ac} Also at Department of Physics, The University of Michigan, Ann Arbor, MI, United States.
- ^{ad} Also at DSM/IRFU (Institut de Recherches sur les Lois Fondamentales de l'Univers), CEA Saclay (Commissariat à l'Energie Atomique), Gif-sur-Yvette, France.
- ^{ae} Also at Laboratoire de Physique Nucléaire et de Hautes Energies, UPMC and Université Paris-Diderot and CNRS/IN2P3, Paris, France.
- ^{af} Also at Department of Physics, Nanjing University, Jiangsu, China.
- * Deceased.