

# Multi-Particle Baryon Spectroscopy in Lattice Quantum Chromodynamics

Adrian Leigh Kiratidis

April 2012

A thesis submitted for the degree of Master of Philosophy  
of the University of Adelaide



THE UNIVERSITY  
*of* ADELAIDE

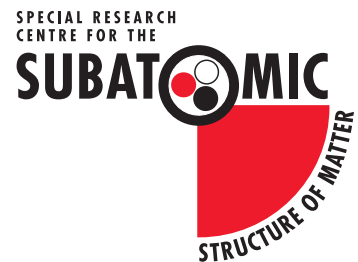



# Contents

<b>Abstract</b>	<b>xiii</b>
<b>Acknowledgements</b>	<b>xvii</b>
<b>1 Introduction</b>	<b>1</b>
1.1 Motivation . . . . .	2
1.2 Continuum QCD . . . . .	5
1.3 Gauge Invariance . . . . .	7
1.3.1 Fermion Action . . . . .	7
1.3.2 Gauge Action . . . . .	8
1.4 The Path-Integral Formalism . . . . .	9
1.4.1 Calculus with Grassmann Variables . . . . .	9
1.4.2 The Path Integral . . . . .	11
<b>2 QCD On the Lattice</b>	<b>15</b>
2.1 The Fermion Action on the Lattice . . . . .	15
2.1.1 The Naive Discretisation . . . . .	16
2.1.2 Wilson Fermions . . . . .	20
2.1.3 Improving the Fermion Action . . . . .	22
2.1.4 The Field Strength Tensor on the Lattice . . . . .	24
2.1.5 Mean Field Improvement . . . . .	28
2.1.6 The FLIC Fermion Action . . . . .	28
2.2 The Gauge Action on the Lattice . . . . .	30
2.2.1 Improving the Gauge Action . . . . .	32
<b>3 Spectroscopy in Lattice QCD</b>	<b>35</b>
3.1 Correlation Functions at the Baryon Level . . . . .	35
3.2 Interpolating Fields . . . . .	39
3.3 Correlation Functions at the Quark Level . . . . .	42

3.4	Propagators . . . . .	45
<b>4</b>	<b>Simulation Results</b>	<b>55</b>
4.1	The Even-Parity Proton . . . . .	56
4.1.1	Correlation Functions . . . . .	56
4.1.2	Effective Mass Plots . . . . .	59
4.2	The Odd-Parity $N^*$ . . . . .	62
4.2.1	Correlation Functions . . . . .	62
4.2.2	Effective Mass Plots . . . . .	64
4.3	The Even-Parity $\Delta^{++}$ . . . . .	66
4.3.1	Correlation Functions . . . . .	66
4.3.2	Effective Mass Plots . . . . .	68
4.4	The Odd-Parity $\Delta^{++}$ . . . . .	70
4.4.1	Correlation Functions . . . . .	70
4.4.2	Effective Mass Plots . . . . .	72
4.5	The Odd-parity $\Lambda$ . . . . .	74
4.5.1	Correlation Functions . . . . .	74
4.5.2	Effective Mass Plots . . . . .	77
<b>5</b>	<b>Conclusion</b>	<b>81</b>
<b>A</b>	<b>The Gell-Mann Matrices</b>	<b>83</b>
<b>B</b>	<b><math>\gamma</math>-Matrices</b>	<b>85</b>
B.1	Dirac Representation . . . . .	85
B.2	Pauli Representation . . . . .	87
<b>C</b>	<b>Clebsch-Gordan Coefficients</b>	<b>89</b>
<b>D</b>	<b>Wick's Theorem</b>	<b>91</b>
<b>E</b>	<b>Transformation Properties of Interpolating Fields</b>	<b>95</b>
E.1	Lorentz Transformations . . . . .	96
E.1.1	Meson Interpolators . . . . .	96
E.1.2	Baryon Interpolators . . . . .	96
E.1.3	Two-Particle Interpolators . . . . .	98
E.2	Parity . . . . .	98

<b>F Correlation Functions</b>	<b>101</b>
F.1 Two-Particle Proton Correlation Function . . . . .	101
F.2 Two-Particle $\Lambda$ Correlation Function . . . . .	109
F.3 Two-Particle $\Delta^{++}$ Correlation Function . . . . .	145
F.4 Equivalence of Correlation Functions . . . . .	146
<b>Bibliography</b>	<b>151</b>



# List of Figures

1.1	The spectrum of two non-interacting particles (with the $1/L$ behaviour) is on the left. The resonance energy is shown by the flat line at 1.4. The right diagram depicts the ALC near the resonance energy. Figure from [19]. . . . .	3
1.2	The masses of the odd-parity, $J^P = 1/2^-$ , states of the $\Lambda$ baryon. The correlation matrix analysis allows the isolation of the three lowest lying states. Figure courtesy of B. Menadue [9]. . . . .	4
1.3	Masses of the positive parity states of the nucleon at various quark masses. The lattice results for the Roper are the red triangles. The black data points to the far left are the physical values obtained from [22]. Figure courtesy of S. Mahbub [21]. . . . .	4
2.1	The smallest possible closed loop on the lattice, the plaquette $U_{\mu\nu}(n)$ .	25
2.2	The terms that contribute to the clover $C_{\mu\nu}(n)$ . . . . .	27
3.1	The “fully-connected” (left) and “loop-containing” (right) contributions to the two-point functions given in section (3.3) for the five quark operators in section (3.2). Note the four “types” of propagators we require to evaluate such diagrams. . . . .	45
3.2	An effective mass plot for the pion using the stochastically estimated $S(x, 0)$ in the pion correlation function. . . . .	52
3.3	An effective mass plot for the pion using the standard point-to-all propagator $S(x, 0)$ in the pion correlation function. . . . .	53
4.1	Correlation function plots for the three-quark nucleon operator with zero momentum and one unit of momentum. . . . .	56

4.2	Correlation function plots for the pion and five-quark proton operator. We can observe that the correlator for the five-quark proton operator is very similar to the correlator obtained for the standard three-quark nucleon shown in Figure 4.1 (b). . . . .	57
4.3	The correlation function plots for the loop-containing and fully-connected pieces of the five-quark proton operator. We observe that the loop-containing piece of the five-quark proton operator in (a) is virtually indistinguishable from the total five-quark operator correlation function in Figure 4.2 (b), indicating that this piece is the dominant contribution. . . . .	57
4.4	A comparison of the loop-containing and fully-connected pieces of the five-quark proton operator correlation function. Here we observe the fully-connected piece has a greater slope indicating this piece is associated with more massive contributions. . . . .	58
4.5	Effective Mass plots for the nucleon and pion with one unit of momentum each. . . . .	59
4.6	An effective mass plot for the standard three-quark nucleon operator at zero momentum. . . . .	59
4.7	A mass plot for the five-quark proton operator compared to the extracted three-quark nucleon result at zero momentum shown in Figure 4.6. . . . .	60
4.8	A comparison of the effective mass plots for the fully-connected and loop-containing pieces. Recall that the total correlation function is almost entirely dominated by the disconnected piece, and as such they are virtually indistinguishable. . . . .	60
4.9	Correlation function plots for the three-quark and five-quark proton interpolators. . . . .	62
4.10	Correlation function plots for the loop-containing and fully-connected pieces of the five-quark proton interpolator. . . . .	62
4.11	A comparison of the loop-containing and fully-connected pieces of the five-quark proton correlation functions. . . . .	63
4.12	Effective Mass plots for the three-quark proton operator and the pion at $\vec{p} = 0$ . . . . .	64
4.13	An effective mass plot for the five-quark proton operator. . . . .	64
4.14	An effective mass plot comparing the loop-containing and fully-connected pieces of the five-quark proton. . . . .	65
4.15	A correlation function plot for the five-quark $\Delta^{++}$ interpolator. . . . .	66



4.16	Correlation function plots for the loop-containing and fully-connected pieces of the five-quark $\Delta^{++}$ . . . . .	66
4.17	A comparison of the loop-containing and fully-connected pieces of the five-quark $\Delta^{++}$ correlation functions. . . . .	67
4.18	An effective mass plot for the five-quark $\Delta^{++}$ operator. . . . .	68
4.19	An effective mass plot comparing the loop-containing and fully-connected pieces of the five-quark $\Delta^{++}$ . . . . .	68
4.20	A correlation function plot for the five-quark $\Delta^{++}$ interpolator. . . . .	70
4.21	Correlation function plots for the loop-containing and fully-connected pieces of the five-quark $\Delta^{++}$ . . . . .	70
4.22	A comparison of the loop-containing and fully-connected pieces of the five-quark $\Delta^{++}$ correlation functions. . . . .	71
4.23	An effective mass plot for the five-quark $\Delta^{++}$ operator. . . . .	72
4.24	An effective mass plot comparing the loop-containing and fully-connected pieces of the five-quark $\Delta^{++}$ . . . . .	72
4.25	Effective mass plots for the flavour-singlet and “common” three-quark $\Lambda$ interpolators. . . . .	74
4.26	Correlation function plots of the three-quark octet interpolator and five-quark operator for the $\Lambda$ . . . . .	75
4.27	Plots of the loop-containing and fully-connected pieces for the five-quark operator $\Lambda$ . . . . .	75
4.28	A comparison of the fully-connected and loop-containing pieces of the five-quark $\Lambda$ interpolator. As was the case with the proton and $\Delta^{++}$ , we observe the fully-connected piece possessing a steeper slope and therefore is associated with more massive parts of the spectrum. . . . .	76
4.29	Effective Mass plots for various three-quark $\Lambda$ interpolators. . . . .	77
4.30	An effective mass plot for the five-quark $\Lambda$ interpolator. . . . .	78
4.31	A comparison of the fully-connected and loop-containing pieces of the five-quark $\Lambda$ interpolator. The nucleon mass is presented in Section 4.1. (Recall that as we are at the $SU(3)$ flavour limit the kaon is identical to the pion - see Appendix F.) . . . . .	78
C.1	<i>Clebsch-Gordan coefficients for the case <math>I' = 1/2, I'' = 1/2</math>.</i> Recall there is an implicit square root sign over the positive part of each table entry. . . . .	89

- C.2 *Clebsch-Gordan coefficients for the case  $I' = 1, I'' = 1/2$ .* Recall there is an implicit square root sign over the positive part of each table entry. 90

# List of Tables

3.1	The classification of the various particles relevant to this work and their corresponding interpolating fields. . . . .	39
3.2	The values of various traces for the stochastically estimated propagator with full spin, colour and time dilution. The average is taken over all space-time points and gauge configurations. One noise vector has been used. . . . .	49
3.3	The values of various traces for the stochastically estimated propagator with full spin and colour dilution and interleaved 4-time dilution. The average is taken over all space-time points and gauge configurations. One noise vector has been used. . . . .	49
3.4	The values of various traces for the standard point-to-all propagator, with the “all” $x$ set to the “point value”, to make a loop. The average is taken over gauge configurations. . . . .	50
3.5	The values of various traces for the stochastically estimated propagator with full spin and colour dilution and interleaved 4-time dilution. Two noise vectors are averaged over in addition to the averaging over all space-time points and gauge configurations. . . . .	51
3.6	The values of various traces for the stochastically estimated propagator with full spin, colour and time dilution. Two noise vectors are averaged over in addition to the averaging over all space-time points and gauge configurations. . . . .	51



# Abstract

Quantum Chromodynamics (QCD) is widely accepted as the theory that describes the strongest force in Nature (by coupling constant), aptly named the strong nuclear force. The challenge is to understand the phenomena that emerge from this fundamental quantum field theory. Hadronic spectroscopic calculations can be performed utilising the formalism of lattice QCD by discretising space-time onto a hypercube. This is the only known non-perturbative *ab-initio* approach for studying QCD. Equipped with a tractable formalism, we consider some recent work done extracting resonances, in particular the Roper and the  $\Lambda(1405)$  resonances studied at the CSSM in Adelaide. These studies are done with three quark interpolators, and as such we expect to be extracting resonances having strong overlap three-quark states. In order to rule out the possibility of contamination from more exotic five-quark states, and to extract multi-particle states in their own right, the use of five-quark interpolators is of considerable interest. We first construct five-quark interpolating fields for the  $p$ ,  $\Lambda$  and  $\Delta^{++}$ . The corresponding correlation functions are calculated which can be of considerable size. Relevant elements of the all-to-all propagator (the so-called loop propagator), are calculated using stochastic estimation techniques. Dilution in spin, colour and time are implemented as a means of variance reduction. We conclude by presenting effective mass plots for the five-quark interpolators, the relevant contributions from fully connected and loop containing pieces, and comparing them to the masses extracted from standard three-quark operators.



# Declaration

This work contains no material which has been accepted for the award of any other degree or diploma in any university or other tertiary institution to Adrian Leigh Kiratidis and, to the best of my knowledge and belief, contains no material previously published or written by another person, except where due reference has been made in the text.

I give consent to this copy of my thesis, when deposited in the University Library, being made available for loan and photocopying, subject to the provisions of the Copyright Act 1968.

I also give permission for the digital version of my thesis to be made available on the web, via the University's digital research repository, the Library catalogue, the Australasian Digital Theses Program (ADTP) and also through web search engines, unless permission has been granted by the University to restrict access for a period of time.

Adrian Leigh Kiratidis





# Acknowledgements

First and foremost, I'd like to thank my supervisors Derek Leinweber and Waseem Kamleh for their exceptional guidance, encouragement and patience throughout the last two years of my M.Phil. During this time they have constantly made time for me in their busy schedules, and have always provided clear explanations. Without them none of this would have been possible, so to that end I owe them greatly.

The Adelaide CSSM lattice collaboration's cola and genf were used extensively in this research, and I'd therefore like to acknowledge the authors Waseem Kamleh and Peter Moran.

To the guys in the office over the past two years, Daniel, Ben O., Nathan, Sam, Ben M., Phiala and Sophie, thanks for all the informative and thought provoking discussions, both on physics and non-physics related topics. They were of great help both aiding my physics understanding and making the journey enjoyable. In particular, I owe a special thanks to Daniel and Ben O. for the many useful algorithm discussions. The M.Phil experience has also given me the opportunity to discuss with many other great people, Dale, Selim, Ross, James, Lewis, Manuel and Mariusz, just to name a few.

Finally I'd like to thank my family and friends for their support, encouragement and understanding. In particular I owe a special thanks to my parents who not only have listened to my desperate "preserving the universe's order" arguments with respect to the state of my room and tolerated my occasionally nocturnal inclinations, but have also taken essentially all financial and logistical issues out of my life for which I am greatly thankful.



# Chapter 1

## Introduction

Physics in general and quantum theory in particular has impacted our modern lives significantly. With the “quantum hypothesis” of Planck in 1900 and the subsequent development of quantum mechanics in the 1920’s came the necessary knowledge to study semi-conductors. A few decades later, the transistor, a fundamental constituent of modern electronics was developed. One would surely be hard pressed to think of a more influential technology than the digital computer chip. Other technologies such as global communication, the laser, electron microscopes and even USB flash drives, just to name a few, owe their existence - in part - to developments in quantum mechanics.

Since the 1920’s, remarkable progress has been made. Quantum Electrodynamics (QED) - with its apt acronym - was developed through the middle part of the 20th century, making experimental predictions with unprecedented precision, consequently prompting Feynman to refer to it as the “Jewel of Physics”. The first non-Abelian gauge theory was constructed by Yang and Mills in 1954, Gellmann and Zweig proposed their quark model in 1963, and the demonstration that Yang-Mills Theory was renormalisable (given symmetry breaking assumptions) was made by t’Hooft and Veltman in 1971. By this time quantum theory was truly coming of age, perhaps emphasized in the mid 1970’s by the unification of three of the four fundamental forces as a relativistic Quantum Field Theory (QFT), known as the Standard Model (SM).

The three forces described by the SM, that is the strong and weak nuclear interactions and the electromagnetic interaction, are mediated by gauge bosons. The strongest of these forces (by coupling constant), aptly named the strong nuclear force is responsible for the interaction between the quarks and gluons making up the hadrons, and is governed by the non-Abelian gauge theory, Quan-

tum Chromodynamics (QCD).

As the QCD gauge group of  $SU(3)$  is non-Abelian, the gauge boson of QCD - the gluon - in addition to mediating the force between colour charged quarks, carries colour charge itself giving rise to self interactions. These self interactions give rise to the non-trivial QCD vacuum, colour confinement and dynamical mass generation. This dynamically generated mass is responsible for approximately 97% of the nucleon mass.

Due to this added non-perturbative complexity which is not present in Abelian Quantum Electrodynamics (QED), traditional perturbative techniques lead to analytic intractability in the low energy regime. Thus, in order to study low energy QCD we must either resort to continuum phenomenological arguments that are non-*ab-initio*, or employ the formalism of Lattice QCD, which is not continuum based but is *ab-initio*. Fortunately in 1974, Wilson developed a method for quantising a gauge theory onto a hypercube [1]. By discretising space-time onto this hypercube physicists were able to perform Monte Carlo simulations in the low energy region of QCD on massively parallel supercomputers, signaling the birth of Lattice QCD. QCD's property of asymptotic freedom then enables a connection back to continuum physics via perturbation theory.

In this work we use the formalism of lattice QCD to study multi-particle baryon spectroscopy. We therefore begin with a brief motivation outlining the relevance of such a study, followed by a discussion of the continuum theory we aim to simulate.

## 1.1 Motivation

In Nature a significant number of particles are resonances. Consequently, there has been substantial interest in studying the excited baryon spectrum both experimentally in places such as Jefferson Lab [2], and using lattice QCD [3–15]. Resonances cannot be associated with a single energy level of the Hamiltonian as in the stable particle case, and so considerably more effort is required to determine their mass and width.

A standard approach proposed by Lüscher [16–18] begins by considering the multi-particle finite volume energy spectrum. By virtue of the discretisation of space-time onto a finite lattice with spacing  $a$ , we necessarily quantise momentum as

$$p_x = \frac{2\pi}{aN_x}n \tag{1.1}$$

where

$$-\frac{N_x}{2} < n \leq \frac{N_x}{2}, \quad (1.2)$$

$N_x$  is the number of lattice points in the  $x$  direction, and of course

$$L_x = aN_x \quad (1.3)$$

is the extent of the lattice box in the  $x$  direction. The total energy  $E$  of two particles 1 and 2 in a finite volume box with zero total momentum is then given by

$$E = \sqrt{m_1^2 + |\vec{p}|^2} + \sqrt{m_2^2 + |\vec{p}|^2} \quad (1.4)$$

where  $\vec{p}$  is the momentum for each particle<sup>1</sup>. We then immediately see upon substituting (1.1) into (1.4), that the energy has a  $1/L$  dependence due to the momentum quantisation. This can be seen in the left diagram of Figure 1.1. Successive curves going as  $1/L$  are shown, which correspond to the various momenta of the states. For example, the lowest energy curve corresponds to the smallest possible two-particle momentum.

However, (1.1) is valid for non-interacting particles, but when the interaction is turned on this is replaced with a Lüscher formula [19]. This has the effect of rearranging the energy levels near the resonance energy as seen in the right plot of Figure 1.1, which is called an avoided level crossing (ALC). This somewhat unusual behaviour is the signal of the presence of a resonance.

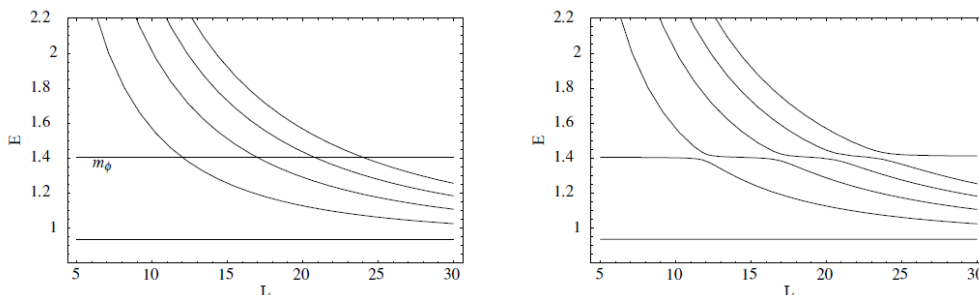

Figure 1.1: The spectrum of two non-interacting particles (with the  $1/L$  behaviour) is on the left. The resonance energy is shown by the flat line at 1.4. The right diagram depicts the ALC near the resonance energy. Figure from [19].

Recently, the CSSM lattice collaboration has been studying the  $\Lambda(1405)$ [9, 20] and Roper [12–14, 21] resonances with conventional three quark interpolators via correlation matrix techniques. Results are presented in Figures 1.2 and 1.3.

<sup>1</sup>We note this approximation does not take into account discretisation artefacts.

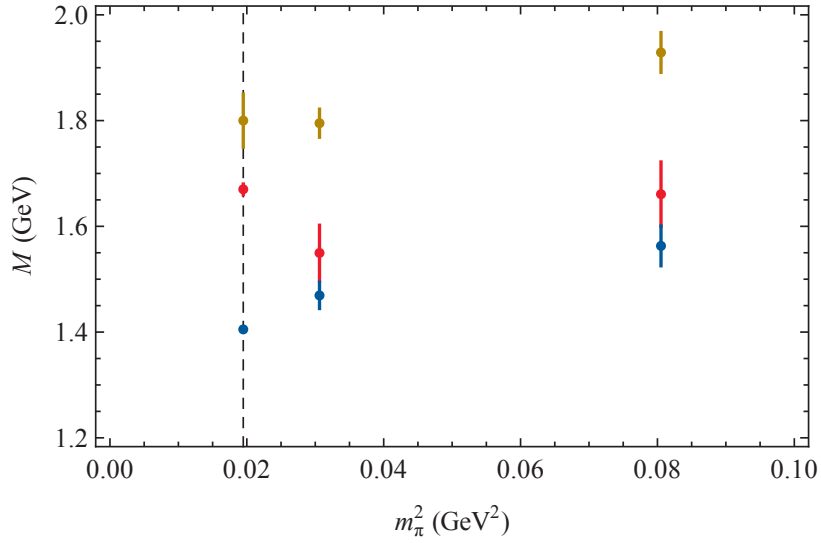

Figure 1.2: The masses of the odd-parity,  $J^P = 1/2^-$ , states of the  $\Lambda$  baryon. The correlation matrix analysis allows the isolation of the three lowest lying states. Figure courtesy of B. Menadue [9].

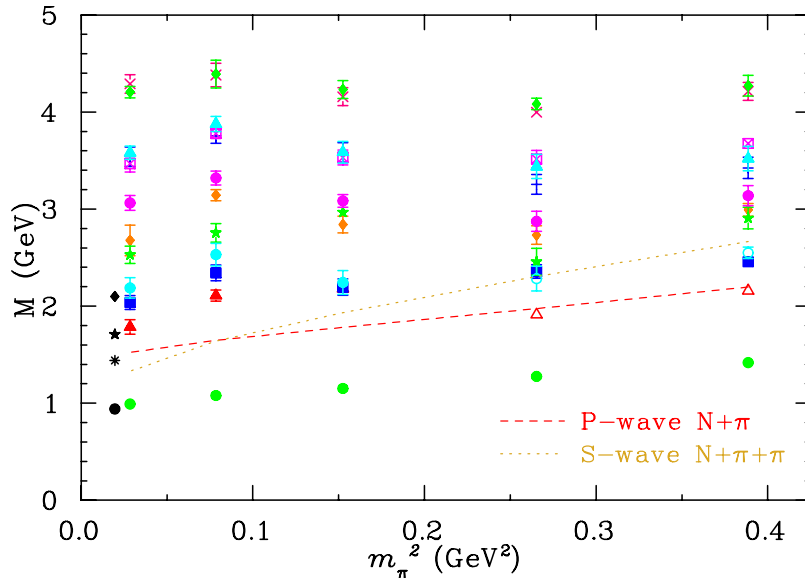

Figure 1.3: Masses of the positive parity states of the nucleon at various quark masses. The lattice results for the Roper are the red triangles. The black data points to the far left are the physical values obtained from [22]. Figure courtesy of S. Mahbub [21].

Although the trend of the lowest lying state reproduces the correct physical mass for the anomalously low  $\Lambda(1405)$ , we can't be absolutely certain of the true

nature of this state. That is, whether the extracted states are best described by a conventional three-quark baryon or a more exotic kaon-nucleon (for the  $\Lambda$ ) or pion-nucleon (for the Roper) state. It is for this reason that multi-particle interpolators are important, as owing to their higher overlap with more exotic five-quark states, they will be able to resolve the resonances and extract a multi-particle state. This is essential for a complete understanding of the Roper resonance for example.

We therefore aim to construct these five-quark interpolators and perform spectroscopic calculations with them. Before doing so however, we review QCD and the method employed for discretising it onto a lattice hypercube.

## 1.2 Continuum QCD

The dynamics of strongly interacting particles are governed by the QCD Lagrangian density<sup>2</sup>

$$\mathcal{L}_{QCD} = \sum_{i=1}^{N_f} \bar{\psi}_i(x) (i\gamma^\mu D_\mu - m_i) \psi_i(x) - \frac{1}{2} \text{Tr}(F_{\mu\nu} F^{\mu\nu}), \quad (1.5)$$

where we have suppressed colour and Dirac indices. Here  $\psi_i(x)$  is a Dirac 4-spinor representing the fermion field with flavour  $i$ ,  $N_f$  is the number of flavours,  $\gamma^\mu$  are the Dirac  $\gamma$ -matrices,  $D_\mu$  is the covariant derivative

$$D_\mu = \partial_\mu + igA_\mu, \quad (1.6)$$

and  $F_{\mu\nu}$  is the field strength tensor given by

$$F_{\mu\nu}(x) = \sum_a \frac{\lambda^a}{2} F_{\mu\nu}^a(x), \quad (1.7)$$

where

$$F_{\mu\nu}^a = \partial_\mu A_\nu^a - \partial_\nu A_\mu^a - gf^{abc} A_\mu^b A_\nu^c. \quad (1.8)$$

The field strength tensor can also be written as a commutator of covariant derivatives

$$igF_{\mu\nu} = [D_\mu, D_\nu]. \quad (1.9)$$

The  $\lambda^a$  are the generators of the gauge group  $SU(3)$ ,  $f^{abc}$  are the structure constants, and  $A_\mu$  is the gluon field which are proportional to the generators of

---

<sup>2</sup>Excellent introductory discussions can be found in [23–26].

$SU(3)$

$$A_\mu(x) = \sum_a \frac{\lambda^a}{2} A_\mu^a(x). \quad (1.10)$$

The group generators are a basis for traceless Hermitian  $3 \times 3$  matrices satisfying

$$\text{Tr}[\lambda^a \lambda^b] = \delta^{ab} \quad \text{and} \quad \left[ \frac{\lambda^a}{2}, \frac{\lambda^b}{2} \right] = i f^{abc} \lambda^c. \quad (1.11)$$

For our lattice simulation it is often useful to consider the action. The QCD action  $S_{QCD}$  is given by taking the space-time integral of the Lagrangian density (1.5)

$$\begin{aligned} S_{QCD} &= \int d^4x \mathcal{L}_{QCD} \\ &= \int d^4x \bar{\psi}(x) (i\gamma^\mu D_\mu - m) \psi(x) - \frac{1}{2} \int d^4x \text{Tr}(F_{\mu\nu} F^{\mu\nu}) \\ &= S_F + S_G, \end{aligned} \quad (1.12)$$

where we have suppressed the sum over the flavour indices and  $S_F$  and  $S_G$  are the fermionic and gauge actions (in Minkowski space) respectively. However, actions in Euclidean space are necessary to perform lattice simulations. We therefore perform the transformations  $x^0 \rightarrow -ix_4$  and  $A^0 \rightarrow +iA_4$ , which gives us the transformation property [26]

$$iS^{\text{Min.}} \rightarrow -S^{\text{Eucl.}}. \quad (1.13)$$

Our Euclidean action is therefore given by

$$\begin{aligned} S_{QCD}^{\text{Eucl.}} &= \int d^4x \bar{\psi}(x) (\gamma^\mu D_\mu + m) \psi(x) + \frac{1}{2} \int d^4x \text{Tr}(F_{\mu\nu} F^{\mu\nu}) \\ &= S_F^{\text{Eucl.}} + S_G^{\text{Eucl.}}. \end{aligned} \quad (1.14)$$

Having written down our action we should verify that it gives the fermions the correct dynamics, that is, that we can recover the relativistic wave equation for fermions, the Dirac equation. Differentiating the integrand of  $S_F^3$  with respect to  $\bar{\psi}$  and substituting into the Euler-Lagrange equations, we obtain

$$(\gamma^\mu D_\mu + m)\psi(x) = 0, \quad (1.15)$$

which is indeed the Dirac equation (in Euclidean space), as required. The action (and the Lagrangian) must also necessarily be invariant under a change of physically irrelevant gauge.

---

<sup>3</sup>From here on the Eucl. superscript will be taken to the implicit unless otherwise stated.



## 1.3 Gauge Invariance

Physically, it is clear that under global gauge transformations our action must be invariant. We can readily see for example that the fermion action is invariant under the transformations

$$\psi(x) \rightarrow \psi'(x) = \Omega\psi(x), \quad \bar{\psi}(x) \rightarrow \bar{\psi}'(x) = \bar{\psi}(x)\Omega^\dagger, \quad (1.16)$$

owing to the unitarity of  $\Omega$  (as  $\Omega \in SU(3)$ ). However, the principle of gauge invariance requires us to have an action that is also invariant under the local transformations

$$\psi(x) \rightarrow \psi'(x) = \Omega(x)\psi(x), \quad \bar{\psi}(x) \rightarrow \bar{\psi}'(x) = \bar{\psi}(x)\Omega^\dagger(x), \quad (1.17)$$

where here  $\Omega(x) \in SU(3)$  represents an independent  $SU(3)$  matrix at each space-time point. We start by considering the fermionic part of the action.

### 1.3.1 Fermion Action

Invariance of the fermion action  $S_F$  under the local transformations (1.17), means

$$S_F \equiv S_F[\psi, \bar{\psi}, A] = S_F[\psi', \bar{\psi}', A'] \equiv S'_F \quad (1.18)$$

where the prime refers to the transformed objects as usual. Applying our transformations (1.17) to the fermion action (1.14), and enforcing (1.18) we obtain

$$\begin{aligned} S'_F &= \int d^4x \bar{\psi}'(x) (\gamma^\mu (\partial_\mu + igA'_\mu) + m) \psi'(x) \\ &= \int d^4x \bar{\psi}(x) \Omega(x)^\dagger (\gamma^\mu (\partial_\mu + igA'_\mu) + m) \Omega(x) \psi(x) \\ &= \int d^4x \bar{\psi}(x) (\gamma^\mu (\partial_\mu + igA_\mu) + m) \psi(x). \end{aligned} \quad (1.19)$$

Then noting  $\Omega$  is unitary, we can see that in order to ensure gauge invariance we must have

$$\begin{aligned} \bar{\psi}(x) (\partial_\mu + igA_\mu(x)) \psi(x) &= \bar{\psi}(x) \Omega^\dagger(x) (\partial_\mu + igA'_\mu(x)) \Omega(x) \psi(x) \\ &= \bar{\psi}(x) \Omega^\dagger(x) (\partial_\mu \Omega(x)) \psi \\ &\quad + \bar{\psi}(x) (\Omega^\dagger(x) \Omega(x)) \partial_\mu \psi \\ &\quad + \bar{\psi}(x) \Omega^\dagger(x) igA'_\mu(x) \Omega(x) \psi \\ &= \bar{\psi}(x) (\partial_\mu + \Omega^\dagger(x) (\partial_\mu \Omega(x)) + ig\Omega^\dagger(x) A'_\mu(x) \Omega(x)) \psi \\ \Rightarrow \partial_\mu + igA_\mu(x) &= \partial_\mu + \Omega^\dagger(x) (\partial_\mu \Omega(x)) + ig\Omega^\dagger(x) A'_\mu(x) \Omega(x). \end{aligned} \quad (1.20)$$

Solving for  $A'_\mu(x)$  then enables us to write down the transformation property of the gauge field

$$A_\mu(x) \rightarrow A'_\mu(x) = \Omega(x)A_\mu(x)\Omega^\dagger(x) + \frac{i}{g}(\partial_\mu\Omega(x))\Omega^\dagger(x). \quad (1.21)$$

This transformation property is a necessary consequence of demanding the invariance of the fermion action under local gauge transformations.

### 1.3.2 Gauge Action

Demonstrating the required gauge invariance of our action

$$S_G[A] = S_G[A'] \quad (1.22)$$

is straightforward. We begin by obtaining the transformation condition for the covariant derivative

$$D_\mu(x) \rightarrow D'_\mu(x) = \partial_\mu + igA'_\mu(x) = \Omega(x)D_\mu(x)\Omega^\dagger(x) \quad (1.23)$$

from (1.20). Then using Equations (1.9) and (1.23) we obtain the transformation condition for the field strength tensor,

$$F_{\mu\nu}(x) \rightarrow F'_{\mu\nu} = \Omega(x)F_{\mu\nu}\Omega^\dagger(x). \quad (1.24)$$

Our gauge action

$$S_G[A] = \frac{1}{2} \int d^4x \text{Tr}(F_{\mu\nu}F^{\mu\nu}) = \frac{1}{4} \int d^4x \text{Tr}(F_{\mu\nu}^a F_{\mu\nu}^a), \quad (1.25)$$

(from (1.14)) is therefore gauge invariant given the transformation property of  $F_{\mu\nu}$  (as  $\Omega(x)$  is unitary and the trace is invariant under cyclic permutations). It is instructive to note the similarities of our QCD action to that of electrodynamics. Our QCD action is a sum over colour components, (indexed by  $a$  in Equation (1.25)) each term of which has the familiar form of the QED action. The qualitative difference between terms occurs in the non-linearity of the colour components of the field strength tensor. Inspecting Equation (1.8), we see the first two terms of  $F_{\mu\nu}$  are linear in the gauge field just like QED, but the third term is quadratic in the gauge field. When inserting our aforementioned expression for  $F_{\mu\nu}$  into (1.25), we therefore obtain cubic and quartic terms in addition to the familiar quadratic terms from QED. It is these cubic and quartic terms that allow three and four gluon vertex Feynman diagrams, giving rise to self interactions of the gluon, and ultimately the most prominent feature of QCD, colour confinement.

## 1.4 The Path-Integral Formalism

In field theory, the information about the physics of the system is stored in a set of vacuum expectation values of time ordered products of field operators, the correlation functions or Green's functions. The standard approach to quantise a field theory is via the path-integral (PI) formalism, where the PI representation of the correlation functions is built on integrals over anti-commuting Grassmann variables. We begin by introducing some of the properties of these Grassmann variables and make use of them to write down a PI representation of the inverse of the Dirac operator. We will see in Chapter 3 that calculating this inverse is crucial to this work. We then proceed to discretise the actions introduced in Chapter 1, discussing improvements to the naive discretisation scheme. This discussion closely follows that given in [26].

### 1.4.1 Calculus with Grassmann Variables

A set  $\eta_1, \eta_2, \dots, \eta_N$  are generators of a Grassmann algebra if they anti-commute. That is,

$$\{\eta_i, \eta_j\} = \eta_i\eta_j + \eta_j\eta_i = 0 \quad i, j = 1 \dots N. \quad (1.26)$$

In general, some arbitrary element of a Grassmann algebra can be Taylor expanded in  $\eta_i$ ,

$$f(\eta) = f_0 + \sum_i f_i \eta_i + \sum_{i,j} f_{ij} \eta_i \eta_j + \dots + f_{1\dots N} \eta_1 \dots \eta_N, \quad (1.27)$$

which obviously terminates after a finite number of terms, as is it clear from (1.26) that

$$\eta_i^2 = 0 \quad \forall i = 1, \dots, N. \quad (1.28)$$

### Integration

Integration will be the main thing we wish to do with Grassmann numbers. In order to do functional integration we need not define definite integrals explicitly, only integrals over all values of the variable. Momentarily restricting ourselves to integrals over one variable, we can see as a consequence of (1.28) that

$$\int d\eta f(\eta) = \int d\eta (C_1 + C_2\eta) \quad (1.29)$$

where  $C_1$  and  $C_2$  are constants. We also require our integral to be invariant under the shift of integration variable  $\eta$  by a constant  $\eta_c$ . That is,

$$\int d\eta(C_1 + C_2\eta) = \int d\eta((C_1 + C_2\eta_c) + C_2\eta). \quad (1.30)$$

We can see that a solution to this condition can be found by defining, as in [27]

$$\int d\eta(C_1 + C_2\eta) = C_2. \quad (1.31)$$

The rules

$$\begin{aligned} \int d\eta_i &= 0 \\ \int d\eta_i \eta_i &= 1 \end{aligned} \quad (1.32)$$

are therefore sufficient to evaluate an arbitrary integral of the form

$$\int \prod_{i=1}^N d\eta_i f(\eta), \quad (1.33)$$

where  $f(\eta)$  takes the most general form given in (1.27). It is also important to note when evaluating multiple integrals, that the integration measures anti-commute with both themselves and the variables. That is to say,

$$\{d\eta_i, d\eta_j\} = 0 = \{d\eta_i, \eta_j\} \quad \forall i, j = 1, \dots, N. \quad (1.34)$$

We can now apply these rules to calculate integrals. One such useful integral, sometimes referred to as the *Mathews-Salam Formula*, is given by<sup>4</sup>,

$$\int \mathcal{D}(\bar{\eta}\eta) \exp(-\bar{\eta}A\eta) = \det A, \quad (1.35)$$

where

$$\mathcal{D}(\bar{\eta}\eta) = \prod_{i=1}^N d\bar{\eta}_i d\eta_i. \quad (1.36)$$

## Differentiation

The rules for differentiation of a general  $f(\eta)$  with respect to a Grassmann variable  $\eta_i$  are given by:

- If  $f(\eta)$  is independent of  $\eta_i$ , then  $\frac{\partial}{\partial \eta_i} f(\eta) = 0$ .

---

<sup>4</sup>For a derivation see for example [28] and [29].

- If  $f(\eta)$  is dependent on  $\eta_i$ , then the left derivative  $\frac{\partial}{\partial\eta_i}$  is calculated by anti-commuting  $\eta_i$  all the way to the derivative on the left, and then applying

$$\frac{\partial}{\partial\eta_i}\eta_i = 1. \quad (1.37)$$

- Similarly, the right derivative  $\overleftarrow{\frac{\partial}{\partial\eta_i}}$  is calculated by anti-commuting  $\eta_i$  all the way to the derivative on the right, and applying

$$\eta_i\overleftarrow{\frac{\partial}{\partial\eta_i}} = 1. \quad (1.38)$$

It is then clear from these differentiation rules together with the integration rules of (1.32) that the properties

$$\int d\eta_i f(\eta) = \frac{\partial}{\partial\eta_i} f(\eta), \quad (1.39)$$

and

$$\left\{ \frac{\partial}{\partial\eta_i}, \frac{\partial}{\partial\eta_j} \right\} = 0, \quad (1.40)$$

hold for Grassman variables.

These properties can then be used to show<sup>5</sup> that

$$\int \mathcal{D}(\bar{\eta}\eta)\eta\bar{\eta} \exp(-\bar{\eta}A\eta) = (\det A)A^{-1}, \quad (1.41)$$

which together with (1.35) will be used shortly.

## 1.4.2 The Path Integral

We begin our discussion of the path integral formalism by introducing the generating functional in Euclidean space given by

$$\mathcal{Z} = \int \mathcal{D}\psi\mathcal{D}\bar{\psi} e^{-S^{\text{Eucl.}}[\psi,\bar{\psi},A]}, \quad (1.42)$$

where the integration measure  $\mathcal{D}\phi$  for a field  $\phi$  roughly represents an integral over all possible field values at all points in space-time<sup>6</sup>. Here,  $\psi$  and  $\bar{\psi}$  are Grassmann variables representing the fermion fields and  $S^{\text{Eucl.}}[\psi,\bar{\psi},A]$  is the Euclidean action

<sup>5</sup>See [26] for a full derivation.

<sup>6</sup>A more detailed discussion of functional integration can be found in [26].

given in (1.14). In the presence of fermion source fields  $\eta$  and  $\bar{\eta}$  the generating functional is then given by

$$\mathcal{Z}[\eta, \bar{\eta}] = \int \mathcal{D}\psi \mathcal{D}\bar{\psi} e^{\int d^4x (-\mathcal{L}(x) + \bar{\eta}(x)\psi(x) + \eta(x)\bar{\psi}(x))}. \quad (1.43)$$

In order to calculate  $n$ -point functions we take derivatives with respect to  $\eta$  and  $\bar{\eta}$ , and set the source fields to zero in order to get the relevant terms. For example, the 2-point correlation function from  $x$  to  $y$  which is the fermion propagator, is given by

$$\langle \Omega | T \psi(y) \bar{\psi}(x) | \Omega \rangle = \frac{1}{\mathcal{Z}_0} \left( \frac{\delta}{\delta \bar{\eta}(y)} \right) \left( - \frac{\delta}{\delta \eta(x)} \right) \mathcal{Z}[\eta, \bar{\eta}] \Big|_{\eta, \bar{\eta}=0}, \quad (1.44)$$

where

$$\mathcal{Z}_0 = \int \mathcal{D}\psi \mathcal{D}\bar{\psi} e^{-\int d^4x \mathcal{L}(x)}. \quad (1.45)$$

In order to evaluate this, we invoke the definition of the functional derivative  $\frac{\delta F[\psi]}{\delta \psi}$  of  $F[\psi]$  with respect to  $\psi$ , which is given by

$$\int d^4x \phi(x) \frac{\delta F}{\delta \psi} := \lim_{\epsilon \rightarrow 0} \frac{F[\psi + \epsilon \phi] - F[\psi]}{\epsilon} = \frac{d}{d\epsilon} F[\psi + \epsilon \phi] \Big|_{\epsilon=0}, \quad (1.46)$$

where  $\phi$  is some smooth test function. In evaluating (1.44) we see functionals of the form  $F_1[\psi] = e^{\int d^4x \psi(x) \rho(x)}$ , which can be easily calculated using (1.46) obtaining

$$\frac{\delta F_1[\psi]}{\delta \psi} = \rho(x) F_1[\psi]. \quad (1.47)$$

Using (1.47) we can then evaluate (1.44) obtaining

$$\langle \Omega | T \psi(y) \bar{\psi}(x) | \Omega \rangle = \frac{\int \mathcal{D}(\bar{\psi}\psi) \psi \bar{\psi} \exp(-\bar{\psi} M \psi)}{\int \mathcal{D}(\bar{\psi}\psi) \exp(-\bar{\psi} M \psi)}, \quad (1.48)$$

where  $M = (\gamma^\mu D_\mu + m)$  is the fermion matrix. Then using the values of these integrals that we have seen in (1.41) and (1.35), we can see

$$\langle \Omega | T \psi(y) \bar{\psi}(x) | \Omega \rangle = M^{-1}(y, x). \quad (1.49)$$

That is, the fermion propagator is given by the inverse of the fermion matrix. We further discuss the calculation of propagators on the lattice in Section 3.4.

### Expectation Values

We can now apply the path integral formalism to calculate vacuum expectation values of operators, and hence observables. Observables in QCD are given by [30]

$$\langle \mathcal{O} \rangle = \frac{1}{\mathcal{Z}} \int \mathcal{D}\psi \mathcal{D}\bar{\psi} \mathcal{D}A \mathcal{O}[\psi, \bar{\psi}, A] e^{-S^{\text{Eucl.}}[\psi, \bar{\psi}, A]}, \quad (1.50)$$

where

$$\mathcal{Z} = \int \mathcal{D}\psi \mathcal{D}\bar{\psi} \mathcal{D}A e^{-S^{\text{Eucl.}}[\psi, \bar{\psi}, A]}. \quad (1.51)$$

(1.50) can then be evaluated using Grassmann algebra giving [26]

$$\langle \mathcal{O} \rangle = \frac{1}{\mathcal{Z}} \int \mathcal{D}A \mathcal{O}(M^{-1}, A) \det(M) e^{-\frac{1}{2} \int d^4x \text{Tr}(F_{\mu\nu} F_{\mu\nu})}. \quad (1.52)$$

We note that the operator  $\mathcal{O}$  is dependent on the inverse of the fermion matrix, and the gauge field. The determinant encodes the role of the quark loops present in the vacuum, and is very computationally expensive. Earlier lattice simulations (for example [31–33]) set this value to a constant, effectively turning off sea quark loops. This is known as the quenched approximation. Recent developments in technology and lattice techniques allow us to avoid this approximation, using instead dynamical fermions which we discuss later.

We can also see from (1.52) that observables are calculated by performing the path integral over all possible vacuum gauge field configurations  $A$ . This concludes our discussion of continuum QCD and the formalism within which observables are calculated.





# Chapter 2

## QCD On the Lattice

As briefly discussed in Chapter 1, QCD is asymptotically free. The coupling constant has the peculiar property that as we study higher energies, or equivalently probe smaller distances, the coupling constant becomes small, enabling us to employ the perturbative techniques used in QED. In the low to moderate energy region in which we live, the coupling constant is large, and the perturbative techniques that one would naturally appeal to are rendered ineffective. It is in this region that we apply the formalism of lattice QCD, discretising space-time onto a 4-D hypercube with spacing  $a$ . Furthermore, while in perturbation theory, regularisation is performed by introducing a momentum cut-off or dimensional regularisation (for example). However, by introducing a minimum distance  $a$ , we also introduce a maximum momentum  $p = \frac{\pi}{a}$ . This regularises the theory, meaning all loop integrals on the lattice are convergent. The formalism of Lattice QCD is currently the only known non-perturbative first-principles approach to studying QCD; that is, amplitudes can be evaluated without the introduction of constraints or parameters. It is this property that makes it particularly attractive. Our goal is therefore to discretise continuum QCD onto the lattice so that the action retains as many features of its continuum counterpart as possible, while avoiding excessive computational cost. The author has found [23, 24] particularly useful as references in writing this section.

### 2.1 The Fermion Action on the Lattice

We begin with the *naive discretisation* of the fermion action. We will see that improvements must necessarily be made to this straightforward discretisation scheme, and we therefore outline the subsequent alteration to our action.

### 2.1.1 The Naive Discretisation

Naturally, the starting point is the discretisation of continuum space-time onto a 4-D hypercube. This is achieved by restricting

$$x^\mu \rightarrow an^\mu \quad (2.1)$$

where  $a$  is the lattice spacing, and  $n^\mu$  are the sites on the lattice. As we obviously have a finite number of CPU hours to run our simulation we restrict ourselves to a finite volume

$$V = L_s^3 L_t = a_s^3 a_t N_s^3 N_t \quad (2.2)$$

where  $N_s$  and  $N_t$  are the number of lattice sites in the spatial and temporal direction respectively,  $a_s$  and  $a_t$  are the relevant spacings with  $L_s$  and  $L_t$  being the corresponding lengths. In our simulations we use a lattice with spacing  $a_s = 0.126\text{fm}$  (with equal spacing in the temporal direction), and  $N_s = 20$ ,  $N_t = 40$  with periodic boundary conditions. For the fermion propagators, we impose periodic boundary conditions in the spatial direction, and fixed boundary conditions in the temporal direction<sup>1</sup>. As we now have quantised space-time, it makes no sense to talk about a derivative or integral as infinitesimal distances are not defined, and hence we replace the derivative with a finite difference

$$\partial_\mu \psi(x) \rightarrow \frac{1}{2a} [\psi(n + \hat{\mu}) - \psi(n - \hat{\mu})]. \quad (2.3)$$

It's also necessary to replace integrals with sums

$$\int d^4x \rightarrow a^4 \sum_x. \quad (2.4)$$

Thus we obtain the lattice free fermion action (setting  $A_\mu = 0$ ) from (1.14) together with (2.4) and (2.3)

$$S_F \Big|_{A_\mu=0} = a^4 \sum_{n \in \mathcal{L}} \bar{\psi}(n) \left[ \sum_{\mu=1}^4 \gamma_\mu \frac{\psi(n + \hat{\mu}) - \psi(n - \hat{\mu})}{2a} + m\psi(n) \right]. \quad (2.5)$$

Recall in Chapter 1 we saw gauge fields necessarily arose by imposing local gauge invariance in the continuum. We now consider the situation on the lattice.

---

<sup>1</sup>We note that the choice of boundary condition in the temporal condition depends on the calculation we are performing as the time-dependence of correlation functions is affected by this choice.

### Gauge Fields in the Fermion Action

The condition for local gauge invariance on the lattice is simply (2.6) with  $x \rightarrow n$ , that is,

$$\psi(n) \rightarrow \psi'(n) = \Omega(n)\psi(n), \quad \bar{\psi}(n) \rightarrow \bar{\psi}'(n) = \bar{\psi}(n)\Omega^\dagger(n). \quad (2.6)$$

We can readily see as in the continuum case, that the mass term is gauge invariant and the  $\bar{\psi}(n)\psi(n + \hat{\mu})$  term is not. Analogously to the case in the continuum, if we define the gauge transformation of the field  $U_\mu(n)$  to be

$$U_\mu(n) \rightarrow U'_\mu(n) = \Omega(n)U_\mu(n)\Omega^\dagger(n + \hat{\mu}), \quad (2.7)$$

then

$$\begin{aligned} \bar{\psi}(n)U_\mu(n)\psi(n + \hat{\mu}) &\rightarrow \bar{\psi}'(n)U'_\mu(n)\psi'(n + \hat{\mu}) \\ &= \bar{\psi}(n)\Omega^\dagger(n)U'_\mu(n)\Omega(n + \hat{\mu})\psi(n + \hat{\mu}) \\ &= \bar{\psi}(n)U_\mu(n)\psi(n + \hat{\mu}), \end{aligned} \quad (2.8)$$

and hence

$$S_F = a^4 \sum_{n \in \mathcal{L}} \bar{\psi}(n) \left[ \sum_{\mu=1}^4 \gamma_\mu \frac{U_\mu(n)\psi(n + \hat{\mu}) - U_{-\mu}(n)\psi(n - \hat{\mu})}{2a} + m\psi(n) \right] \quad (2.9)$$

is gauge invariant. This is the *naive discretisation* of the fermion action. These gauge fields  $U_\mu(n)$ , have both a direction  $\mu$  and position  $n$  associated with them, and hence live on the links between lattice points. For this reason they are often referred to as *link variables*. In (2.9)

$$U_{-\mu}(n) \equiv U_\mu^\dagger(n - \hat{\mu}) \quad (2.10)$$

relates the positively oriented link variable  $U_\mu(n - \hat{\mu})$  to the negatively oriented  $U_{-\mu}(n)$ . Using (2.10) and (2.7), one can immediately show

$$U_{-\mu}(n) \rightarrow U'_{-\mu}(n) = \Omega(n)U_{-\mu}(n)\Omega^\dagger(n + \hat{\mu}), \quad (2.11)$$

and therefore readily verify that the naive fermion action (2.9) is in fact gauge invariant as advertised. However, it is important to note that the link variables  $U_\mu(n)$  which were introduced as elements of the gauge group, must be related to the gauge field  $A_\mu$ , which was introduced as elements of the algebra. It is well known that

$$G(x, y) = P \left[ \exp \left\{ ig \int_C A \cdot ds \right\} \right], \quad (2.12)$$

where  $P$  denotes path ordering and  $G(x, y)$  is the gauge transporter from  $x$  to  $y$  along some curve  $C$ . This has the same transformation properties as  $U_\mu$ . That is, replacing  $U_\mu \rightarrow G(x, y)$ , equation (2.7) is satisfied given the path goes from  $n$  to  $n + \hat{\mu}$ . Therefore, the link variable can be thought of as the lattice version of the gauge transporter between the points  $n$  and  $n + \hat{\mu}$ . The relation between the link variables and the algebra-valued gauge fields can then be written

$$U_\mu(n) = \exp(igaA_\mu(n)), \quad (2.13)$$

where we have approximated the integral in (2.12) along  $C$  from  $n$  to  $n + \hat{\mu}$  by the value of  $A_\mu$  at the starting point  $n$  multiplied by  $a$ . This approximation is good to  $\mathcal{O}(a)$ . By Taylor expanding  $U_\mu(n)$  around  $a = 0$ ,

$$\begin{aligned} U_\mu(n) &= 1 + igaA_\mu(n) + \mathcal{O}(a^2) \\ U_{-\mu}(n) &= 1 - igaA_\mu(n - \hat{\mu}) + \mathcal{O}(a^2) \end{aligned} \quad (2.14)$$

and substituting into (2.9) to  $\mathcal{O}(a^2)$  we obtain

$$\begin{aligned} S_F &= a^4 \sum_n \bar{\psi}(n) \sum_{\mu=1}^4 \left[ \frac{\gamma_\mu (1 + igaA_\mu(n))\psi(n + \hat{\mu}) - (1 - igaA_\mu(n - \hat{\mu}))\psi(n - \hat{\mu})}{2a} + m\psi(n) \right] \\ &= a^4 \sum_n \bar{\psi}(n) \left[ \sum_{\mu=1}^4 \gamma_\mu \frac{\psi(n + \hat{\mu}) - \psi(n - \hat{\mu})}{2a} + m\psi(n) \right] \\ &\quad + \frac{iga^4}{2} \sum_n \sum_{\mu=1}^4 \bar{\psi}(n) \gamma_\mu \left[ A_\mu(n)\psi(n + \hat{\mu}) + A_\mu(n - \hat{\mu})\psi(n - \hat{\mu}) \right] \\ &= a^4 \sum_n \sum_{\mu=1}^4 \bar{\psi}(n) \gamma_\mu \left[ \frac{\psi(n + \hat{\mu}) - \psi(n - \hat{\mu})}{2a} + m\psi(n) + igA_\mu(n)\psi(n) \right] + \mathcal{O}(a) \\ &= S_F \Big|_{A_\mu=0} + S_F^I + \mathcal{O}(a) \end{aligned} \quad (2.15)$$

where we have made use of

$$\begin{aligned} A_\mu(n - \hat{\mu}) &= A_\mu + \mathcal{O}(a) \\ \psi(n \pm \hat{\mu}) &= \psi(n) + \mathcal{O}(a) \end{aligned} \quad (2.16)$$

and  $S_F^I$  denotes the interaction term. It is now straightforward to see that one can recover the continuum fermion action (1.14) from (2.15) in the naive continuum limit  $a \rightarrow 0$ . Unfortunately, this version of the discretised action leads to the infamous fermion doubling problem.

### Fermion Doubling Problem

Observing (2.3), we can see that the central difference will only couple sites that are separated by  $2a$ , meaning even numbered sites are only coupled to other even numbered sites, and odd only to odd. We could therefore expect to get twice the number of possible the fermion species in each dimension, giving a total of  $2^4 = 16$  fermion fields instead of one. In order to further clarify the situation, we write our action in terms of the Dirac operator

$$D_{\alpha\beta}^{ab}(n_1, n_2) = \sum_{\mu=1}^4 \gamma_{\alpha\beta} \frac{U_{\mu}^{ab}(n) \delta_{n+\hat{\mu}, m} - U_{-\mu}^{ab}(n) \delta_{n-\hat{\mu}, m}}{2a} + m \delta_{n_1, n_2} \delta^{ab} \delta_{\alpha\beta}, \quad (2.17)$$

as

$$S_F = a^4 \sum_{n_1, n_2} \sum_{a, b} \sum_{\alpha, \beta} \bar{\psi}_{\alpha}^a(n_1) D_{\alpha\beta}^{ab}(n_1, n_2) \psi_{\beta}^b(n_2). \quad (2.18)$$

Then taking the Fourier transform of our Dirac operator for free fermions (that is for trivial gauge fields), we obtain

$$\begin{aligned} \tilde{D}(p_1, p_2) &= \frac{1}{V} \sum_{n_1, n_2} e^{-ip_1 \cdot n_1 a} D(n_1, n_2) e^{ip_2 \cdot n_2 a} \\ &= \frac{1}{V} \sum_{n_1, n_2} e^{-i(p_1 - p_2) \cdot n_1 a} \left( \sum_{\mu=1}^4 \gamma_{\mu} \frac{e^{ia(p_2)_{\mu}} - e^{-ia(p_2)_{\mu}}}{2a} + m \right) \\ &= \delta(p_1 - p_2) \tilde{D}(p_1) \end{aligned} \quad (2.19)$$

where  $V = Nx \times Ny \times Nz \times Nt$  and

$$\tilde{D}(p_1) = \frac{i}{a} \gamma_{\mu} \sin((p_1)_{\mu} a), \quad (2.20)$$

taking the sum over repeated Lorentz indices  $\mu$  to be implicit. So in order to compute the inverse of the Dirac operator in position space, we can therefore invert  $\tilde{D}(p_1)$  and then invert the Fourier transformation. That is,

$$\tilde{D}^{-1}(n_1, n_2) = \frac{1}{V} \sum_p \tilde{D}^{-1}(p) e^{iap \cdot (n_1 - n_2)}. \quad (2.21)$$

This is the quark propagator. This should come as no surprise upon recalling we showed in (1.4.2) that the fermion propagator could be calculated by inverting the fermion matrix. We know the quark propagator is one of the fundamental objects used in spectroscopic calculations, and as such we postpone a more detailed discussion until (3.4), where we discuss both standard point-to-all propagators and the stochastic estimator techniques that we employ to calculate the so-called

loop elements of the all-to-all propagator. For the purposes of the doubling problem, it is sufficient to consider that calculation of  $\tilde{D}^{-1}(p)$ . Using the identity

$$\left[ a + i\gamma_\mu b_\mu \right]^{-1} = \frac{a - i\gamma_\mu b_\mu}{a^2 + b_\mu b_\mu}, \quad (2.22)$$

for  $a, b_\mu \in \mathbb{R}$ , we obtain

$$\tilde{D}^{-1}(p) = \frac{m + ia^{-1}\gamma_\mu \sin(p_\mu a)}{m^2 + a^{-2}\gamma_\mu \sin(p_\mu a)^2}. \quad (2.23)$$

If we now consider the case of the massless fermion, we have

$$\begin{aligned} \tilde{D}^{-1}(p)|_{m=0} &= \frac{ia^{-1}\gamma_\mu \sin(p_\mu a)}{a^{-2}\gamma_\mu \sin^2(p_\mu a)} \\ &\xrightarrow{a \rightarrow 0} \frac{-i\gamma_\mu p_\mu}{p^2}. \end{aligned} \quad (2.24)$$

We can see that in the continuum the propagator has a single pole at  $p = (0, 0, 0, 0)$ . On the lattice we have additional poles, as the denominator on the first line of (2.24) vanishes when all components of  $p_\mu$  are either 0 or  $\frac{\pi}{a}$ . For each component of  $p$  there are two choices giving  $2^4 = 16$  zeros, the physical zero and 15 unwanted doublers.

## 2.1.2 Wilson Fermions

Having 16 poles instead of 1 is clearly a serious problem, and a possible solution was first suggested by Wilson [1]. By adding an extra term to the Dirac operator we can avoid the unwanted poles, while retaining the correct action in the continuum limit. This extra term is called the Wilson term, and is added to the Dirac operator obtaining,

$$\tilde{D}(p) = m + \frac{i}{a} \sum_{\mu=1}^4 \gamma_\mu \sin(p_\mu a) + \frac{1}{a} \sum_{\mu=1}^4 (1 - \cos(p_\mu a)). \quad (2.25)$$

As before, we can make use of (2.22) to write down the inverse

$$\tilde{D}^{-1}(p) = \frac{m + a^{-1} \sum_{\mu} (1 - \cos(p_\mu a)) - ia^{-1} \gamma_\mu \sin(p_\mu a)}{\left[ m + a^{-1} \sum_{\mu} (1 - \cos(p_\mu a)) \right]^2 + \sum_{\mu} \sin^2(p_\mu a)}. \quad (2.26)$$

Considering the massless case we can see that the only pole is now the physical pole at  $p = (0, 0, 0, 0)$ , as the new term makes a contribution of  $2/a$  at  $p_\mu = \pi/a$ ,

effectively giving the doublers a mass of  $m + 2n/a$  (where  $n$  is the number of momentum components with  $p_\mu = \pi/a$ ). Therefore, in the continuum limit the doublers become infinitely heavy and decouple from the theory. The action can then be succinctly written as

$$S = \int d^4x \bar{\psi}(x) \left[ \not{\nabla} + \frac{ra}{2} \Delta + m \right] \psi(x), \quad (2.27)$$

where the Wilson coefficient  $r$  will be set to unity as is standard,

$$\not{\nabla} = \gamma^\mu \nabla_\mu = \frac{1}{2a} \gamma^\mu [T_\mu - T_\mu^\dagger], \quad (2.28)$$

and

$$\Delta = \frac{1}{a^2} \sum_{\mu=1}^4 [2 - T_\mu - T_\mu^\dagger], \quad (2.29)$$

where we have defined the transport operator  $T_\mu$  as

$$T_\mu \psi(n) = \psi(n + \hat{\mu}), \quad T_\mu^\dagger \psi(n) = \psi(n - \hat{\mu}). \quad (2.30)$$

It is useful to introduce  $T_\mu$  for the gauge field  $U_\mu$  in order to write expressions in terms of operators. This definition allows us to write

$$T_\mu = e^{a\partial_\mu}, \quad T_\mu^\dagger = e^{-a\partial_\mu} \quad (2.31)$$

in the continuum. However, just as we imposed local gauge invariance by replacing  $\partial_\mu$  with  $D_\mu$  we can redefine the continuum version of the transport operators as

$$T_\mu = e^{aD_\mu}, \quad T_\mu^\dagger = e^{-aD_\mu}. \quad (2.32)$$

It can then be shown [34] that this is equivalent to setting  $T_\mu(x) = U_\mu(x)e^{a\partial_\mu}$ , and hence we can put gauge fields on the lattice by defining the transporters to be

$$T_\mu \psi(n) = U_\mu(n) \psi(n + \hat{\mu}), \quad T_\mu^\dagger \psi(n) = U_\mu^\dagger(n - \hat{\mu}) \psi(n - \hat{\mu}). \quad (2.33)$$

We now have a basic formulation for the fermionic part of the action on the lattice. However, when choosing a lattice spacing  $a$ , we are often forced to choose a sufficiently small spacing such that the physics essentially doesn't vary with  $a$ . Failure to do so may mean that taking the naive continuum limit for some observable doesn't yield the desired quantity. It can easily be shown by Taylor expanding the Wilson-Dirac operator  $D_W$  that

$$D_W = \not{D} + \mathcal{O}(a), \quad (2.34)$$

and hence the Wilson fermion action has  $\mathcal{O}(a)$  discretisation errors. It turns out that these  $\mathcal{O}(a)$  errors are relatively large. As the computational cost of the simulation typically increases as some inverse power of  $a$ , actions with large discretisation errors, such as the Wilson action above, are clearly non-optimal. As such, further modification of the action is performed with the goal of reducing the discretisation error, enabling the simulations to be performed at larger lattice spacing and hence lower computational cost. The techniques for doing this are called improvement.

### 2.1.3 Improving the Fermion Action

By definition, it is obvious that some kind of improvement is beneficial. However, which specific method of improvement is best, and how to measure the quality of an improvement scheme is not as clear as we may have imagined. This is because improvement deals with irrelevant operators vanishing in the continuum limit. There does not exist an improvement scheme which fixes everything, and in almost all circumstances there is a price to pay for the improved action, not least of which is rising computational cost. Consequently, certain symmetries present in continuum QCD are non-trivial to maintain on the lattice. In particular chiral symmetry is notoriously difficult to maintain on the lattice. We can see that the Wilson term doesn't anti-commute with  $\gamma_5$  and hence explicitly breaks chiral symmetry. The difficulty in obtaining a chirally symmetric action free of doubled fermion species can be summed up by the well known Nielsen-Ninomiya No-Go theorem [35–37]<sup>2</sup>.

**Nielsen-Ninomiya No-Go Theorem.** It is not possible to find a discretised Dirac operator  $D_a$  such that all the following conditions are simultaneously true.

- $D_a$  has the correct continuum limit that is  $\lim_{a \rightarrow 0} D_a = \not{D}$ , where  $D_\mu$  is the continuum covariant derivative.
- All non-continuum modes of the Dirac operator decouple in the continuum limit. That is we are free from doubled fermion species.
- The norm of the  $D_a$  matrix elements decays exponentially as  $|x - y|$  increases. In this case  $D_a$  is said to be exponentially local.
- $D_a$  does not explicitly break chiral symmetry, that is  $\{D_a, \gamma_5\} = 0$ .

---

<sup>2</sup>Alternatively [38] also contains a good discussion.



This can be avoided by imposing a lattice deformed version of chiral symmetry, obtaining the computationally expensive overlap fermion action [39]. We however work with a cheaper fermion action. It is obvious that if we can afford the computational cost, an action with a smaller discretisation error is preferable. We therefore consider the same spirit used when constructing the Wilson action, permitting ourselves to add terms to the action in order to reduce error given they vanish in the continuum limit. We know that the central difference gives an error of  $\mathcal{O}(a^2)$ , that is

$$\nabla = \not{D} + \mathcal{O}(a^2). \quad (2.35)$$

The Wilson term however introduces errors of  $\mathcal{O}(a)$  as seen in (2.34). In order to remove the  $\mathcal{O}(a)$  error, we first write the Wilson-Dirac operator  $D_W$  in terms of transport operators

$$D_W = \frac{1}{2a} \sum_{\mu=1}^4 2 - [(1 - \gamma_\mu)T_\mu + (1 + \gamma_\mu)T_\mu^\dagger]. \quad (2.36)$$

Then observing  $T_\mu = e^{aD_\mu}$  and  $T_\mu^\dagger = e^{-aD_\mu}$  (2.32), and Taylor expanding we obtain

$$\begin{aligned} D_W &= \frac{1}{2a} \sum_{\mu=1}^4 2 - \left[ \left( (1 - \gamma_\mu) \left( 1 + aD_\mu + \frac{(aD_\mu)^2}{2} + \mathcal{O}(a^3) \right) \right. \right. \\ &\quad \left. \left. + (1 + \gamma_\mu) \left( 1 - aD_\mu + \frac{(aD_\mu)^2}{2} + \mathcal{O}(a^3) \right) \right] \\ &= \sum_{\mu=1}^4 \gamma_\mu D_\mu - \frac{aD_\mu^2}{2} + \mathcal{O}(a^2). \end{aligned} \quad (2.37)$$

Using the identity

$$D_\mu^2 = \not{D}^2 - \frac{1}{4}[\gamma^\mu, \gamma^\nu][D_\mu, D_\nu], \quad (2.38)$$

together with our expression for the field strength tensor in (1.9) we can then write

$$D_W = \not{D} - \frac{a}{2}(\not{D}^2 - \frac{g}{2}\sigma \cdot F) + \mathcal{O}(a^2), \quad (2.39)$$

where we have made use of the definition

$$\sigma_{\mu\nu} = \frac{i}{2}[\gamma_\mu, \gamma_\nu]. \quad (2.40)$$

We can immediately see that any solution to the Dirac equation

$$(\not{D} + m)\psi(x) = 0, \quad (2.41)$$

is also a solution to the Klein-Gordan equation

$$(\not{D} - m)(\not{D} + m)\psi(x) = 0. \quad (2.42)$$

We therefore redefine the bare lattice mass  $m_{\text{bare}}$  to be

$$m_{\text{bare}} = m + \frac{am^2}{2}, \quad (2.43)$$

in order to rewrite (2.39) as

$$D_W + m_{\text{bare}} = \not{D} + m + \frac{ag}{4}\sigma \cdot F + \mathcal{O}(a^2). \quad (2.44)$$

We can now see that an improvement to the Wilson-Dirac operator can easily be made by subtracting off the piece with the field strength tensor (called the clover term) decreasing the discretisation error. This action is known as the Sheikholeslami-Wohlert action [40] and is given by

$$S_{SW} = S_W - \frac{ag}{4}\bar{\psi}(x)\sigma \cdot F\psi(x). \quad (2.45)$$

### 2.1.4 The Field Strength Tensor on the Lattice

In order to properly define the Sheikholeslami-Wohlert action in (2.45) on the lattice, we clearly need a discretised field strength tensor. We begin by briefly digressing to a discussion on an intuitive discretisation used later in the construction of the gauge action, followed by subsequent improvements that facilitate error reduction for use in the fermion action. Beginning with the case in the continuum, we recall from (1.9), that

$$igF_{\mu\nu} = [D_\mu, D_\nu], \quad (2.46)$$

and hence

$$[D_\mu, D_\nu]^\dagger [D_\mu, D_\nu] = g^2 F_{\mu\nu} F_{\mu\nu}, \quad (2.47)$$

as  $D_\mu$  is anti-Hermitian. We can then analogously define a discretised version<sup>3</sup>

$$[\nabla_\mu^+, \nabla_\nu^+]^\dagger [\nabla_\mu^+, \nabla_\nu^+] = g^2 F_{\mu\nu}^+ F_{\mu\nu}^+ \quad (2.48)$$

where

$$\nabla_\mu^+ = \frac{1}{a}(T_\mu - 1). \quad (2.49)$$

---

<sup>3</sup>This discretisation procedure follows the essential steps outlined by Kamleh [24].

We then observe

$$[\nabla_\mu^+, \nabla_\nu^+] = \frac{1}{a^2} [T_\mu, T_\nu], \quad (2.50)$$

letting us write

$$\begin{aligned} g^2 F_{\mu\nu}^+ F_{\mu\nu}^+ &= [\nabla_\mu^+, \nabla_\nu^+]^\dagger [\nabla_\mu^+, \nabla_\nu^+] \\ &= \frac{1}{a^4} [T_\mu, T_\nu] [T_\mu, T_\nu]^\dagger \\ &= \frac{1}{a^4} (T_\mu T_\nu - T_\nu T_\mu) (T_\nu^\dagger T_\mu^\dagger - T_\mu^\dagger T_\nu^\dagger) \\ &= (2 - P_{\mu\nu} - P_{\mu\nu}^\dagger) \end{aligned} \quad (2.51)$$

appealing to the unitarity of  $T_\mu$  on the final line, and setting

$$P_{\mu\nu} = T_\mu T_\nu T_\mu^\dagger T_\nu^\dagger. \quad (2.52)$$

$P_{\mu\nu}$  is known as the plaquette, and is the smallest possible closed loop on the lattice. The plaquette is revisited during the construction of the gauge action in (2.2). We adopt the standard practice of writing

$$P_{\mu\nu} \psi(n) = U_{\mu\nu}(n) \psi(n) \quad (2.53)$$

and henceforth using  $U_{\mu\nu}(n)$ , which is the product of the links  $U$ , starting at the point  $n$  on the lattice, in the order prescribed by (2.52). That is,

$$U_{\mu\nu}(n) = U_\mu(n) U_\nu(n + a\hat{\mu}) U_\mu^\dagger(n + a\hat{\nu}) U_\nu^\dagger(n). \quad (2.54)$$

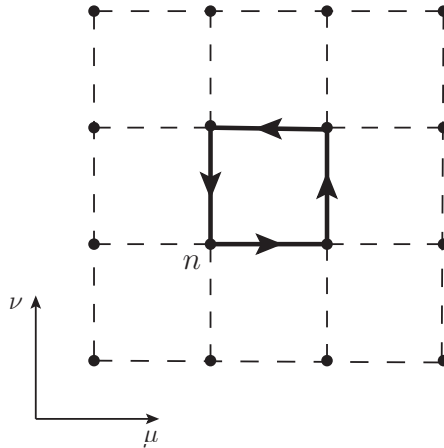

Figure 2.1: The smallest possible closed loop on the lattice, the plaquette  $U_{\mu\nu}(n)$ .

Using (2.54) and (2.51), we can then see

$$g^2 F_{\mu\nu}^+(n) F_{\mu\nu}^+(n) = \frac{1}{a^4} (1 - U_{\mu\nu}^\dagger(n)) (1 - U_{\mu\nu}(n)). \quad (2.55)$$

It is this definition of the field strength tensor that we use later in the construction of the gauge action. However, while the continuum field strength tensor is Hermitian,  $F_{\mu\nu}^+$  as defined above is not. We therefore consider the substitution  $D_\mu \rightarrow \nabla_\mu$  in (1.9),

$$igF_{\mu\nu} = [D_\mu, D_\nu], \quad (2.56)$$

and hence look for a discretised solution  $F_{\mu\nu}^{cl.}$  of

$$[\nabla_\mu, \nabla_\nu] \psi(n) = igF_{\mu\nu}^{cl.}(n) \psi(n). \quad (2.57)$$

We know upon Taylor expanding

$$\begin{aligned} \nabla_\mu &= \frac{1}{2a} (T_\mu - T_\mu^\dagger) = \frac{1}{2a} (e^{aD_\mu} - e^{-aD_\mu}) \\ &= \frac{1}{2a} \left[ \left( 1 + aD_\mu + \frac{(aD_\mu)^2}{2} + \frac{(aD_\mu)^3}{6} + \mathcal{O}(a^4) \right) \right. \\ &\quad \left. - \left( 1 - aD_\mu + \frac{(aD_\mu)^2}{2} - \frac{(aD_\mu)^3}{6} + \mathcal{O}(a^4) \right) \right] \\ &= D_\mu + \frac{1}{6} a^2 D_\mu^3 + \mathcal{O}(a^3), \end{aligned} \quad (2.58)$$

and hence

$$[\nabla_\mu, \nabla_\nu] = [D_\mu, D_\nu] + \mathcal{O}(a^2). \quad (2.59)$$

By performing the Taylor expansions

$$\psi(n + a\hat{\mu}) = \psi(n) + \mathcal{O}(a) \quad U_\mu = 1 + \mathcal{O}(a), \quad (2.60)$$

and appealing to the unitary of the gauge links it can be shown that by expanding (2.57) one can obtain [24]

$$\begin{aligned} [\nabla_\mu, \nabla_\nu] \psi(n) &= \frac{1}{8a^2} \left[ (U_{\mu\nu}(n) - U_{\mu\nu}^\dagger(n)) \psi(n) + (U_{-\nu\mu}(n) - U_{-\nu\mu}^\dagger(n)) \psi(n) \right. \\ &\quad \left. + (U_{\nu-\mu}(n) - U_{\nu-\mu}^\dagger(n)) \psi(n) + (U_{-\mu-\nu}(n) - U_{-\mu-\nu}^\dagger(n)) \psi(n) \right], \end{aligned} \quad (2.61)$$

where we have made use of (2.59) to cancel  $\mathcal{O}(a)$  error terms. We can then define the standard clover  $C_{\mu\nu}$  to be

$$C_{\mu\nu}(n) = \frac{1}{4} (U_{\mu\nu}(n) + U_{-\nu\mu}(n) + U_{\nu-\mu}(n) + U_{-\mu-\nu}(n)). \quad (2.62)$$

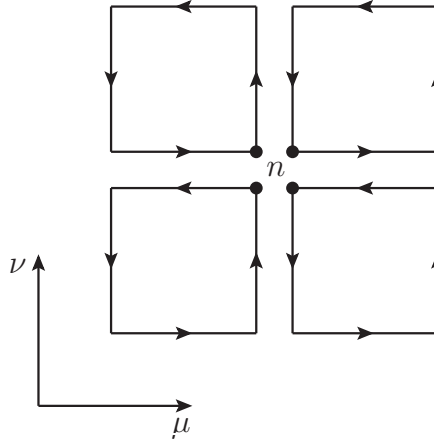
Figure 2.2: The terms that contribute to the clover  $C_{\mu\nu}(n)$ .

In order to satisfy (2.57), the clover discretisation of the field strength tensor  $F_{\mu\nu}^{cl.}(n)$  is then given by

$$F_{\mu\nu}^{cl.}(n) = \frac{1}{2iga^2} (C_{\mu\nu}(n) - C_{\mu\nu}^\dagger(n)), \quad (2.63)$$

which is equal to the continuum field strength tensor up to  $\mathcal{O}(a^2)$ .

However, this clover discretisation has significant  $\mathcal{O}(a^2)$  errors [41]. In the early days of the FLIC action, extra loops terms were added to the clover discretisation [42] in the same spirit as in the fermion action, with the goal of further reducing the discretisation error. To incorporate these higher loop terms we first define

$$F_{\mu\nu}^{m \times n}(n) = \frac{1}{2iga^2} (C_{\mu\nu}^{m \times n}(n) - C_{\mu\nu}^{\dagger m \times n}(n)). \quad (2.64)$$

Here  $C_{\mu\nu}^{m \times n}(n)$  represents the sum of the four  $m \times n$  loops. Although two, three and four loop terms can be added to our expression for the improved field strength tensor in addition to the plaquette term already present, in the interests of lower computational cost the addition of two extra loops was employed. The resulting improved field strength tensor is then given by

$$F_{\mu\nu}^3(n) = \frac{3}{2u_0^4} F_{\mu\nu}^{1 \times 1} - \frac{3}{20u_0^8} F_{\mu\nu}^{2 \times 2} + \frac{1}{90u_0^{12}} F_{\mu\nu}^{3 \times 3}. \quad (2.65)$$

However, more recent work [43] has shown the somewhat remarkable result that the 1-loop clover term is preferable to the 2-loop  $\mathcal{O}(a^2)$ -improved and the 3-loop  $\mathcal{O}(a^4)$ -improved definitions of the lattice field strength tensor. The 1-loop action provides reduced fluctuations in hadron correlators, and hence smaller statistical

uncertainties. This is understood to be as a result of the 1-loop action having more local field strength than the 2-loop or 3-loop actions, meaning it is less susceptible to large fluctuations. We therefore use the 1-loop definition of the field strength tensor given in (2.63).

### 2.1.5 Mean Field Improvement

Here the mean link, or mean field parameter  $u_0$  is defined as the fourth root of the average plaquette

$$u_0 = \left\langle \frac{1}{3} \text{ReTr} U_{\mu\nu}(n) \right\rangle_{n,\mu<\nu}^{\frac{1}{4}}. \quad (2.66)$$

$u_0$  is central to the idea of mean field improvement. Mean field improvement becomes useful when comparing lattice operators to the corresponding continuum operator. In order to perform this comparison, Taylor expansion is performed. For example,

$$U_\mu(n) \rightarrow 1 + iagA_\mu(n). \quad (2.67)$$

However, we encounter problems as higher order terms don't contain increasing powers of  $a$  as we might expect. These terms are referred to as tadpole terms. These tadpole terms have additional powers of  $agA_\mu$ , which exactly cancel the higher powers of  $a$  as  $A_\mu^2 \propto 1/a^2$ . The tadpole terms then go with powers of  $g$ , which in the region of interest are not sufficiently small. The idea of mean field improvement or tadpole improvement is to perform the replacement<sup>4</sup>

$$U_\mu(n) \rightarrow \frac{U_\mu(n)}{u_0} \quad (2.68)$$

in our action and all relevant operators. This has the effect of compensating for the tadpole terms, resulting in an operator with much closer behaviour to the continuum analogue.

### 2.1.6 The FLIC Fermion Action

We are now in a position to discuss the fermion action that has been used in this research, the Fat-Link Irrelevant Clover (FLIC) action and its advantages over the actions encountered thus far. The clover action has the problem of the quark propagator exhibiting singular behaviour at low masses. Consequently, the use of coarse lattices is prevented [45, 46], increasing computational cost. The FLIC

---

<sup>4</sup>For a more detailed discussion of mean field improvement see [44].

action is therefore of interest, as the fermion matrix inversion that is necessary to create propagators and dynamical gauge configurations is more efficient than inversions using Wilson or Clover actions [47]. The use of smeared “fat links” in the irrelevant dimension-5 terms also serve to filter out short distance fluctuations and their associated large perturbative renormalizations of operators. We also use the so-called spin projection trick (outlined in [24, 48, 63]) to reduce computational cost.

When the FLIC action was first conceived, the fat links [49] were computed on APE smeared links [50–52] whereby the links are smeared or “fattened” with a gauge covariant averaging procedure implemented via the replacement

$$\begin{aligned} U_\mu(n) \rightarrow U'_\mu &= (1 - \alpha)U_\mu(n) + \frac{\alpha}{6} \sum_{\pm\nu \neq \mu} U_\nu(n)U_\mu(n + a\hat{\nu})U_\nu^\dagger(n + a\hat{\mu}) \\ &= (1 - \alpha)U_\mu(n) + \frac{\alpha}{6} \sum_{\pm\nu \neq \mu} \Xi_{\mu\nu}^\dagger(n) \end{aligned} \quad (2.69)$$

followed by a projection back to  $SU(3)$  as  $SU(3)$  is not closed under addition. Here  $\alpha$  is the smearing fraction. We then select the unitary matrix  $U_\mu^{FL}$  which maximizes

$$\text{ReTr}(U_\mu^{FL}U_\mu^\dagger), \quad (2.70)$$

by iterating over the three  $SU(2)$  diagonal subgroups of  $SU(3)$ . The smearing and projection procedure is then repeated  $n$  times. However, the projection back to  $SU(3)$  is not unique and is somewhat problematic. We therefore use an alternate smearing procedure known as stout link smearing [53]. In this procedure, we start by taking a weighted sum of staples

$$C_\mu(n) = \rho_{\mu\nu}(n)\Xi_{\mu\nu}(n), \quad (\text{No Sum over } \mu.) \quad (2.71)$$

where  $\rho_{\mu\nu}(n)$  are the weights, which in this research is isotropic and taken to be 0.7. We can then define

$$\Omega_\mu(n) = C_\mu(n)U_\mu^\dagger(n), \quad (2.72)$$

and

$$Q_\mu(n) = \frac{i}{2} \left[ (\Omega_\mu^\dagger(n) - \Omega_\mu(n)) - \frac{1}{N} \text{Tr}(\Omega_\mu^\dagger(n) - \Omega_\mu(n)) \right]. \quad (2.73)$$

$Q_\mu(n)$  is both traceless and Hermitian and its exponential is therefore in  $SU(3)$ . We therefore calculate the fat links via the replacement

$$U_\mu(n) \rightarrow U'_\mu = \exp(iQ_\mu(n))U_\mu(n). \quad (2.74)$$

Note that our isotropic  $\rho_{\mu\nu} = 0.7$  is equivalent to APE smearing to first order. The FLIC action can now be written [47]

$$D_{flc} = \not{\nabla} + \frac{1}{2}(\Delta - \frac{1}{2}\sigma \cdot F) + m, \quad (2.75)$$

where  $\not{\nabla}$ ,  $\Delta$  and  $F$  have all been mean field improved, and  $\Delta$  and  $F$  have been constructed with fat links. Alternatively, it can be written

$$S_{SW}^{FL} = S_W^{FL} - \frac{i\kappa}{2}\bar{\psi}\sigma \cdot F\psi, \quad (2.76)$$

where we have set the (Sheikholeslami-Wohlert) clover coefficient  $C_{SW}$  to its tree level value of 1 and absorbed the mean field improvement into  $F_{\mu\nu}$  in (2.63).  $\kappa = 1/(2m + 8)$  is the quark hopping parameter. Once again, as in (2.75) two sets of links are used. The “normal” links for the naive Dirac operator, and the fat links for the Wilson and clover terms. This is because the process of smearing removes short-distance physics, and hence it is preferable to only smear the irrelevant operators that vanish in the continuum limit.

## 2.2 The Gauge Action on the Lattice

Now that we have discretised the fermion action, we turn our attention to the gauge action. We begin by recalling from (2.54) that the smallest non-trivial closed loop on the lattice is the plaquette

$$U_{\mu\nu}(n) = U_\mu(n)U_\nu(n + a\hat{\mu})U_\mu^\dagger(n + a\hat{\nu})U_\nu^\dagger(n). \quad (2.77)$$

Then making use of (2.13) we obtain

$$U_{\mu\nu}(n) = e^{iagA_\mu(n)}e^{iagA_\nu(n+a\hat{\mu})}e^{-iagA_\mu(n+a\hat{\nu})}e^{-iagA_\nu(n)}. \quad (2.78)$$

As our gauge group is non-Abelian we can't add exponents, and instead use the Baker-Campbell-Hausdorff formula

$$e^A e^B = e^{A+B+\frac{1}{2}[A,B]+\dots}, \quad (2.79)$$



obtaining

$$\begin{aligned}
U_{\mu\nu}(n) &= \exp \left( iagA_\mu(n) + iagA_\nu(n + a\hat{\mu}) - \frac{a^2g^2}{2}[A_\mu(n), A_\nu(n + a\hat{\mu})] + \mathcal{O}(a^3) \right) \\
&\quad \times \exp \left( - iagA_\mu(n + a\hat{\nu}) - iagA_\nu(n) - \frac{a^2g^2}{2}[A_\mu(n + a\hat{\nu}), A_\nu(n)] \right) \\
&= \exp \left( iagA_\mu(n) + iagA_\nu(n + a\hat{\mu}) - \frac{a^2g^2}{2}[A_\mu(n), A_\nu(n + a\hat{\mu})] \right. \\
&\quad - iagA_\mu(n + a\hat{\nu}) - iagA_\nu(n) - \frac{a^2g^2}{2}[A_\mu(n + a\hat{\nu}), A_\nu(n)] \\
&\quad + \frac{a^2g^2}{2} \left[ [A_\mu(n), A_\mu(n + a\hat{\nu})] + [A_\mu(n), A_\nu(n)] \right. \\
&\quad \left. \left. + [A_\nu(n + a\hat{\mu}), A_\mu(n + a\hat{\nu})] + [A_\nu(n + a\hat{\mu}), A_\nu(n)] \right] + \mathcal{O}(a^3) \right). \tag{2.80}
\end{aligned}$$

Then using the Taylor expansions

$$\begin{aligned}
A_\nu(n + \hat{\mu}) &= A_\nu(n) + a\partial_\mu A_\nu(n) + \mathcal{O}(a^2) \\
A_\mu(n + \hat{\nu}) &= A_\mu(n) + a\partial_\nu A_\mu(n) + \mathcal{O}(a^2), \tag{2.81}
\end{aligned}$$

we can show

$$\begin{aligned}
U_{\mu\nu}(n) &= \exp \left( iagA_\mu(n) + iag(A_\nu(n) + a\partial_\mu A_\nu(n)) - iagA_\nu(n) \right. \\
&\quad - iag(A_\mu(n) + a\partial_\nu A_\mu(n)) - \frac{a^2g^2}{2}[A_\mu(n), A_\nu(n) + a\partial_\mu A_\nu(n)] \\
&\quad + \frac{a^2g^2}{2} \left[ [A_\mu(n), A_\mu(n) + a\partial_\nu A_\mu(n)] + [A_\nu(n) + a\partial_\mu A_\nu(n), A_\nu(n)] \right. \\
&\quad \left. + [A_\nu(n) + a\partial_\mu A_\nu(n), (A_\mu(n) + a\partial_\nu A_\mu(n))] + [A_\mu(n), A_\nu(n)] \right] \\
&\quad \left. + \mathcal{O}(a^3) \right) \\
&\quad \vdots \\
&= \exp \left( ia^2g(\partial_\mu A_\nu(n) - \partial_\nu A_\mu(n) + ig[A_\mu(n), A_\nu(n)]) + \mathcal{O}(a^3) \right) \\
&= \exp(a^2[D_\mu, D_\nu] + \mathcal{O}(a^3)) \\
&= \exp(ia^2gF_{\mu\nu} + \mathcal{O}(a^3)), \tag{2.82}
\end{aligned}$$

where we have made use of the expression for the continuum field strength tensor in (1.9) on the final line. Taylor expanding (2.82) we see

$$U_{\mu\nu} = 1 + ia^2gF_{\mu\nu} - \frac{a^4g^2}{4}F_{\mu\nu}F^{\mu\nu} + \mathcal{O}(a^6), \tag{2.83}$$

and hence taking the real part of the trace we can obtain

$$\sum_x \text{Re}[\text{Tr}(I - U_{\mu\nu})] = \sum_x \frac{a^4 g^2}{4} \text{Tr}(F_{\mu\nu} F^{\mu\nu}) + \mathcal{O}(a^6). \quad (2.84)$$

Comparing to the continuum gauge action (1.25), we must be careful when summing over  $\mu$  and  $\nu$  not to double count our plaquettes. There are 6 possible plaquettes corresponding to each combination of  $\mu$  and  $\nu$  such that  $\mu \neq \nu$ , and hence we sum over all combinations such that  $\mu < \nu$ . In doing this we obtain

$$S_G = \frac{a^4}{2} \sum_x \sum_{\mu, \nu} \text{Tr}(F_{\mu\nu} F^{\mu\nu}) = \beta \sum_x \sum_{\mu < \nu} \frac{1}{3} \text{Re}[\text{Tr}(I - U_{\mu\nu})], \quad (2.85)$$

where

$$\beta = \frac{6}{g^2}. \quad (2.86)$$

This discretisation is the Wilson gauge action<sup>5</sup>.

### 2.2.1 Improving the Gauge Action

In the same way as we applied improvement schemes to the fermion action, in particular by adding terms to remove  $\mathcal{O}(a^2)$  errors, we aim to replicate the process with the Wilson gauge action. Using the clover discretisation of the field strength tensor  $F_{\mu\nu}^{cl}$  (2.63) in the gauge action, and expanding using the definition of  $C_{\mu\nu}$  (2.62), we find that not only do we have the plaquette terms but also higher loops of vertical  $R_{\mu\nu}^{2 \times 1}$  and horizontal  $R_{\mu\nu}^{1 \times 2}$  rectangles, as well as a ‘‘half clover’’ loop  $R_{\mu\nu}^{h.cl}$ . To save computational cost, we only incorporate the rectangle terms as the ‘‘half clover’’ has higher multiplicity per lattice site. This gives rise to the plaquette plus rectangle gauge action

$$S_G^{PR} = \frac{\beta}{3} \sum_n \sum_{\mu < \nu} \text{Re}[\text{Tr}\{C_P(1 - U_{\mu\nu}(n)) + C_R(1 - R_{\mu\nu}^{2 \times 1}(n)) + C_R(1 - R_{\mu\nu}^{1 \times 2}(n))\}], \quad (2.87)$$

where the constants  $C_P$  and  $C_R$  determine the relative weightings of the plaquette and rectangle terms. Expanding the Wilson loop corresponding to the plaquette and the rectangle, one can show that a choice of  $C_P = 5/3$ , and  $C_R = -1/12$  will enforce the absence of errors up to  $\mathcal{O}(a^4)$  at tree-level. We also incorporate mean field improvement into the gauge fields to remove the QCD tadpoles as discussed in (2.1.5). The relevant powers of the mean field improvement parameter are

---

<sup>5</sup>For a more detailed discussion see [54].

determined by the number of links present in the term. This results in the tree-level tadpole improved Lüscher-Weisz gauge action [55]

$$S_G^{LW} = \frac{5\beta}{9} \sum_n \sum_{\mu < \nu} \text{Re} \left[ \text{Tr} \left\{ (1 - U_{\mu\nu}(n)) - \frac{1}{20u_0^2} (1 - R_{\mu\nu}^{2 \times 1}(n)) - \frac{1}{20u_0^2} (1 - R_{\mu\nu}^{1 \times 2}(n)) \right\} \right]. \quad (2.88)$$

The improvement scheme can be extended to higher order [56], but beyond one loop lattice perturbation theory becomes particularly laborious. Consequently, further improvements are sometimes made using nonperturbative renormalization-group (RG) inspired improvement.

### RG inspired improvement

So far we have seen the mean field improvement scheme which attempts to construct an action correct up to some order of  $a$ . RG improvement on the other hand is motivated by contemplating an action without cutoff effects. In principle, we can obtain such an action with the following scheme.

- For the set of field variables  $\{\psi\}$  defined with a cutoff  $a$ , introduce a new set of so-called “coarse grained” variables  $\{\Psi\}$  with some new cutoff  $a'$ .
- Integrate out these “coarse grained” variables to obtain a new action

$$e^{-\beta S'(\Psi)} = \int d\psi e^{-\beta[T(\Psi, \psi) + S(\psi)]}. \quad (2.89)$$

Here  $\beta T(\Psi, \psi)$  relates the coarse grained variables to the fine grained ones and is known as the blocking kernel.

The procedure is then repeated multiple times.

However, in repeatedly integrating (2.89), one obtains increasingly complicated actions which are truncated in practice, reducing appeal. In spite of this, two RG improved gauge actions have received interest. These are both constructed with a plaquette and a rectangle

$$S_G^{PR} = \frac{\beta}{3} \sum_n \sum_{\mu < \nu} \text{Re} \left[ \text{Tr} \left\{ C_P (1 - U_{\mu\nu}(n)) + C_R (1 - R_{\mu\nu}^{2 \times 1}(n)) + C_R (1 - R_{\mu\nu}^{1 \times 2}(n)) \right\} \right], \quad (2.90)$$

and have  $\beta_{\text{plaq.}} = \beta c_0$ ,  $\beta_{\text{rect.}} = \beta c_1$ , with the normalization condition  $c_0 + 8c_1 = 1$ . They are known as the Iwasaki action [57] with  $c_1 = -0.331$ , and the doubly-blocked Wilson 2 (DBW2) action [58–61] with  $c_1 = -1.4088$ . This concludes our discussion of the discretisation of QCD on the lattice.



# Chapter 3

## Spectroscopy in Lattice QCD

Now that we have a well-defined formalism for quantising QCD onto the lattice, we proceed by outlining the method for extracting a ground state mass. This begins with a discussion of the method of extracting a mass given a correlation (or two-point Green's) function. The construction of a relevant interpolating operator for the proton,  $\Lambda$  and the  $\Delta^{++}$  is then outlined, and the corresponding correlation functions are calculated at the quark level. We then cover the calculation of both the point-to-all and so-called loop propagators, and the dilution techniques employed in order to reduce the variance of the stochastically estimated loop propagators. This puts us in a position to present effective mass plots for our interpolators.

### 3.1 Correlation Functions at the Baryon Level

We begin by writing down the two-point correlation function<sup>1</sup>  $\mathcal{G}(t, \vec{p})$  in momentum space at the baryon level in the standard way [10, 62, 63]

$$\mathcal{G}(t, \vec{p}) = \sum_{\vec{x}} e^{-i\vec{p}\cdot\vec{x}} \langle 0 | T \chi(x) \bar{\chi}(0) | 0 \rangle, \quad (3.1)$$

where  $T$  denotes time ordering,  $\bar{\chi}$  and  $\chi$  are the creation and annihilation operators respectively, and  $|0\rangle$  denotes the 0-particle vacuum state. On the lattice we consider amplitudes corresponding to propagation forward in time so our time ordering condition is automatically satisfied, allowing us to drop the explicit time ordering. We continue via the insertion of a complete set of states  $B$  with mo-

---

<sup>1</sup>We shall henceforth use the terminology “two-point function” and “correlation function” interchangeably.

momentum  $\vec{p}'$  and spin  $s$ ,

$$\sum_{B, \vec{p}', s} |B, \vec{p}', s\rangle \langle B, \vec{p}', s| = 1, \quad (3.2)$$

obtaining

$$\mathcal{G}(t, \vec{p}) = \sum_{B, \vec{p}', s} \sum_{\vec{x}} e^{-i\vec{p}\cdot\vec{x}} \langle 0 | \chi(x) |B, \vec{p}', s\rangle \langle B, \vec{p}', s | \bar{\chi}(0) | 0\rangle. \quad (3.3)$$

Using the relation

$$\chi(x) = e^{iP\cdot x} \chi(0) e^{-iP\cdot x}, \quad (3.4)$$

with four-momentum  $P$  we then obtain

$$\begin{aligned} \mathcal{G}(t, \vec{p}) &= \sum_{B, \vec{p}', s} \sum_{\vec{x}} e^{-i\vec{p}\cdot\vec{x}} \langle 0 | e^{iP\cdot x} \chi(0) e^{-iP\cdot x} |B, \vec{p}', s\rangle \langle B, \vec{p}', s | \bar{\chi}(0) | 0\rangle \\ &= \sum_{B, \vec{p}', s} e^{-iE_B t} \sum_{\vec{x}} e^{-i\vec{x}\cdot(\vec{p}-\vec{p}')} \langle 0 | \chi(0) |B, \vec{p}', s\rangle \langle B, \vec{p}', s | \bar{\chi}(0) | 0\rangle \\ &= \sum_{B, \vec{p}', s} e^{-iE_B t} \delta_{\vec{p}\vec{p}'} \langle 0 | \chi(0) |B, \vec{p}', s\rangle \langle B, \vec{p}', s | \bar{\chi}(0) | 0\rangle \\ &\rightarrow \sum_{B, s} e^{-E_B t} \langle 0 | \chi(0) |B, \vec{p}, s\rangle \langle B, \vec{p}, s | \bar{\chi}(0) | 0\rangle, \end{aligned} \quad (3.5)$$

where we have transformed into Euclidean space  $t \rightarrow it$ , on the final line. At this stage we can see what our general tactic to compute the energy of some state  $\langle B'', \vec{p}'', s'' |$  might look like. We would pick some operator  $\bar{\chi}$ , that creates a state from the vacuum with the quantum numbers of the state  $\langle B'', \vec{p}'', s'' |$  (with corresponding  $\chi$  that annihilates the state). Then the matrix element  $\langle B, \vec{p}, s | \bar{\chi}(0) | 0\rangle$  will vanish if the state does not have the same quantum numbers as  $\langle B'', \vec{p}'', s'' |$ . The first state that contributes to the sum will be the state  $\langle B, \vec{p}, s | = \langle B'', \vec{p}'', s'' |$ . Other excited states and multi-particle states with higher energies  $\langle B_2, \vec{p}_2, s_2 |$ ,  $\langle B_3, \vec{p}_3, s_3 | \dots$  will have non-zero overlap with  $\bar{\chi}(0) | 0\rangle$ , and hence will also contribute to the sum. However, we can see from (3.5) that states are suppressed exponentially proportional to the energy. Looking at sufficiently large times should then enable the extraction of a ground state mass. We can also simplify equation (3.5) by evaluating the matrix elements. The overlap of  $\chi$  and  $\bar{\chi}$  with the even-parity state  $B^+$  can be written as

$$\begin{aligned} \langle 0 | \chi(0) |B^+, \vec{p}, s\rangle &= \lambda_{B^+} \sqrt{\frac{M_{B^+}}{E_{B^+}}} \gamma_5 u(p_{B^+}, s) \\ \langle B^+, \vec{p}, s | \bar{\chi}(0) | 0\rangle &= -\bar{\lambda}_{B^+} \sqrt{\frac{M_{B^+}}{E_{B^+}}} \bar{u}(p_{B^+}, s) \gamma_5, \end{aligned} \quad (3.6)$$

where  $M_{B^+}$  is the mass of state  $B^+$ ,  $E_{B^+} = \sqrt{M_{B^+}^2 + \vec{p}^2}$  is the energy of state  $B^+$  (with corresponding momentum  $\vec{p}_{B^+}$ ),  $u(p_{B^+}, s)$  and  $\bar{u}(p_{B^+}, s)$  are Dirac spinors, and  $\lambda$  and  $\bar{\lambda}$  are the coupling strengths of the interpolators to the sink and source respectively. Note the presence of the  $\gamma_5$  matrices which invert the parity transformation properties. This is done as the interpolating operators that we will consider transform negatively under parity (see Appendix E), as opposed to the more standard positive parity interpolators (as in [11]). We use the Dirac representation of Bjorken and Drell [64] for the gamma matrices (see Appendix B). We also employ the standard convention of quark fields transforming as  $q(p, s) \rightarrow \gamma_0 q(\tilde{p}, s)$  under parity, where  $\tilde{p} = (p_0, -\vec{p})$  with  $p_0 = \sqrt{\vec{p}^2 + M_{B^+}^2}$  as  $p_{B^+}$  is on shell.

Similarly, for interpolators with a coupling to odd parity states, the expressions for the matrix elements are

$$\begin{aligned} \langle 0 | \chi(0) | B^-, \vec{p}, s \rangle &= \lambda_{B^-} \sqrt{\frac{M_{B^-}}{E_{B^-}}} u(p_{B^-}, s) \\ \langle B^-, \vec{p}, s | \bar{\chi}(0) | 0 \rangle &= \bar{\lambda}_{B^-} \sqrt{\frac{M_{B^-}}{E_{B^-}}} \bar{u}(p_{B^-}, s). \end{aligned} \quad (3.7)$$

Here we have chosen the normalisation factor  $\sqrt{\frac{M_{B^\pm}}{E_{B^\pm}}}$  such that

$$\bar{u}_{B^\pm}^\alpha(p, s) u_{B^\pm}^\beta(p, s) = \delta^{\alpha\beta}. \quad (3.8)$$

Next we can make use of the identity

$$\sum_s u(p, s) \bar{u}(p, s) = \frac{\gamma \cdot p + M}{2M}, \quad (3.9)$$

and the related identity

$$\sum_s \gamma_5 u(p, s) \bar{u}(p, s) \gamma_5 = \frac{-\gamma \cdot p + M}{2M}, \quad (3.10)$$

to write down the even and odd parity contributions to our two-point function. To consider the even parity contribution, we substitute (3.6) and (3.10) into (3.5) obtaining

$$\begin{aligned} \mathcal{G}_{B^+}(t, \vec{p}) &= - \sum_{B^+, s} e^{-E_{B^+} t} \lambda_{B^+} \bar{\lambda}_{B^+} \frac{M_{B^+}}{E_{B^+}} \gamma_5 u(p_{B^+}, s) \bar{u}(p_{B^+}, s) \gamma_5 \\ &= \sum_{B^+} \lambda_{B^+} \bar{\lambda}_{B^+} e^{-E_{B^+} t} \frac{(\gamma \cdot p_{B^+} - M_{B^+})}{2E_{B^+}}, \end{aligned} \quad (3.11)$$

and similarly for the odd parity states substituting (3.7) and (3.9) into (3.5), we obtain

$$\mathcal{G}_{B^-}(t, \vec{p}) = \sum_{B^-} \lambda_{B^-} \bar{\lambda}_{B^-} e^{-E_{B^-} t} \frac{(\gamma \cdot p_{B^-} + M_{B^-})}{2E_{B^-}}. \quad (3.12)$$

We see that at  $\vec{p} = 0$ , the odd parity state will propagate in the upper left Dirac quadrant ((1,1) and (2,2) components) of the two-point function, while the even parity state propagates in the bottom right Dirac quadrant ((3,3) and (4,4) components). This is the opposite case to usual, as the interpolators which we will use transform negatively under parity as opposed to the more widely used positive parity operators. We can therefore apply the parity projection operator

$$\Gamma_{\pm} = \frac{1}{2}(I \mp \gamma_0), \quad (3.13)$$

to our full two-point function

$$\begin{aligned} \mathcal{G}(t, \vec{p}) &= \sum_{B^+} \lambda_{B^+} \bar{\lambda}_{B^+} e^{-E_{B^+} t} \frac{(\gamma \cdot p_{B^+} - M_{B^+})}{2E_{B^+}} \\ &\quad + \sum_{B^-} \lambda_{B^-} \bar{\lambda}_{B^-} e^{-E_{B^-} t} \frac{(\gamma \cdot p_{B^-} + M_{B^-})}{2E_{B^-}}, \end{aligned} \quad (3.14)$$

and take the spinor trace to obtain the parity projected two-point function

$$\begin{aligned} G_{\pm}(t, \vec{0}) &= \text{Tr}_{\text{spinor}}[\Gamma_{\pm} \mathcal{G}(t, \vec{0})] \\ &= \sum_{B^{\pm}} \lambda_{B^{\pm}} \bar{\lambda}_{B^{\pm}} e^{-E_{B^{\pm}} t} \\ &\stackrel{t \rightarrow \infty}{=} \lambda_{0^{\pm}} \bar{\lambda}_{0^{\pm}} e^{-M_{0^{\pm}} t}, \end{aligned} \quad (3.15)$$

where  $0^{\pm}$  labels the lowest energy state with the given set of quantum numbers. The last line is possible as higher energy states are exponentially suppressed proportional to their energy as we have seen. The effective mass of our baryon state can then be written

$$M_{B^{\pm}}^{\text{eff}}(t) = \ln \left( \frac{G_{\pm}(t, \vec{0})}{G_{\pm}(t+1, \vec{0})} \right), \quad (3.16)$$

from which we can obtain the ground state mass as we take the large  $t$  limit as before

$$M_{B^{\pm}}^{\text{eff}}(t) \stackrel{t \rightarrow \infty}{=} M_{0^{\pm}}. \quad (3.17)$$

Our tactic will then be to extract the ground state mass by fitting a constant in time to the effective mass, using a linear least squares fit. We employ the jackknife method in order to obtain a measure of confidence by calculating the error [38, 65].



## 3.2 Interpolating Fields

Now that we can extract a mass given a two-point function at the baryon level, we proceed via the construction of interpolating fields<sup>2</sup> that create a state with the correct set of quantum numbers. Our Baryon states of interest are classified by their parity, total spin and flavour structure, either according to  $SU(2)$  isospin, or  $SU(3)$  flavour. However, in our lattice calculations we impose exact isospin symmetry as is standard, setting  $m_u = m_d$ . The details of the standard two and three quark local interpolators [12–15, 63, 66–68] for the particles relevant to this work are detailed below in Table 3.1.

Particle	Interpolator $\chi(x)$	Isospin I	Isospin Projection $I_3$
Proton $p_3$	$\frac{1}{\sqrt{2}}\epsilon^{abc}(u^{Ta}(x)C\gamma_5d^b(x))u^c(x)$	$\frac{1}{2}$	$+\frac{1}{2}$
Neutron $n$	$\frac{1}{\sqrt{2}}\epsilon^{abc}(u^{Ta}(x)C\gamma_5d^b(x))d^c(x)$	$\frac{1}{2}$	$-\frac{1}{2}$
Pion $\pi^+$	$-\bar{d}^e(x)\gamma_5u^e(x)$	1	+1
Pion $\pi^0$	$-\frac{1}{\sqrt{2}}(\bar{d}^e(x)\gamma_5d^e(x) - \bar{u}(x)^e\gamma_5u^e(x))$	1	0
Kaon $K^-$	$\bar{u}^e(x)\gamma_5s^e(x)$	$\frac{1}{2}$	$-\frac{1}{2}$
Kaon $\bar{K}^0$	$-\bar{d}^e(x)\gamma_5s^e(x)$	$\frac{1}{2}$	$+\frac{1}{2}$
Lambda $\Lambda_3^1$	$+2\epsilon^{abc}(u^{Ta}(x)C\gamma_5d^b(x))s^c(x)$ $-2\epsilon^{abc}(u^{Ta}(x)C\gamma_5s^b(x))d^c(x)$ $+2\epsilon^{abc}(d^{Ta}(x)C\gamma_5s^b(x))u^c(x)$	0	0
Lambda $\Lambda_3^C$	$\frac{1}{\sqrt{2}}\epsilon^{abc}(u^{Ta}(x)C\gamma_5s^b(x))d^c(x)$ $-\frac{1}{\sqrt{2}}\epsilon^{abc}(d^{Ta}(x)C\gamma_5s^b(x))u^c(x)$	0	0
Lambda $\Lambda_3^8$	$\frac{2}{\sqrt{6}}\epsilon^{abc}(u^{aT}(x)C\gamma_5d^b(x))s^c(x)$ $\frac{1}{\sqrt{6}}\epsilon^{abc}(u^{aT}(x)C\gamma_5s^b(x))d^c(x)$ $-\frac{1}{\sqrt{6}}\epsilon^{abc}(d^{aT}(x)C\gamma_5s^b(x))u^c(x)$	0	0

Table 3.1: The classification of the various particles relevant to this work and their corresponding interpolating fields.

The integer subscript explicitly distinguishes the three quark operator inter-

<sup>2</sup>“Interpolating field”, “interpolator” and in some contexts “interpolating operator” are used synonymously.

polator from the five quark interpolator which we are going to see shortly. We also note that neither the proton nor the  $\Delta^{++}$  contain strange quarks and so have strangeness  $S = 0$ , while the Kaons have  $S = -1$ . The various terms also combine in such a way to give the correct flavour structure. For example, the singlet  $\Lambda_3^1$  vanishes under U-spin, V-spin and isospin raising and lowering operators, and hence is a pure flavour singlet. Similarly, applying the isospin raising operator  $I^+$  on  $\chi_3^p$  (for example) we find

$$\begin{aligned}
I^+ \chi_3^p &= \frac{1}{\sqrt{2}} \epsilon^{abc} (u^{Ta}(x) C \gamma_5 u^b(x)) u^c(x) \\
&= \frac{1}{\sqrt{2}} \epsilon^{abc} (u^{Ta}(x) C \gamma_5 u^b(x))^T u^c(x) \\
&= -\frac{1}{\sqrt{2}} \epsilon^{abc} (u^{Ta}(x) C \gamma_5 u^b(x)) u^c(x) \\
&= 0,
\end{aligned} \tag{3.18}$$

where we have freely taken the transpose as the diquark term is a Dirac scalar, and relabeled the colour indices. Therefore, the interpolator is isospin 1/2 as advertised. The process of applying the relevant isospin operator can be similarly repeated for the other interpolators. A discussion of the properties of the above operators under Lorentz and Parity transformations can be found in Appendix E.

However, our aim is to construct multi-particle interpolators, as discussed in the motivation (Section 1.1), so that resonances can be resolved and multi-particle states be identified. We are now in a position to construct these interpolators from the table entries. Beginning with the proton, we aim to construct a nucleon-pion NP-type interpolator with the same quantum numbers as the proton. Similarly, we also construct nucleon-kaon NK-type interpolators for the  $\Lambda$ , and a NP-type interpolator for the  $\Delta^{++}$ .

In the case of the  $\Delta^{++}$  baryon we aim to construct a good candidate to reveal a lowest-lying state consistent with a multi-particle state. For example in Nature, the  $\Delta^{++}$  baryon with  $I(J^P) = \frac{3}{2}(\frac{1}{2}^-)$  has a resonance energy at 1620 MeV. This is to be compared with the two-particle threshold  $M_N + M_\pi = 1080$  MeV. It is with this in mind that we construct our interpolating fields. As isospin is mathematically equivalent to spin, we read off the relevant Clebsch-Gordan coefficients, (see Appendix C) and together with the properties of Table 3.1 we

obtain

$$\chi_5^p(x) = \sqrt{\frac{2}{3}} |n\pi^+\rangle - \sqrt{\frac{1}{3}} |p_3\pi^0\rangle. \quad (3.19)$$

Therefore

$$\begin{aligned} \chi_5^p(x) &= \frac{1}{\sqrt{2}} \epsilon^{abc} \left[ \sqrt{\frac{2}{3}} (u^{Ta}(x)C\gamma_5 d^b(x)) d^c(x) [\bar{d}^e(x)\gamma_5 u^e(x)] \right. \\ &\quad \left. - \sqrt{\frac{1}{3}} \frac{1}{\sqrt{2}} (u^{Ta}(x)C\gamma_5 d^b(x)) u^c(x) [\bar{d}^e(x)\gamma_5 d^e(x) - \bar{u}(x)^e\gamma_5 u^e(x)] \right] \\ &= \frac{1}{2\sqrt{3}} \epsilon^{abc} \left\{ 2(u^{Ta}(x)C\gamma_5 d^b(x)) d^c(x) [\bar{d}^e(x)\gamma_5 u^e(x)] \right. \\ &\quad \left. - (u^{Ta}(x)C\gamma_5 d^b(x)) u^c(x) [\bar{d}^e(x)\gamma_5 d^e(x) - \bar{u}(x)^e\gamma_5 u^e(x)] \right\}. \quad (3.20) \end{aligned}$$

$$\begin{aligned} \chi_5^\Lambda(x) &= \frac{1}{\sqrt{2}} |p_3K^-\rangle - \frac{1}{\sqrt{2}} |n\bar{K}^0\rangle \\ &= \frac{1}{\sqrt{2}} \epsilon^{abc} \left[ (u^{Ta}(x)C\gamma_5 d^b(x)) u^c(x) [\bar{u}^e(x)\gamma_5 s^e(x)] \right. \\ &\quad \left. + (u^{Ta}(x)C\gamma_5 d^b(x)) d^c(x) [\bar{d}^e(x)\gamma_5 s^e(x)] \right]. \quad (3.21) \end{aligned}$$

$$\begin{aligned} \chi_5^{\Delta^{++}} &= |p_3\pi^+\rangle \\ &= \frac{1}{\sqrt{2}} \epsilon^{abc} (u^{Ta}(x)C\gamma_5 d^b(x)) u^c(x) [\bar{d}^e(x)\gamma_5 u^e(x)]. \quad (3.22) \end{aligned}$$

Although our NK-type interpolator for  $\Lambda$  is isospin zero it is not pure flavour singlet, as it does not vanish under U-spin and V-spin raising and lowering operators. In order to construct a pure flavour singlet  $\Lambda$  interpolator we propose

$$\chi_5^\Lambda = |\Lambda_3^1 \eta'\rangle, \quad (3.23)$$

where

$$\eta' = \frac{1}{\sqrt{6}} [\bar{u}^e\gamma_5 u^e + \bar{d}^e\gamma_5 d^e + \bar{s}^e\gamma_5 s^e]. \quad (3.24)$$

Therefore we obtain

$$\begin{aligned} \chi_5^{\Lambda^1} = \frac{2}{\sqrt{6}} \epsilon^{abc} & \left[ (u^{Ta}(x) C \gamma_5 d^b(x)) s^c(x) - (u^{Ta}(x) C \gamma_5 s^b(x)) d^c(x) \right. \\ & \left. + (d^{Ta}(x) C \gamma_5 s^b(x)) u^c(x) \right] \left[ (\bar{u}^e \gamma_5 u^e) + (\bar{d}^e \gamma_5 d^e) + (\bar{s}^e \gamma_5 s^e) \right]. \end{aligned} \quad (3.25)$$

As we know that  $\chi_3^{\Lambda^1}$  is a pure flavour singlet of isospin zero, we can readily see that  $\chi_5^{\Lambda^1}$  also vanishes under U-spin, V-spin and isospin raising and lowering operators, and hence is also an isospin zero pure flavour singlet.

### 3.3 Correlation Functions at the Quark Level

Now that we can extract a mass given a correlation function at the baryon level, and have suitable multi-particle interpolators to create and annihilate our states on to and off of the lattice, we proceed by calculating the correlation function at the quark level given an interpolating field. This amounts to calculating expressions of the form

$$\langle 0 | \chi(x) \bar{\chi}(0) | 0 \rangle, \quad (3.26)$$

and transforming to momentum space in the standard way as specified in equation (3.1). We proceed by rewriting the vacuum expectation value of time-ordered products of field operators in (3.26), as a combinatorics problem involving propagators. The prescription to do this is given by Wick's Theorem (see Appendix D for a more complete discussion)

$$T\{\phi_1 \phi_2 \dots \phi_n\} = : \phi_1 \phi_2 \dots \phi_n + \text{all possible contractions};, \quad (3.27)$$

where the normal ordering of any uncontracted operator gives zero by definition. The contraction of any two fields is then the Feynman propagator. On the lattice we can calculate quark propagators representing the propagation amplitude of the creation of a quark at some space-time point  $x$  with flavour  $f$ , and annihilating the same flavour quark at another space-time point  $y$ . With explicit colour and Dirac indices the propagator  $S_{\alpha\beta}^{ab}(y, x)$  from  $x$  to  $y$  is then given by

$$S_{u,\alpha\beta}^{ab}(y, x) = \langle 0 | u_\alpha^a(y) \bar{u}_\beta^b(x) | 0 \rangle, \quad (3.28)$$

where  $\bar{u}$  and  $u$  create and annihilate quarks with flavour  $u$ . We will see how to calculate this on the lattice in Section 3.4. We now proceed to take all the

contractions for the interpolators in Section 3.2 in order to write our two-point functions in terms of quark propagators. Here we present the two-point functions after we have imposed isospin symmetry, that is set  $S_u = S_d$  or equivalently  $m_u = m_d$ , picked a particular set of  $\gamma$  matrices, and performed colour index relabeling in order to cancel like terms and reduce compute time. The full correlation functions before setting  $S_u = S_d$ , with arbitrary  $\gamma$ -matrices in the interpolator are in Appendix F. The maximally cancelled two-point functions for the NK type  $\Lambda$  interpolator, and the NP type  $\Delta^{++}$  and proton interpolators are given by,

$$\begin{aligned} \mathcal{G}_2^\Lambda(t, \vec{p}) = \sum_{\vec{x}} e^{-i\vec{p}\cdot\vec{x}} \epsilon^{abc} \epsilon^{a'b'c'} \left[ \right. \\ + 2S_u^{aa'}(x, 0)(C\gamma_5)S_u^{e'b'T}(0, 0)\gamma_5 S_s^{ee'T}(x, 0)\gamma_5 S_u^{beT}(x, x)(C\gamma_5)S_u^{cc'}(x, 0) \\ - 4S_u^{ae}(x, x)\gamma_5 S_s^{ee'}(x, 0)\gamma_5 S_u^{e'a'}(0, 0)(C\gamma_5)S_u^{bb'T}(x, 0)(C\gamma_5)S_u^{cc'}(x, 0) \\ - 4S_u^{aa'}(x, 0)(C\gamma_5)S_u^{bb'T}(x, 0)(C\gamma_5)S_u^{ce}(x, x)\gamma_5 S_s^{ee'}(x, 0)\gamma_5 S_u^{e'c'}(0, 0) \\ - 4S_u^{ae}(x, x)\gamma_5 S_s^{ee'}(x, 0)\gamma_5 S_u^{e'a'}(0, 0)\text{Tr}[(C\gamma_5)S_u^{bb'}(x, 0)(C\gamma_5)S_u^{cc'T}(x, 0)] \\ - 2S_u^{aa'}(x, 0)\text{Tr}[(C\gamma_5)S_u^{bb'}(x, 0)(C\gamma_5)S_u^{e'c'T}(0, 0)\gamma_5 S_s^{ee'T}(x, 0)\gamma_5 S_u^{ce'T}(x, x)] \\ + 2S_u^{aa'}(x, 0)(C\gamma_5)S_u^{bb'T}(x, 0)(C\gamma_5)S_u^{cc'}(x, 0)\text{Tr}[\gamma_5 S_s^{ee'}(x, 0)\gamma_5 S_u^{e'e}(0, x)] \\ \left. + 2S_u^{aa'}(x, 0)\text{Tr}[(C\gamma_5)S_u^{bb'}(x, 0)(C\gamma_5)S_u^{cc'T}(x, 0)]\text{Tr}[\gamma_5 S_s^{ee'}(x, 0)\gamma_5 S_u^{e'e}(0, x)]\right]. \end{aligned} \quad (3.29)$$

$$\begin{aligned} \mathcal{G}_2^{\Delta^{++}}(t, \vec{p}) = \sum_{\vec{x}} e^{-i\vec{p}\cdot\vec{x}} \epsilon^{abc} \epsilon^{a'b'c'} \left[ \right. \\ + S_u^{aa'}(x, 0)\text{Tr}[(C\gamma_5)S_u^{be}(x, x)\gamma_5 S_u^{eb'}(x, 0)(C\gamma_5)S_u^{e'c'T}(0, 0)\gamma_5 S_u^{ce'T}(x, 0)] \\ + S_u^{aa'}(x, 0)(C\gamma_5)S_u^{e'b'T}(0, 0)\gamma_5 S_u^{be'T}(x, 0)(C\gamma_5)S_u^{ce}(x, x)\gamma_5 S_u^{e'c'}(x, 0) \\ + S_u^{ae'}(x, 0)\gamma_5 S_u^{e'a'}(0, 0)(C\gamma_5)S_u^{eb'T}(x, 0)\gamma_5 S_u^{beT}(x, x)(C\gamma_5)S_u^{cc'}(x, 0) \\ - S_u^{aa'}(x, 0)(C\gamma_5)S_u^{e'b'T}(0, 0)\gamma_5 S_u^{ee'T}(x, 0)\gamma_5 S_u^{beT}(x, x)(C\gamma_5)S_u^{cc'}(x, 0) \\ - S_u^{ae'}(x, 0)\gamma_5 S_u^{e'a'}(0, 0)(C\gamma_5)S_u^{bb'T}(x, 0)(C\gamma_5)S_u^{ce}(x, x)\gamma_5 S_u^{e'c'}(x, 0) \\ - S_u^{aa'}(x, 0)\text{Tr}[(C\gamma_5)S_u^{be}(x, x)\gamma_5 S_u^{ee'}(x, 0)\gamma_5 S_u^{e'b'}(0, 0)(C\gamma_5)S_u^{cc'T}(x, 0)] \\ - S_u^{aa'}(x, 0)\text{Tr}[(C\gamma_5)S_u^{bb'}(x, 0)(C\gamma_5)S_u^{ec'T}(x, 0)\gamma_5 S_u^{e'eT}(0, x)\gamma_5 S_u^{ce'T}(x, 0)] \\ - S_u^{aa'}(x, 0)(C\gamma_5)S_u^{bb'T}(x, 0)(C\gamma_5)S_u^{cc'}(x, 0)\gamma_5 S_u^{e'e}(0, x)\gamma_5 S_u^{e'c'}(x, 0) \\ - S_u^{ae'}(x, 0)\gamma_5 S_u^{e'e}(0, x)\gamma_5 S_u^{ea'}(x, 0)(C\gamma_5)S_u^{bb'T}(x, 0)(C\gamma_5)S_u^{cc'}(x, 0) \\ + S_u^{aa'}(x, 0)(C\gamma_5)S_u^{bb'T}(x, 0)(C\gamma_5)S_u^{cc'}(x, 0)\text{Tr}[\gamma_5 S_u^{ee'}(x, 0)\gamma_5 S_u^{e'e}(0, x)] \\ \left. - S_u^{ae'}(x, 0)\gamma_5 S_u^{e'e}(0, x)\gamma_5 S_u^{ea'}(x, 0)\text{Tr}[(C\gamma_5)S_u^{bb'}(x, 0)(C\gamma_5)S_u^{cc'T}(x, 0)]\right] \end{aligned}$$

$$+ S_u^{aa'}(x, 0) \text{Tr} \left[ (C\gamma_5) S_u^{bb'}(x, 0) (C\gamma_5) S_u^{cc'^T}(x, 0) \text{Tr} \left[ \gamma_5 S_u^{ee'}(x, 0) \gamma_5 S_u^{e'e}(0, x) \right] \right]. \quad (3.30)$$

$$\begin{aligned} \mathcal{G}_2^p(t, \vec{p}) = & \sum_{\vec{x}} e^{-i\vec{p}\cdot\vec{x}} \epsilon^{abc} \epsilon^{a'b'c'} \left[ \right. \\ & + 5S_u^{aa'}(x, 0) \text{Tr} \left[ (C\gamma_5) S_u^{be}(x, x) \gamma_5 S_u^{b'f}(x, 0) (C\gamma_5) S_u^{c'e^T}(0, 0) \gamma_5 S_u^{ce'^T}(x, 0) \right] \\ & - 5S_u^{aa'}(x, 0) \text{Tr} \left[ (C\gamma_5) S_u^{be}(x, x) \gamma_5 S_u^{ee'}(x, 0) \gamma_5 S_u^{e'b'}(0, 0) (C\gamma_5) S_u^{cc'^T}(x, 0) \right] \\ & + 9S_u^{aa'}(x, 0) (C\gamma_5) S_u^{b'f^T}(x, 0) \gamma_5 S_u^{be^T}(x, x) (C\gamma_5) S_u^{ce'}(x, 0) \gamma_5 S_u^{e'c'}(0, 0) \\ & - 9S_u^{aa'}(x, 0) (C\gamma_5) S_u^{bb'^T}(x, 0) (C\gamma_5) S_u^{ce}(x, x) \gamma_5 S_u^{ee'}(x, 0) \gamma_5 S_u^{e'c'}(0, 0) \\ & + 9S_u^{ae}(x, x) \gamma_5 S_u^{ea'}(x, 0) (C\gamma_5) S_u^{e'b'^T}(0, 0) \gamma_5 S_u^{b'e'^T}(x, 0) (C\gamma_5) S_u^{cc'}(x, 0) \\ & - 9S_u^{ae}(x, x) \gamma_5 S_u^{ee'}(x, 0) \gamma_5 S_u^{e'a'}(0, 0) (C\gamma_5) S_u^{bb'^T}(x, 0) (C\gamma_5) S_u^{cc'}(x, 0) \\ & - 9S_u^{aa'}(x, 0) (C\gamma_5) S_u^{b'f^T}(x, 0) \gamma_5 S_u^{e'e^T}(0, x) \gamma_5 S_u^{b'e'^T}(x, 0) (C\gamma_5) S_u^{cc'}(x, 0) \\ & + 6S_u^{aa'}(x, 0) (C\gamma_5) S_u^{bb'^T}(x, 0) (C\gamma_5) S_u^{cc'}(x, 0) \text{Tr} \left[ \gamma_5 S_u^{ee'}(x, 0) \gamma_5 S_u^{e'e}(0, x) \right] \\ & - 9S_u^{ae}(x, x) \gamma_5 S_u^{ea'}(x, 0) (C\gamma_5) S_u^{bb'^T}(x, 0) (C\gamma_5) S_u^{ce'}(x, 0) \gamma_5 S_u^{e'c'}(0, 0) \\ & - 9S_u^{ae}(x, x) \gamma_5 S_u^{ee'}(x, 0) \gamma_5 S_u^{e'a'}(0, 0) \text{Tr} \left[ (C\gamma_5) S_u^{bb'}(x, 0) (C\gamma_5) S_u^{cc'^T}(x, 0) \right] \\ & - 5S_u^{aa'}(x, 0) \text{Tr} \left[ (C\gamma_5) S_u^{bb'}(x, 0) (C\gamma_5) S_u^{cc'^T}(x, 0) \gamma_5 S_u^{e'e^T}(0, x) \gamma_5 S_u^{ce'^T}(x, 0) \right] \\ & + 6S_u^{aa'}(x, 0) \text{Tr} \left[ (C\gamma_5) S_u^{bb'}(x, 0) (C\gamma_5) S_u^{cc'^T}(x, 0) \right] \text{Tr} \left[ \gamma_5 S_u^{ee'}(x, 0) \gamma_5 S_u^{e'e}(0, x) \right] \\ & - 3S_u^{ae'}(x, 0) \gamma_5 S_u^{e'a'}(0, 0) (C\gamma_5) S_u^{b'f^T}(x, 0) \gamma_5 S_u^{be^T}(x, x) (C\gamma_5) S_u^{cc'}(x, 0) \\ & + 3S_u^{ae'}(x, 0) \gamma_5 S_u^{e'a'}(0, 0) (C\gamma_5) S_u^{bb'^T}(x, 0) (C\gamma_5) S_u^{ce}(x, x) \gamma_5 S_u^{e'c'}(x, 0) \\ & + 3S_u^{ae}(x, x) \gamma_5 S_u^{ea'}(x, 0) \text{Tr} \left[ (C\gamma_5) S_u^{be'}(x, 0) \gamma_5 S_u^{e'b'}(0, 0) (C\gamma_5) S_u^{cc'^T}(x, 0) \right] \\ & + 3S_u^{aa'}(x, 0) (C\gamma_5) S_u^{bb'^T}(x, 0) (C\gamma_5) S_u^{ce'}(x, 0) \gamma_5 S_u^{e'e}(0, x) \gamma_5 S_u^{e'c'}(x, 0) \\ & + 3S_u^{ae'}(x, 0) \gamma_5 S_u^{e'e}(0, x) \gamma_5 S_u^{ea'}(x, 0) (C\gamma_5) S_u^{bb'^T}(x, 0) (C\gamma_5) S_u^{cc'}(x, 0) \\ & + 3S_u^{ae'}(x, 0) \gamma_5 S_u^{e'e}(0, x) \gamma_5 S_u^{ea'}(x, 0) \text{Tr} \left[ (C\gamma_5) S_u^{bb'}(x, 0) (C\gamma_5) S_u^{cc'^T}(x, 0) \right] \\ & - 3S_u^{aa'}(x, 0) (C\gamma_5) S_u^{e'b'^T}(0, 0) \gamma_5 S_u^{be'^T}(x, 0) (C\gamma_5) S_u^{ce}(x, x) \gamma_5 S_u^{e'c'}(x, 0) \\ & + 3S_u^{aa'}(x, 0) (C\gamma_5) S_u^{e'b'^T}(0, 0) \gamma_5 S_u^{ee'^T}(x, 0) \gamma_5 S_u^{be^T}(x, x) (C\gamma_5) S_u^{cc'}(x, 0) \\ & - 3S_u^{ae}(x, x) \gamma_5 S_u^{ea'}(x, 0) \text{Tr} \left[ (C\gamma_5) S_u^{bb'}(x, 0) (C\gamma_5) S_u^{c'e^T}(0, 0) \gamma_5 S_u^{ce'^T}(x, 0) \right] \\ & + 3S_u^{ae'}(x, 0) \gamma_5 S_u^{e'a'}(0, 0) \text{Tr} \left[ (C\gamma_5) S_u^{be}(x, x) \gamma_5 S_u^{b'f}(x, 0) (C\gamma_5) S_u^{cc'^T}(x, 0) \right] \\ & - S_u^{aa'}(x, 0) \text{Tr} \left[ (C\gamma_5) S_u^{b'e'}(x, 0) \gamma_5 S_u^{e'e}(0, x) \gamma_5 S_u^{b'f}(x, 0) (C\gamma_5) S_u^{cc'^T}(x, 0) \right] \\ & - 3S_u^{ae'}(x, 0) \gamma_5 S_u^{e'a'}(0, 0) \text{Tr} \left[ (C\gamma_5) S_u^{bb'}(x, 0) (C\gamma_5) S_u^{cc'^T}(x, 0) \gamma_5 S_u^{ce'^T}(x, x) \right] \\ & \left. + S_u^{aa'}(x, 0) \text{Tr} \left[ (C\gamma_5) S_u^{be'}(x, 0) \gamma_5 S_u^{e'b'}(0, 0) (C\gamma_5) S_u^{cc'^T}(x, 0) \gamma_5 S_u^{ce^T}(x, x) \right] \right] \end{aligned}$$

$$- S_u^{aa'}(x, 0) \text{Tr} \left[ (C\gamma_5) S_u^{bb'}(x, 0) (C\gamma_5) S_u^{e'e'^T}(0, 0) \gamma_5 S_u^{ee'^T}(x, 0) \gamma_5 S_u^{ce'^T}(x, x) \right]. \quad (3.31)$$

Due to the size of the correlation function for  $\chi_5^{\Lambda^1}$ , it is not presented here. Instead it can be found in Appendix F.

### 3.4 Propagators

We can see from the two-point functions in the preceding section that we require four different “types” of propagators corresponding to the four combinations of 0 and  $x$  for the source and sink points in (3.28).

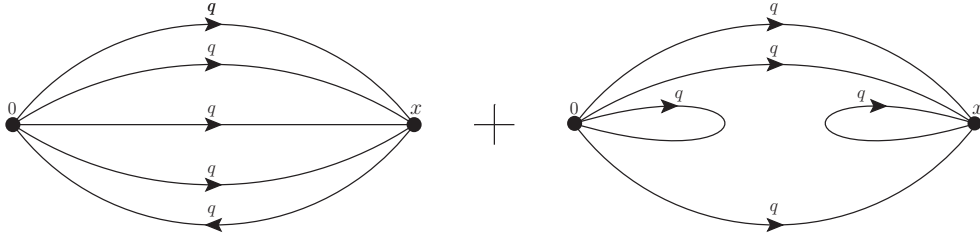

Figure 3.1: The “fully-connected” (left) and “loop-containing” (right) contributions to the two-point functions given in section (3.3) for the five quark operators in section (3.2). Note the four “types” of propagators we require to evaluate such diagrams.

The calculation of the point-to-all propagator  $S(x, 0)$  has been a crucial component of spectroscopy on the lattice since the origin of such investigations owing to its omnipresence in the two-point functions of the mesons and baryons. The standard method of computation is in principle straightforward, although calculating propagators is the most computationally costly step in this research. Following on from (1.49) where we showed the propagator was the inverse of the fermion matrix, we solve

$$M_{\alpha\beta}^{ab} S_{\beta\lambda}^{bc} = \eta_{\alpha}^a \quad (3.32)$$

for some source vector  $\eta$  by performing a matrix inversion for each colour index  $c$  and Dirac index  $\lambda$ . This amounts to  $n_c \times n_d = 12$  inversions, which are calculated via the BiStabilised Conjugate Gradient algorithm [69]. The so-called all-to-point propagators  $S(0, x)$  are also easily calculated by appealing to the propagator’s  $\gamma_5$ -

hermiticity property

$$(\gamma_5 S_{\alpha\beta}^{ab}(x, 0) \gamma_5)^* = S_{\beta\alpha}^{ba}(0, x), \quad (3.33)$$

which relates the backward propagating propagator or anti-quark propagator to the forwards propagating one. The loop propagator at the source  $S(0, 0)$ , is also easy to calculate by virtue of it being a subset of the values stored in  $S(x, 0)$ . As  $S(x, 0)$  stores values representing propagation amplitudes from one point on the lattice 0 to all other points  $x$ , setting  $x = 0$  gives the loop propagator at the source. That is,

$$S(0, 0) = S(x, 0)|_{x=0}. \quad (3.34)$$

However, the loop propagator at  $x$ ,  $S(x, x)$  requires a different approach. While not impossible with the latest supercomputers, calculating  $S(x, x)$  with the same algorithm, that is performing (3.32) for each  $x$  is sufficiently expensive to discourage its use. In addition, it would also be a terrible waste of resources as we would have effectively calculated the all-to-all propagator while only requiring the  $x$  to  $x$  loop propagator.

We therefore resort to the standard method to calculate all-to-all propagators, via stochastically estimating inverse matrix elements. An excellent introductory discussion can be found in [70, 72]. We begin by generating an ensemble of random independent column noise vectors  $\eta_1 \dots \eta_N$  with the properties of white noise [70]. That is,

$$\langle \eta(x) \otimes \eta^\dagger(y) \rangle = \delta_{xy}, \quad (3.35)$$

where  $\langle \dots \rangle$  denotes the expectation value over the noise vectors, and each component of  $\eta$  has modulus 1

$$\eta_\alpha^a(x) * \eta_\alpha^{a*}(x) = 1. \quad (\text{No sum.}) \quad (3.36)$$

We can then obtain solution vectors by inverting against the fermion matrix in the same way we did when calculating the point-to-all propagator. We therefore obtain a solution vector  $\chi_i(x)$  for each corresponding noise vector  $\eta_i$  via solving

$$\chi_i(x) = M^{-1} \eta_i(y). \quad (3.37)$$

The stochastic estimate of the all-to-all quark propagator is then given by [70, 71]

$$M^{-1}(y, x)_{\alpha\beta}^{ab} = \langle \chi \otimes \eta^\dagger \rangle_{\alpha\beta}^{ab} = \lim_{N \rightarrow \infty} \frac{1}{N} \sum_{i=1}^N \chi_{\alpha,i}^a(y) \eta_{\beta,i}^{\dagger b}(x). \quad (3.38)$$

We simply set  $y = x$  in (3.38) to calculate our loop propagators. Any noise that satisfies (3.35) and (3.36), will work, but some will work better than others. As



our technique converges to the exact result as  $N \rightarrow \infty$ , we consider the variance of an element of the inverse matrix as a rough measure of the “goodness” of the noise. It has been shown that the variance of an inverted matrix element due to our stochastic estimation method is given by [73]

$$\text{Var}(M_{\alpha\beta}^{-1}) = \frac{1}{N} \left[ (M_{\alpha\beta}^{-1})^2 C^2 + \sum_{\gamma \neq \beta} (M_{\alpha\gamma}^{-1})^2 \right], \quad (3.39)$$

where

$$C = \sqrt{\frac{1}{N} \sum_i (\langle \eta_i \eta_i^* \rangle - 1)^2}, \quad (3.40)$$

is a measure of the deviation of the diagonal element  $\eta_i \eta_i^*$  from unity. The second term in (3.39) is independent of the noise chosen and hence we want to pick a noise with minimal diagonal error. Consequently  $Z_2$  [71, 72],  $Z_4$  [75, 76] and  $U(1)$  [74] noises have been all been previously used owing to their vanishing diagonal error<sup>3</sup>. We use the sufficient  $Z_2$  noise, which gives similar results to  $Z_4$  or  $U(1)$  noise [74].

However, simply applying the above prescription results in unsatisfactorily large errors [78], and hence we employ a variance reduction technique known as dilution [71, 78]. Rather than invert the fermion matrix with the entire noise source as in (3.37), we first “dilute” the noise vectors such that it only has support for a particular set of indicies. Dilution is performed in time, spin and colour indicies such that

$$\eta_\alpha^a(\vec{x}, t) = \sum_{b, \beta, t'} \eta_{\alpha\beta}^{ab, t'}(\vec{x}, t), \quad (3.41)$$

where

$$\eta_{\alpha\beta}^{ab, t'}(\vec{x}, t) = \delta_{\alpha\beta} \delta^{ab} \delta_{tt'} \eta_\alpha^a(\vec{x}, t). \quad (\text{No summation}). \quad (3.42)$$

We now invert the fermion matrix as in (3.37) for each of our diluted sources  $\eta_{\alpha\beta}^{ab, t'}(\vec{x}, t)$ , and obtain the corresponding solution vectors  $\chi_{\gamma\beta}^{cb, t'}(\vec{x}, t)$ . The “dilution improved” stochastic estimate of our loop propagators at  $x$  for a single noise vector is then given by

$$S_{\gamma\alpha}^{ca}(\vec{x}, \vec{x}) = \sum_{b, \beta, t'} \chi_{\gamma\beta}^{cb, t'}(\vec{x}, t) \eta_{\alpha\beta}^{ab, t'}(\vec{x}, t). \quad (3.43)$$

To obtain the stochastic estimate for multiple noise vectors, Equation (3.43) can be calculated for each noise vector and the average taken.

---

<sup>3</sup>We note that the latest techniques to stochastically estimate elements of the all-to-all propagator (such as the Laplacian Heavyside quark smearing technique employed in [75–77]) are more involved than the computationally cheaper technique presented here.

In order to calculate our propagators, we require a typical snapshot of the gauge field, a gauge configuration. These are created in the standard way via Hybrid Monte Carlo using the dynamical FLIC action for the sea quarks. Excellent discussions of the algorithm can be found in [24, 79].

To decide on how much dilution is necessary and how many noise vectors are sufficient, we proceed by calculating

$$\langle \text{Tr}[\Gamma S(x, x)] \rangle \quad (3.44)$$

for the interleaved time dilution and full time dilution cases. In the process of employing interleaved time dilution, the noise vector is given support only on certain time-slices. Using interleaved 4-time dilution would therefore consist of performing calculations with a noise vector that only has support on every 4<sup>th</sup> time-slice. Here  $\langle \dots \rangle$  denotes the averaging over all space-time points and gauge configurations. Full spin and colour dilution is performed in both cases. We can also compare this stochastic estimation with a similar expression containing a point-to-all propagator

$$\langle \text{Tr}[\Gamma S(x, 0)|_{x=0}] \rangle, \quad (3.45)$$

where  $\langle \dots \rangle$  now denotes averaging over gauge configurations only, and we set  $x = 0$  in order to read off the “loop” element. In order to save computational time, this initial testing was performed with 100 quenched  $16^3 \times 24$  lattices at  $\beta = 6.0$  using the Wilson action with  $\kappa = 0.148$ . Results for various choices of  $\Gamma$  are shown for one noise vector in Tables 3.2 and 3.3 for full and interleaved time dilution respectively. These can be compared with the trace values calculated with  $S(x, 0)|_{x=0}$  in Table 3.4. Results for two noise vectors are shown in 3.5 and 3.6.

It is important to note that the values derived from  $S(x, x)$  have been averaged over all spatial points and time-slices  $5 \rightarrow 20$ . Taking the average over all space-time points would encounter contamination from the fixed boundary conditions in the temporal direction. The value derived from  $S(x, 0)|_{x=0}$  is at a single space-time point one quarter of the way in from the boundary in the temporal direction, that is at  $(1, 1, 1, 6)$  on our  $16^3 \times 24$  lattices. In the interests of readability we have retained four decimal places in all but the last entry.

We can see that apart from the trace of the propagator, all the other terms are either consistent with zero or close to consistent with zero. This is expected, as we know the tree-level propagator is proportional to  $\gamma \cdot p + m$ . It would therefore not be unreasonable to expect that taking the trace with a  $\gamma$ -matrix gives zero as

$\Gamma$	$\text{Re}\langle\text{Tr}[\Gamma S(x, x)]\rangle$	Jackknife error
$\gamma_1$	$-4.4394 \times 10^{-04}$	$2.5849 \times 10^{-04}$
$\gamma_2$	$+4.9721 \times 10^{-04}$	$2.5041 \times 10^{-04}$
$\gamma_3$	$-1.8418 \times 10^{-04}$	$2.6838 \times 10^{-04}$
$\gamma_4$	$+5.1559 \times 10^{-10}$	$2.3169 \times 10^{-10}$
$I$	11.236305	0.000319

Table 3.2: The values of various traces for the stochastically estimated propagator with full spin, colour and time dilution. The average is taken over all space-time points and gauge configurations. One noise vector has been used.

there is no preferred direction. Simply taking the trace picks up the mass term which would be non-zero. In fact, the value for the quark condensate can be calculated in a similar fashion<sup>4</sup>. We can also take encouragement in comparing Table 3.2 with Table 3.3.

$\Gamma$	$\text{Re}\langle\text{Tr}[\Gamma S(x, x)]\rangle$	Jackknife error
$\gamma_1$	$-4.5228 \times 10^{-4}$	$2.5935 \times 10^{-4}$
$\gamma_2$	$+4.9581 \times 10^{-4}$	$2.5228 \times 10^{-4}$
$\gamma_3$	$-1.9181 \times 10^{-4}$	$2.6848 \times 10^{-4}$
$\gamma_4$	$+6.6066 \times 10^{-6}$	$9.8755 \times 10^{-6}$
$I$	11.236319	0.000318

Table 3.3: The values of various traces for the stochastically estimated propagator with full spin and colour dilution and interleaved 4-time dilution. The average is taken over all space-time points and gauge configurations. One noise vector has been used.

<sup>4</sup>To calculate a condensate, whether it be a quark condensate or quark-gluon condensate the essential object is the loop propagator  $S(x, x)$ . The condensate then goes as the  $\text{Tr}[S(x, x)]$  (in the case of the quark condensate) or  $\sum_{\mu\nu} \text{Tr}[S(x, x)\sigma_{\mu\nu}G_{\mu\nu}]$  (in the case of the quark-gluon condensate) for example. A more detailed discussion of condensates can be found in [80, 81].

The full time diluted results, that is the results where the noise vector has support on every time slice, are all quite similar to the the interleaved 4-time diluted results where the noise vector only has support on every fourth time slice. In particular the trace of the propagator shows encouraging agreement, perhaps initially suggesting that interleaved time dilution may be sufficient.

We now compare the numbers for the various traces of  $S(x, x)$  presented in Tables 3.2 and 3.3, with the same traces using  $S(x, 0)|_{x=0}$  presented in Table 3.4. Once again, encouragement can be taken from the relatively big and precise value for the  $\Gamma = I$  case and consistency or near consistency with zero for the other values. The overlapping error bars are of significant encouragement, particularly for the  $\Gamma = I$  case.

$\Gamma$	$\text{Re}\langle\text{Tr}[\Gamma S(x, 0) _{x=0}]\rangle$	Jacknife error
$\gamma_1$	$+1.0065 \times 10^{-9}$	$1.2455 \times 10^{-9}$
$\gamma_2$	$+0.1208 \times 10^{-9}$	$1.1319 \times 10^{-9}$
$\gamma_3$	$+2.6777 \times 10^{-3}$	$0.9258 \times 10^{-3}$
$\gamma_4$	$-4.9245 \times 10^{-4}$	$9.2896 \times 10^{-4}$
$I$	11.237010	0.006640

Table 3.4: The values of various traces for the standard point-to-all propagator, with the “all”  $x$  set to the “point value”, to make a loop. The average is taken over gauge configurations.

It is now instructive to compare our results using a single noise vector, to those obtained averaging over two noise vectors. Results for the trace values using two noise vectors are presented in Tables 3.5 and 3.6.

$\Gamma$	$\text{Re}\langle\text{Tr}[\Gamma S(x, x)]\rangle$	Jacknife error
$\gamma_1$	$-0.1930 \times 10^{-4}$	$1.8348 \times 10^{-4}$
$\gamma_2$	$-0.8029 \times 10^{-4}$	$1.6775 \times 10^{-4}$
$\gamma_3$	$-0.6087 \times 10^{-4}$	$1.6129 \times 10^{-4}$
$\gamma_4$	$+1.3703 \times 10^{-5}$	$0.8115 \times 10^{-5}$
$I$	11.235797	0.000265

Table 3.5: The values of various traces for the stochastically estimated propagator with full spin and colour dilution and interleaved 4-time dilution. Two noise vectors are averaged over in addition to the averaging over all space-time points and gauge configurations.

$\Gamma$	$\text{Re}\langle\text{Tr}[\Gamma S(x, x)]\rangle$	Jacknife error
$\gamma_1$	$-0.1798 \times 10^{-04}$	$1.8434 \times 10^{-04}$
$\gamma_2$	$-0.8979 \times 10^{-04}$	$1.6649 \times 10^{-04}$
$\gamma_3$	$-0.8798 \times 10^{-04}$	$1.5973 \times 10^{-04}$
$\gamma_4$	$-1.2291 \times 10^{-10}$	$1.7619 \times 10^{-10}$
$I$	11.235784	0.000264

Table 3.6: The values of various traces for the stochastically estimated propagator with full spin, colour and time dilution. Two noise vectors are averaged over in addition to the averaging over all space-time points and gauge configurations.

Ideally, we would like to observe the same level of error in both the one noise vector and two noise vector cases, indicating the uncertainty is entirely dominated by gauge noise. However, while the errors are not invariant, the error generally decreases by less than a factor of  $\sqrt{2}$ . In addition, the trace values for the diluted cases are more precisely determined than those for the standard point-to-all case,

also suggesting one noise vector may be sufficient. It is helpful to recall that in the full dilution limit, that is performing full dilution in all space-time, spin and colour indices, we would be calculating  $S(x, x)$  exactly. Thus, increasing the level of dilution will allow acceptable results to be obtained with less noise vectors. We therefore propose to use full spin, colour and time dilution with one noise vector per gauge configuration.

In order to test the veracity of our proposition we calculate the pion correlator (motivated by Appendix A2 in [82]). This can be done simply by performing the replacement  $x = 0$  in Equation (3.38) rather than  $x = y$ . Equipped with a stochastic estimate of the point-to-all propagator  $S(x, 0)$ , we can calculate the aforementioned pion correlation function. The corresponding mass plots are presented in Figures 3.2 and 3.3. Attempting to produce similar plots with interleaved time dilution yields an effective mass plot with spikes wherever the noise vector has support. The use of interleaved time dilution is therefore avoided.

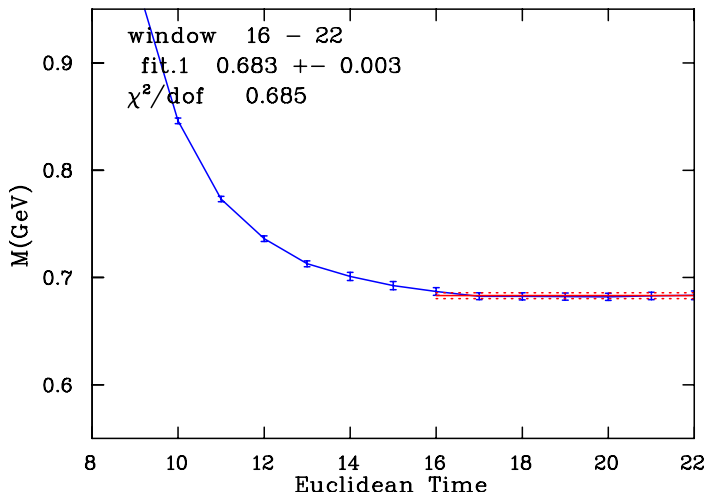

Figure 3.2: An effective mass plot for the pion using the stochastically estimated  $S(x, 0)$  in the pion correlation function.

A quick comparison shows virtually identical effective mass plots. It is important to recall, that although the stochastic  $S(x, 0)$  is created via the use of noise vectors while the standard  $S(x, 0)$  is not, the stochastic propagator also requires more  $N_t = 24$  times more inversions if one considers all time slices. We note the opportunity for savings by calculating only at the time slices of interest (e.g.  $t = 14 - 22$  in this case). For our results in Chapter 4 we use full dilution with one noise vector per gauge configuration.

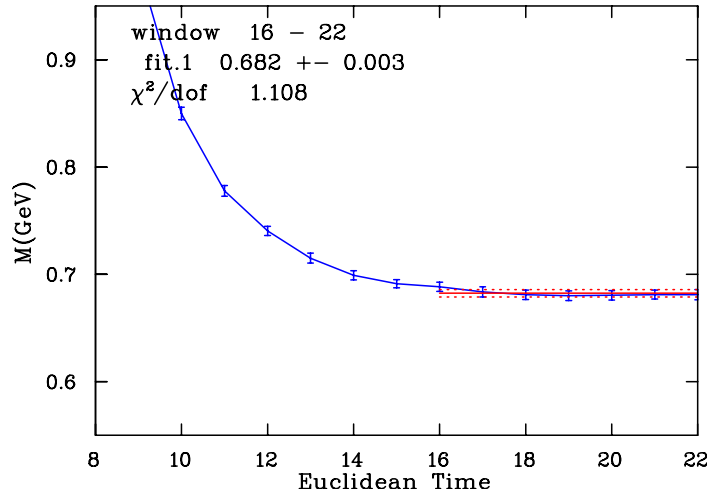

Figure 3.3: An effective mass plot for the pion using the standard point-to-all propagator  $S(x, 0)$  in the pion correlation function.

At this point it is worthwhile to briefly summarize our progress for clarity. We have constructed relevant multi-particle interpolators, with the same quantum numbers as the corresponding three-quark state. The calculation of two-point functions was then performed with these interpolators, and all the relevant technology required for the calculation of the various propagators in the correlation function was presented. Now using the method outlined in Section (3.1) we can extract masses for the two-point functions calculated. This puts us in a position to present effective mass plots for the various interpolators.





# Chapter 4

## Simulation Results

Here we present correlation function plots and effective mass plots for the five quark operators, in addition to the standard three quark interpolator plots which are used for comparison. As the  $\Lambda$  plots are presented at the  $SU(3)$  flavour limit, there is a corresponding degeneracy in various correlation functions which is demonstrated in Appendix F. Once a plot has been presented, further degenerate cases will not be shown. Rather, a brief reference will be made to the plot in question.

The Euclidean time scale shown for the correlation functions corresponds to the time over which the fit is performed. Naturally, the time scale is truncated to show only the region of interest within which the fit was performed. All the fit windows shown are selected via consideration of the covariance-matrix based  $\chi^2/\text{dof}$ , as is standard. The solid line shows the fit, while the error bars are depicted with dashed lines. For this study we use 75  $(2 + 1)$ -flavour dynamical  $20^3 \times 40$  lattices with the FLIC action and  $\beta = 3.94$ ,  $\kappa_s = 0.1324$ . The lattice spacing is 0.126 fm in the temporal and spatial directions.

We note here that although one cannot take the fully-connected and loop-containing pieces of the correlation function by themselves in a fully rigorous manner, the results are presented keeping in mind future correlation matrix analysis. A pictorial representation of the loop-containing and fully-connected pieces of the correlation function was presented in Figure 3.1.

## 4.1 The Even-Parity Proton

### 4.1.1 Correlation Functions

We begin by presenting the correlation functions relevant for the even-parity proton. In addition to performing the calculation for the standard three-quark nucleon at zero momentum, we also present results for the nucleon and pion with one unit of momentum each. This is necessary as we are looking at the positive parity state from the five-quark interpolator, and wish to compare this to the  $E_N + E_\pi$  energy level. As the pion has negative parity and the nucleon has positive parity, we must give each one unit of momentum to have overlap with a positive parity state with relative orbital angular momentum  $l = 1$ . These extracted energies are used in the  $E_N + E_\pi$  energy level shown. In the same way, when dealing with the negative parity state in Section 4.2 we compare with  $M_N + M_\pi$ .

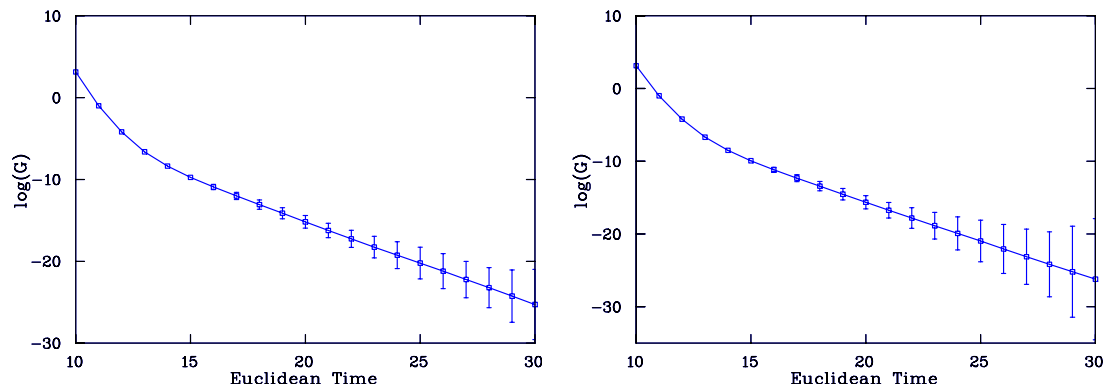

(a) A correlation function plot of the standard three-quark nucleon operator at zero momentum.

(b) A correlation function plot for the standard three-quark nucleon operator with one unit of momentum.

Figure 4.1: Correlation function plots for the three-quark nucleon operator with zero momentum and one unit of momentum.

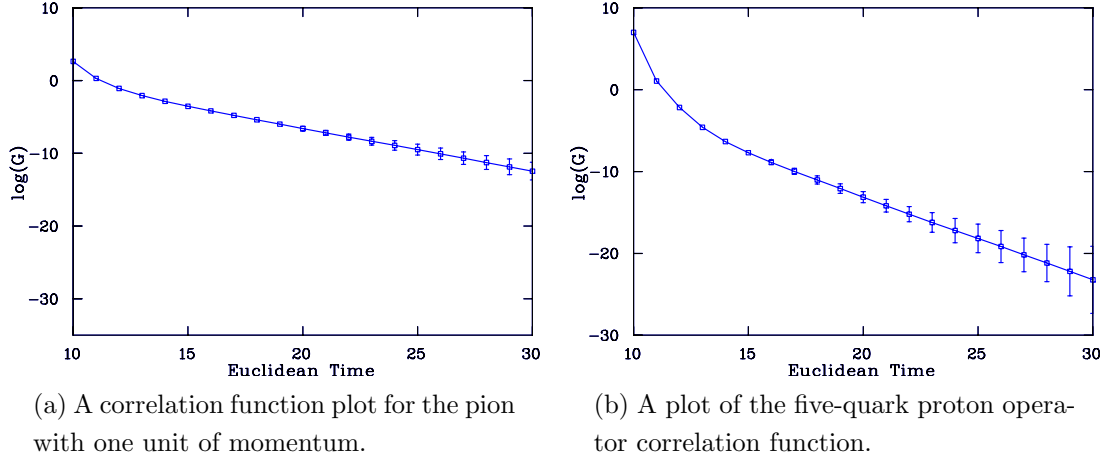

Figure 4.2: Correlation function plots for the pion and five-quark proton operator. We can observe that the correlator for the five-quark proton operator is very similar to the correlator obtained for the standard three-quark nucleon shown in Figure 4.1 (b).

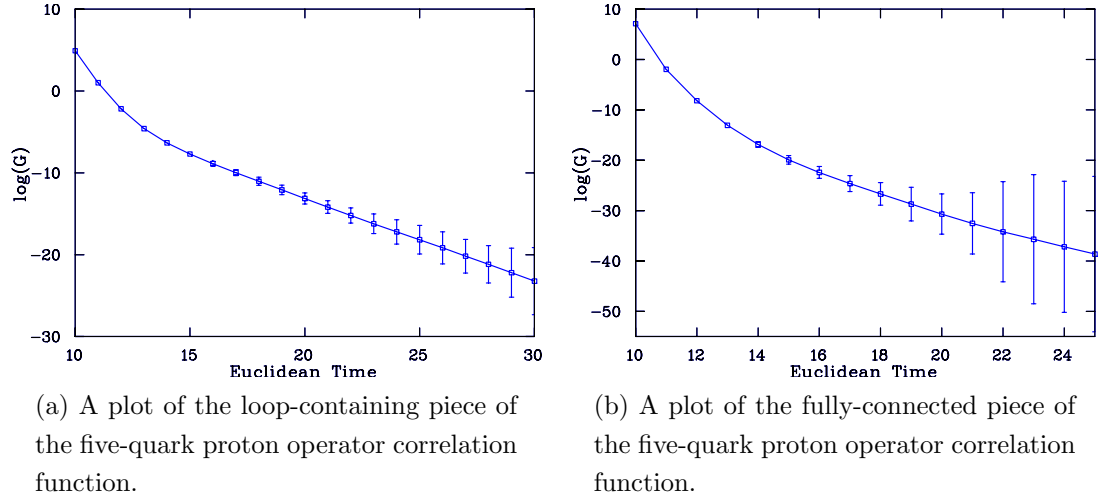

Figure 4.3: The correlation function plots for the loop-containing and fully-connected pieces of the five-quark proton operator. We observe that the loop-containing piece of the five-quark proton operator in (a) is virtually indistinguishable from the total five-quark operator correlation function in Figure 4.2 (b), indicating that this piece is the dominant contribution.

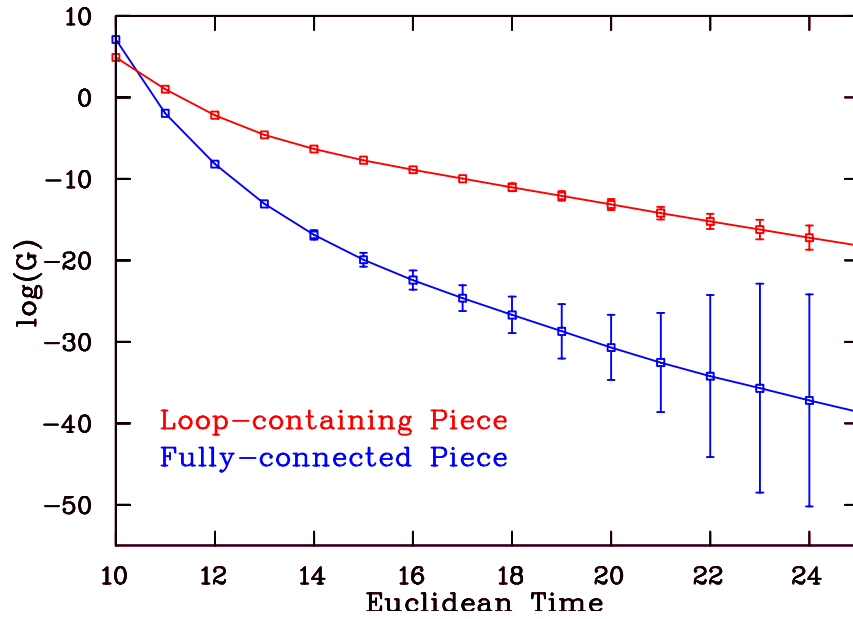

Figure 4.4: A comparison of the loop-containing and fully-connected pieces of the five-quark proton operator correlation function. Here we observe the fully-connected piece has a greater slope indicating this piece is associated with more massive contributions.

### 4.1.2 Effective Mass Plots

The effective mass plots corresponding to the correlators plotted in the previous section are shown here.

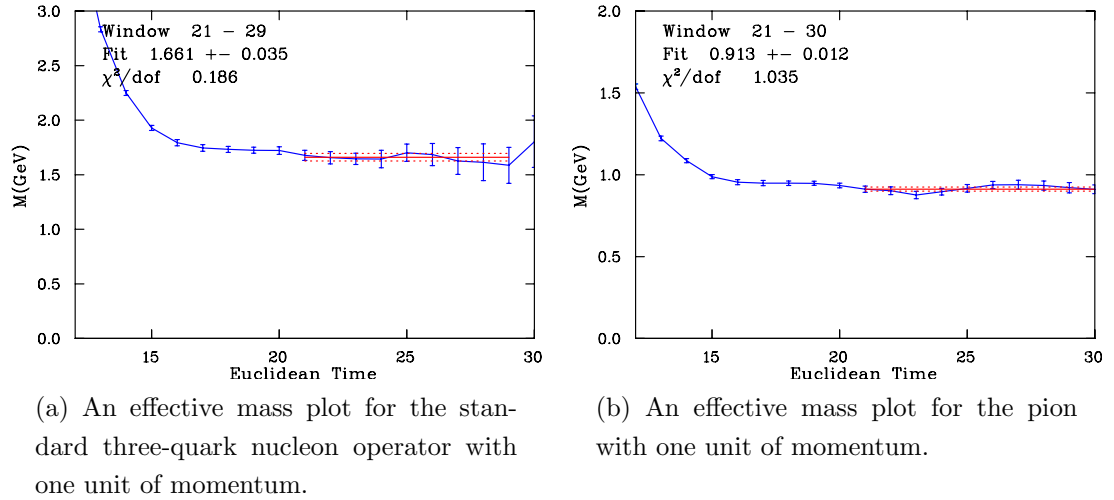

Figure 4.5: Effective Mass plots for the nucleon and pion with one unit of momentum each.

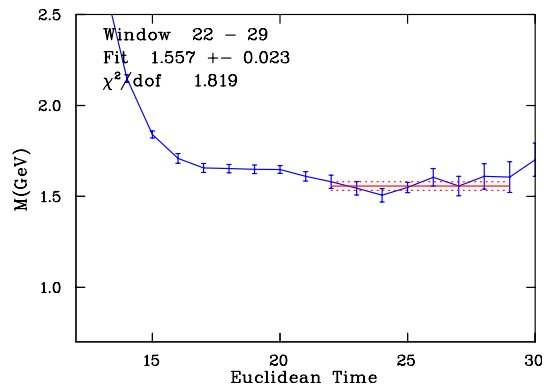

Figure 4.6: An effective mass plot for the standard three-quark nucleon operator at zero momentum.

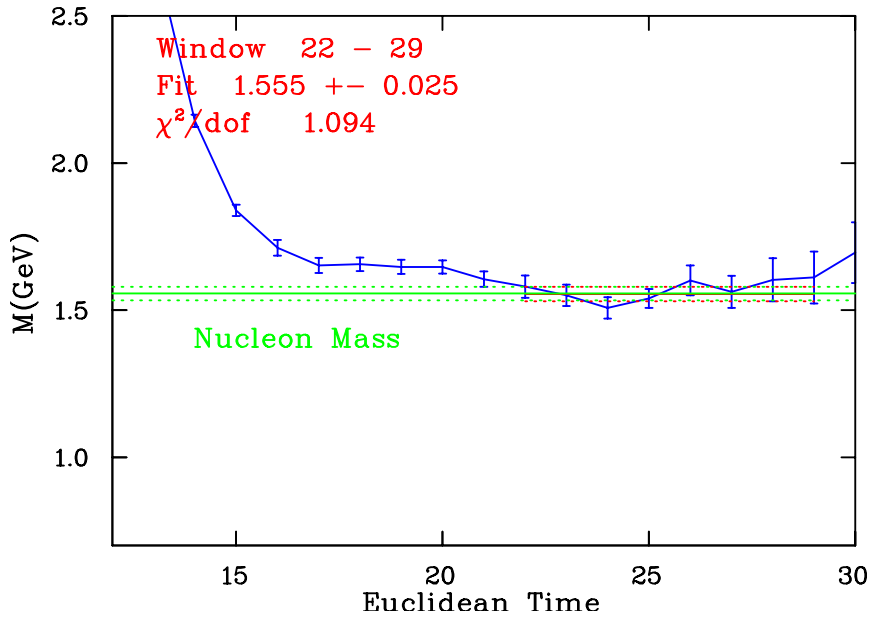

Figure 4.7: A mass plot for the five-quark proton operator compared to the extracted three-quark nucleon result at zero momentum shown in Figure 4.6.

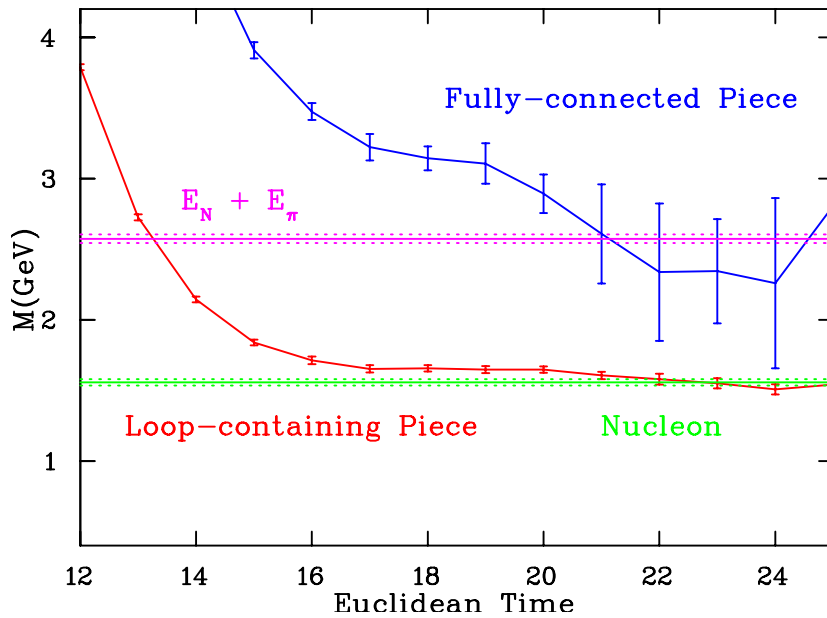

Figure 4.8: A comparison of the effective mass plots for the fully-connected and loop-containing pieces. Recall that the total correlation function is almost entirely dominated by the disconnected piece, and as such they are virtually indistinguishable.

It is encouraging to note that the fully-connected piece of the correlation function appears to be displaying substantial overlap with a more exotic state before decaying to a  $N + \pi$  state. This suggests that further studies using correlation matrix techniques will successfully enable the extraction of more states. Furthermore, the form of this piece looks similar to that of pentaquarks (studied in [62] for example), which also possesses a pure five-quark connected piece diagram as its correlator.

The error bars on this piece of the correlation function are clearly of significant size, and further work, in particular with new GPU's, will enable more inversions to be performed and hence will reduce uncertainties. We also observe that the five-quark mass plot is completely dominated by the loop-containing piece of the correlation function. We know from earlier chapters that our signal decays exponentially proportional to the mass, and hence such a result is not unexpected. This mass extracted from the five-quark operator displays good agreement with the mass obtained from the corresponding three-quark operator, indicating that the possibility of quark annihilation is vital to obtaining a low-lying mass. It will be interesting to study this effect in the limit of light quark masses.

## 4.2 The Odd-Parity $N^*$

### 4.2.1 Correlation Functions

We now turn our attention to the odd-parity  $N^*$  and present the relevant correlation function plots.

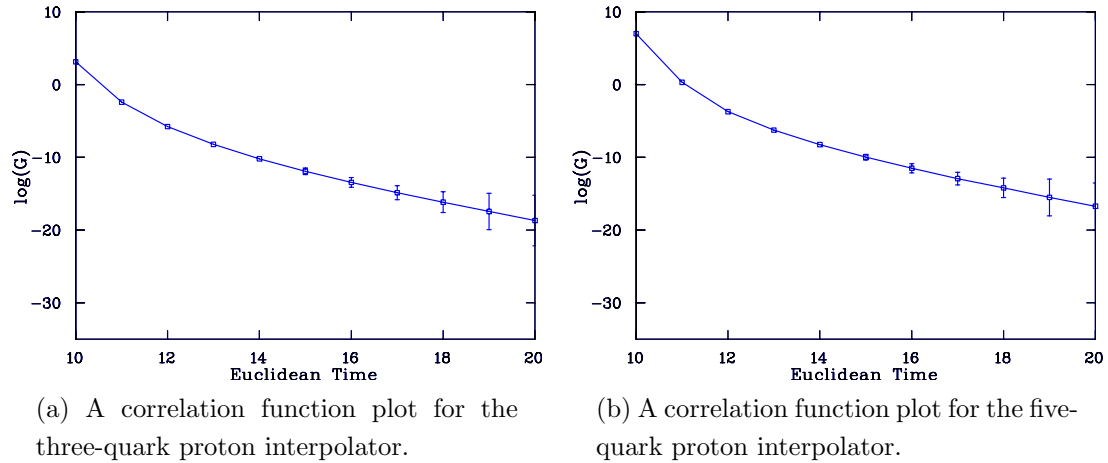

Figure 4.9: Correlation function plots for the three-quark and five-quark proton interpolators.

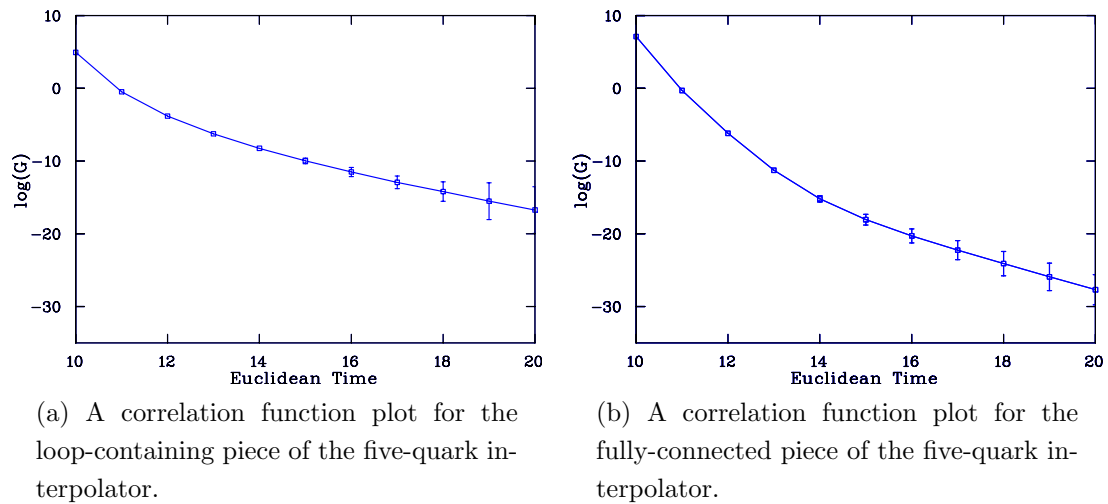
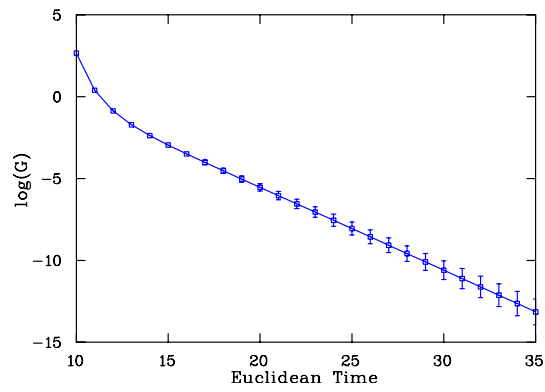

Figure 4.10: Correlation function plots for the loop-containing and fully-connected pieces of the five-quark proton interpolator.





(a) A plot of the pion correlation function at zero momentum.

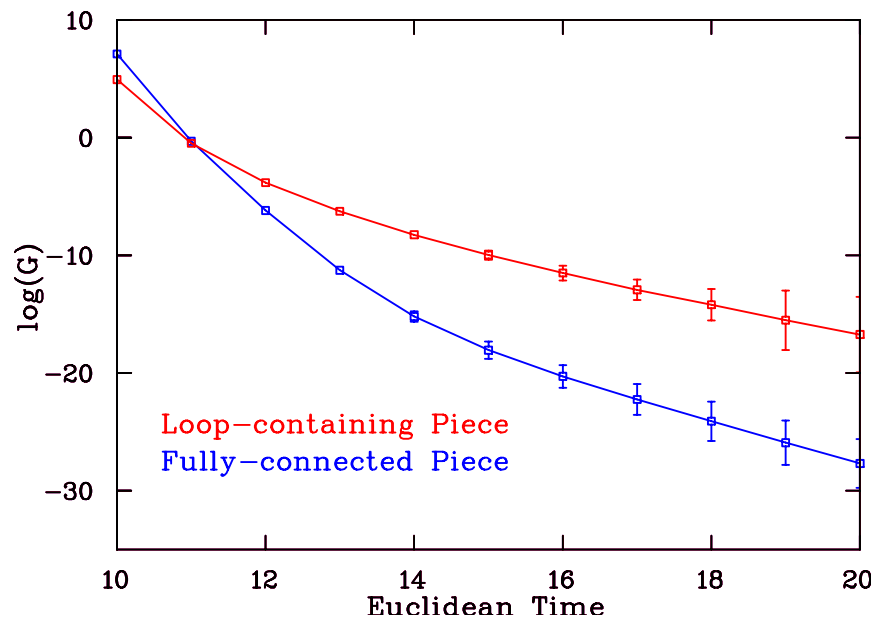

Figure 4.11: A comparison of the loop-containing and fully-connected pieces of the five-quark proton correlation functions.

### 4.2.2 Effective Mass Plots

The effective mass plots corresponding to the correlators in the previous section are presented here.

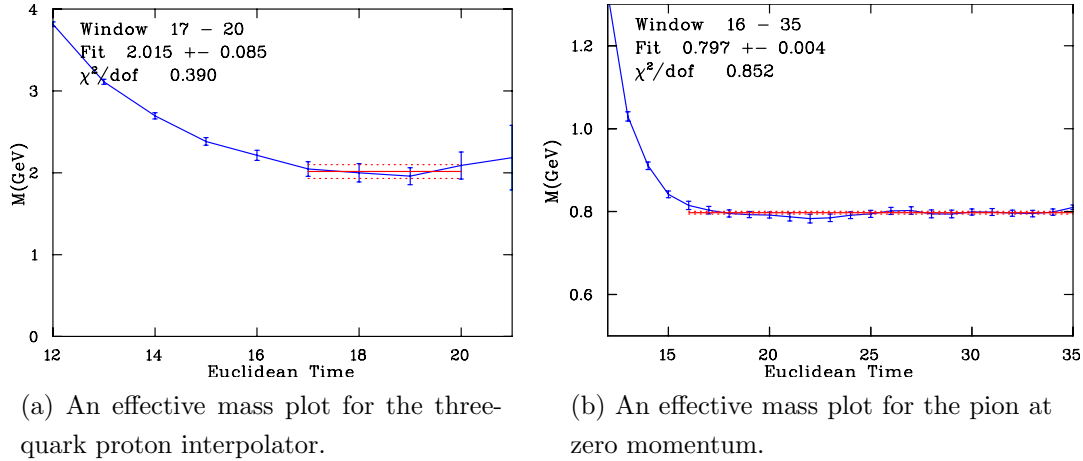

Figure 4.12: Effective Mass plots for the three-quark proton operator and the pion at  $\vec{p} = 0$ .

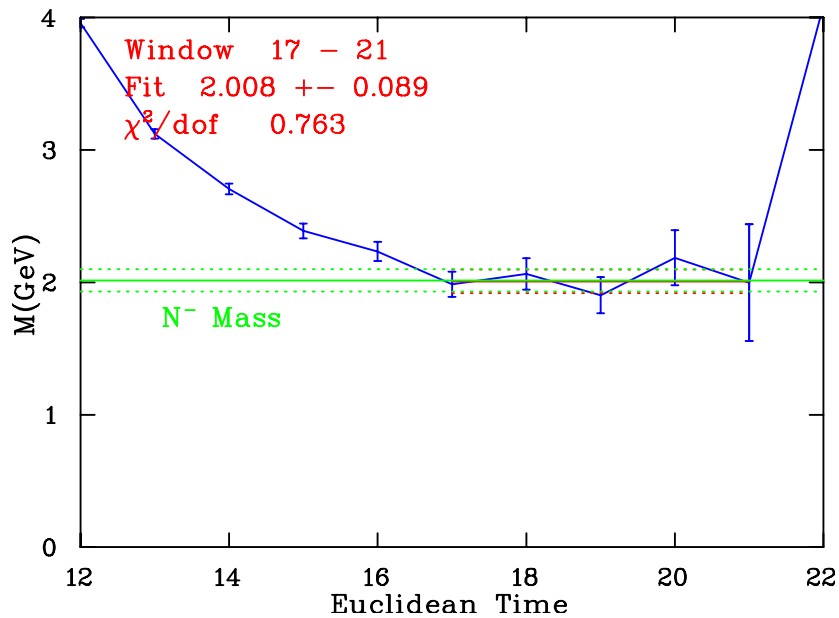

Figure 4.13: An effective mass plot for the five-quark proton operator.

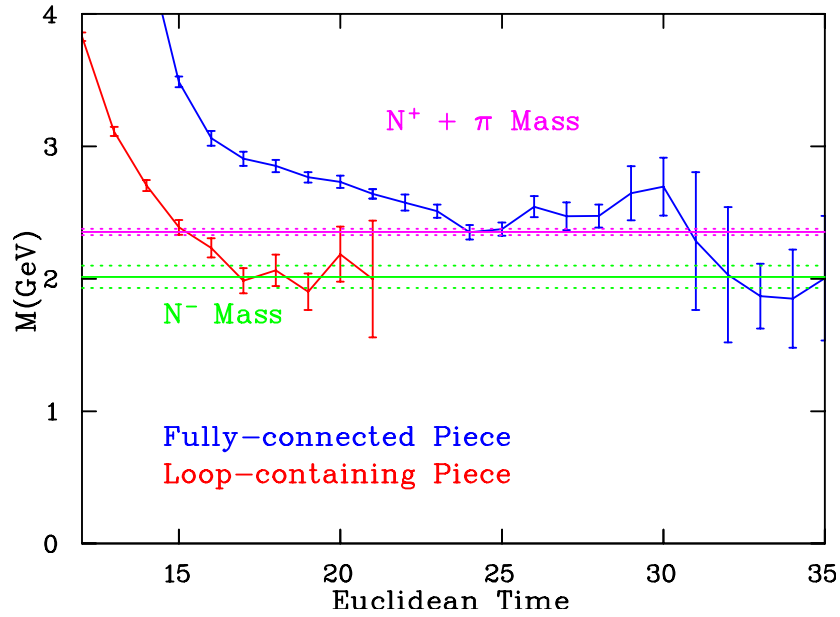

Figure 4.14: An effective mass plot comparing the loop-containing and fully-connected pieces of the five-quark proton.

As was the case for the even-parity proton, it is encouraging to note the fully-connected piece displaying overlap with a more massive state before decaying to the  $N + \pi$  mass. This suggests further correlation matrix studies will successfully extract more states. Once again we observe that the total five-quark operator displays good agreement with the mass extracted from the corresponding three-quark operator reinforcing the idea that the possibility of quark annihilation is vital to obtaining a low-lying mass. Similar to what we observed for the even-parity proton the loop-containing piece of the correlation function is also the dominant contribution to the five-quark operator mass. As was the case in the preceding section future studies with more statistics and lighter quark masses will be interesting.

### 4.3 The Even-Parity $\Delta^{++}$

We now present the relevant plots for the even-parity spin- $\frac{1}{2}$   $\Delta^{++}$ . We also make use of the nucleon and pion results with one unit of momentum presented in the preceding section.

#### 4.3.1 Correlation Functions

We begin by examining the relevant correlation function plots.

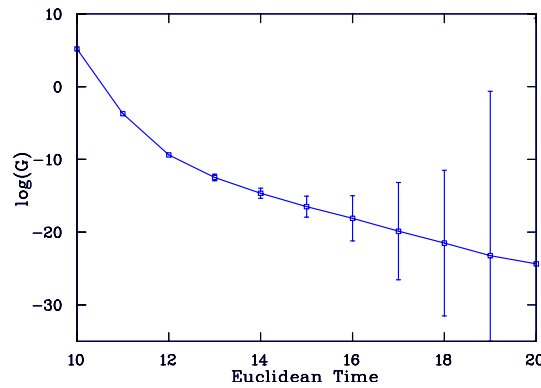

Figure 4.15: A correlation function plot for the five-quark  $\Delta^{++}$  interpolator.

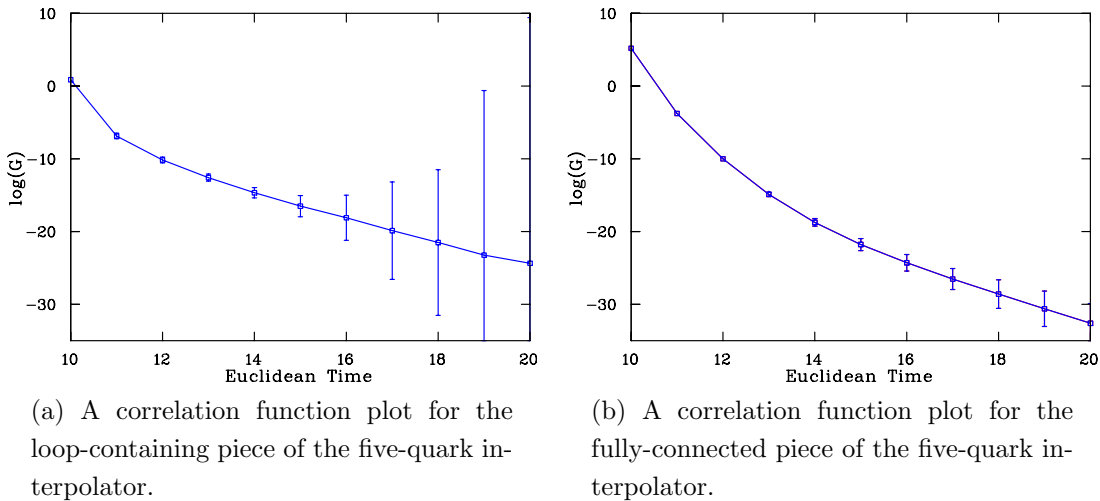

Figure 4.16: Correlation function plots for the loop-containing and fully-connected pieces of the five-quark  $\Delta^{++}$ .

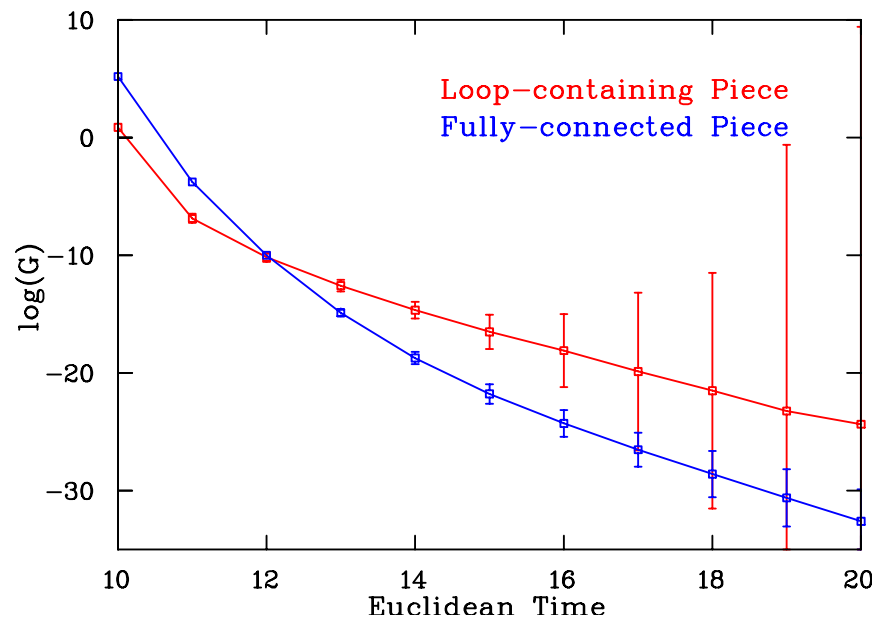

Figure 4.17: A comparison of the loop-containing and fully-connected pieces of the five-quark  $\Delta^{++}$  correlation functions.

### 4.3.2 Effective Mass Plots

Here we present a first look at the results for the spin- $\frac{1}{2}$   $\Delta^{++}$  baryon corresponding to the correlators calculated in the previous section.

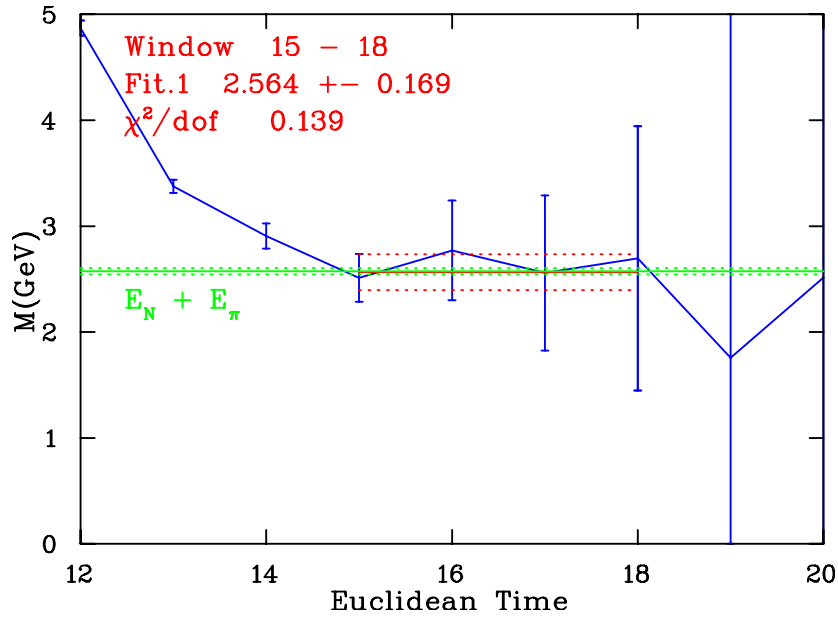

Figure 4.18: An effective mass plot for the five-quark  $\Delta^{++}$  operator.

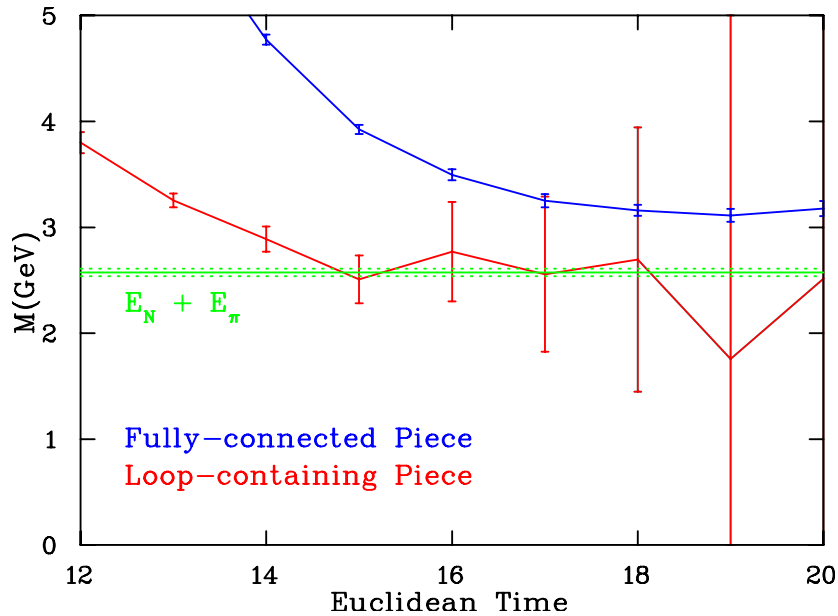

Figure 4.19: An effective mass plot comparing the loop-containing and fully-connected pieces of the five-quark  $\Delta^{++}$ .

The lowest-lying  $\Delta$  baryon state with  $I(J^P) = \frac{3}{2}(\frac{1}{2}^+)$  in Nature is the one star status resonance at 1750 MeV. This five-quark operator is therefore a good candidate to reveal a lowest-lying state that is consistent with a multi-particle state. As expected we observe consistency with the  $E_N + E_\pi$  threshold. Due to the massive nature of the state, the results produced from the five-quark operator are expected to be statistically challenging which is indeed what we observe. Future work with more statistics as discussed in the preceding section will assist in extracting masses with a higher level of precision.

As was the case with the proton in the preceding section, the loop-containing piece of the correlation function is the dominant contribution to the total five-quark operator mass. The fully-connected piece of the correlator once again has higher overlap with more massive states, providing optimism that the extraction of a higher number of states via correlation matrix techniques will be successful.

It is interesting how the low-lying two-particle state is dominated by the loop-annihilation containing piece of the correlation function. Quark loops implicit in the gauge fields and loops associated with various time orderings of the valence propagators are sufficient to describe these low-lying multi-particle states. Indeed, one can anticipate that a similar calculation with a spin -  $1/2$  projected three-quark  $\Delta^{++}$  interpolator would produce a similar result.

## 4.4 The Odd-Parity $\Delta^{++}$

### 4.4.1 Correlation Functions

We now present the correlation function plots for the odd-parity spin- $\frac{1}{2}$   $\Delta^{++}$ .

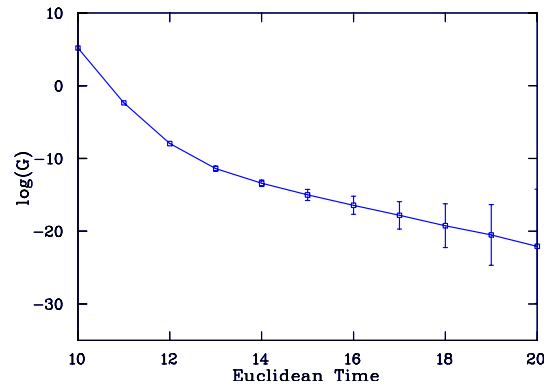
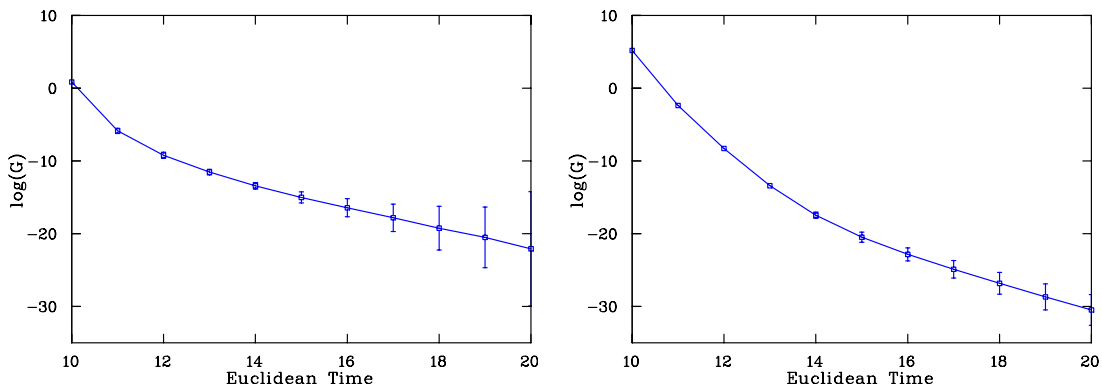

Figure 4.20: A correlation function plot for the five-quark  $\Delta^{++}$  interpolator.



(a) A correlation function plot for the loop-containing piece of the five-quark interpolator.

(b) A correlation function plot for the fully-connected piece of the five-quark interpolator.

Figure 4.21: Correlation function plots for the loop-containing and fully-connected pieces of the five-quark  $\Delta^{++}$ .



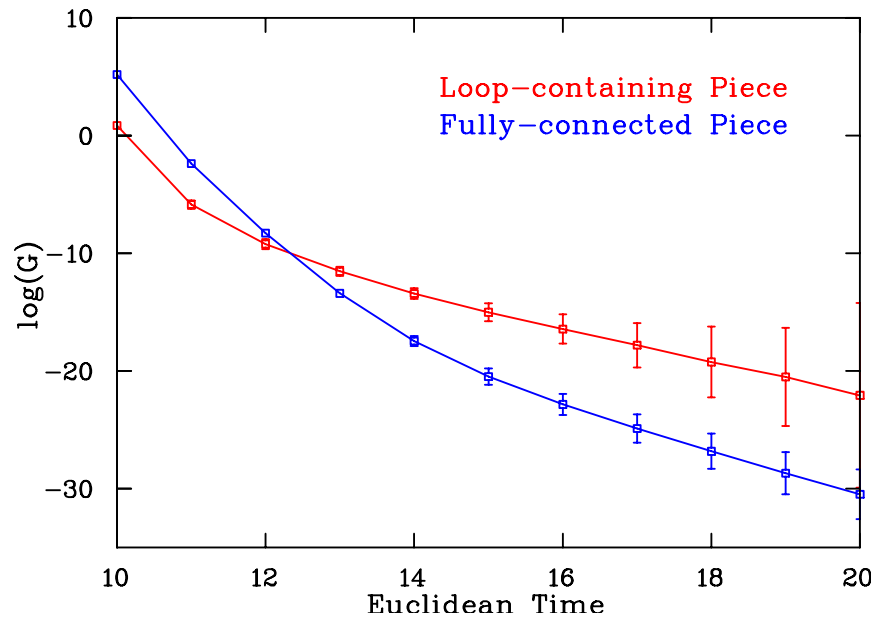

Figure 4.22: A comparison of the loop-containing and fully-connected pieces of the five-quark  $\Delta^{++}$  correlation functions.

### 4.4.2 Effective Mass Plots

Here we present the effective mass plots corresponding to the odd-parity spin- $\frac{1}{2}$   $\Delta^{++}$  correlators in the preceding section.

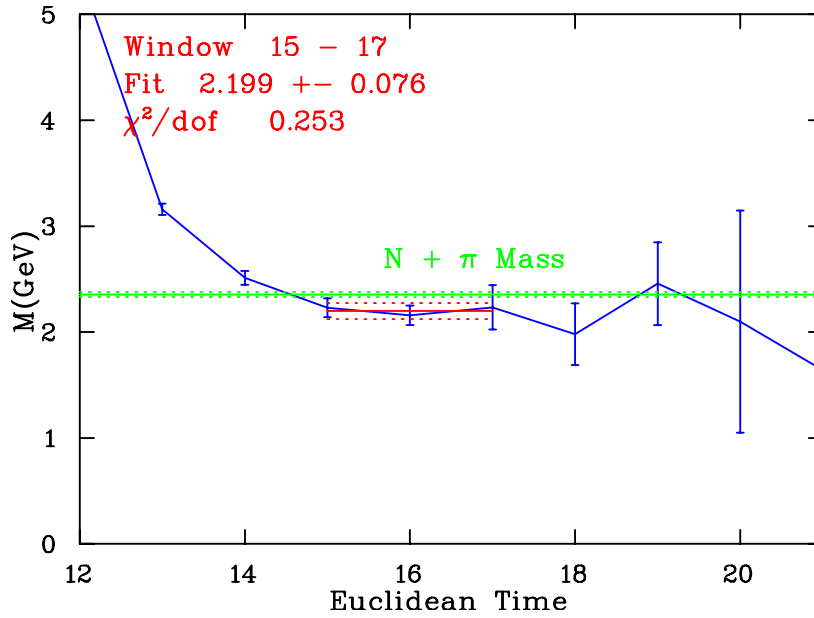

Figure 4.23: An effective mass plot for the five-quark  $\Delta^{++}$  operator.

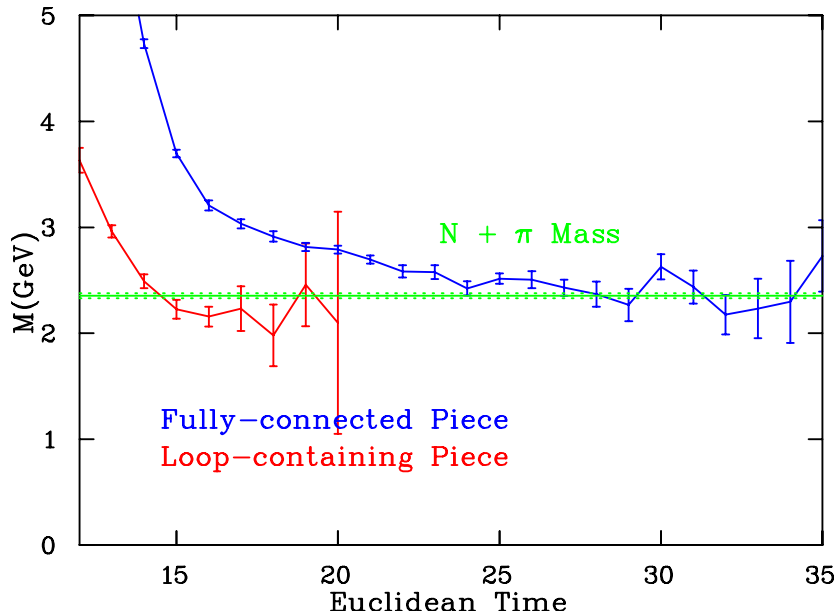

Figure 4.24: An effective mass plot comparing the loop-containing and fully-connected pieces of the five-quark  $\Delta^{++}$ .

In Nature the lowest-lying resonance of the  $\Delta$  baryon with  $I(J^P) = \frac{3}{2}(\frac{1}{2}^-)$  is at 1620 MeV, and possesses a four star status. However, we anticipate the two-particle  $N\pi$  state will dominate the correlator at large Euclidean times. The intrinsic parity of the pion places the odd-parity two-particle threshold at  $M_N + M_\pi$ . As expected the odd-parity state is less statistically demanding and lies below the even-parity state. We observe the mass extracted from the five-quark operator to lie below the  $N + \pi$  mass, which is not unexpected due to the nucleon-pion attractive interaction in a finite volume box.

Once again the loop-containing piece is the dominant contribution to the total five-quark operator correlation function, while the fully-connected piece displays overlap with more massive states. The fully-connected piece is particularly interesting, as while clearly exhibiting overlap with more massive states, it eventually shows consistency with the  $N + \pi$  threshold, suggesting it possesses a rich structure useful in future correlation matrix studies.

## 4.5 The Odd-parity $\Lambda$

The underlying composition of the 1405 MeV resonance of the  $\Lambda$  baryon has puzzled researchers for many years. Further discussion of lattice results for this resonance can be found in reference [20]. It is the lowest-lying excited state of the  $\Lambda$ , and it possesses negative parity. Moreover, it lies lower than the lowest negative-parity state of the nucleon, even though it contains a valence strange quark. The internal structure of this resonance has remained a mystery for many years. On one hand, it is regarded as a conventional three-quark state, while on the other it is interpreted as an anti-kaon/nucleon bound state.

Here we present results for the five-quark negative parity  $\Lambda$ . Recall that all plots are presented at the  $SU(3)$  flavour limit. The kaon mass is therefore identical to the pion mass, and the octet  $\Lambda$  correlator is identical to the nucleon correlator (see Appendix F), although of course we extract the mass from different components as we are studying different parity states.

### 4.5.1 Correlation Functions

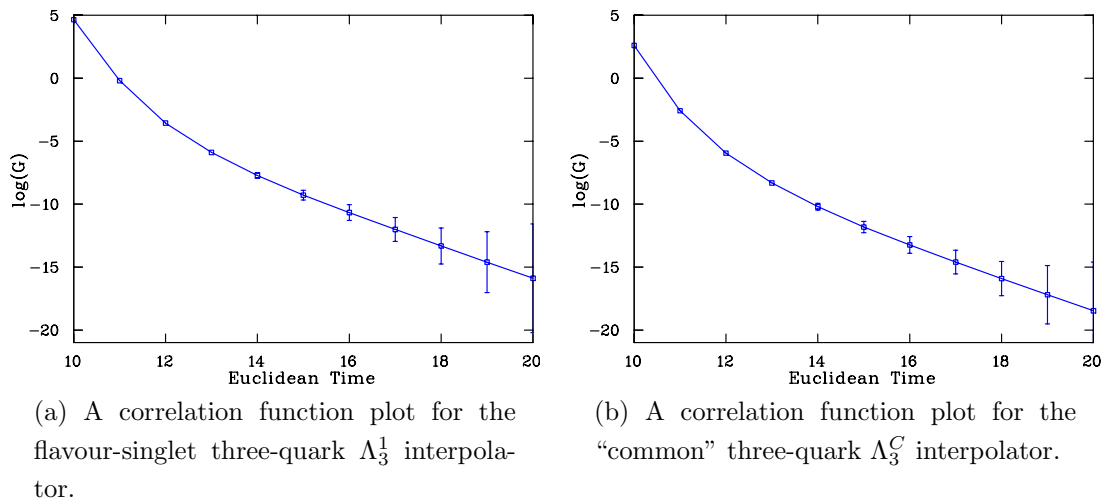

Figure 4.25: Effective mass plots for the flavour-singlet and "common" three-quark  $\Lambda$  interpolators.

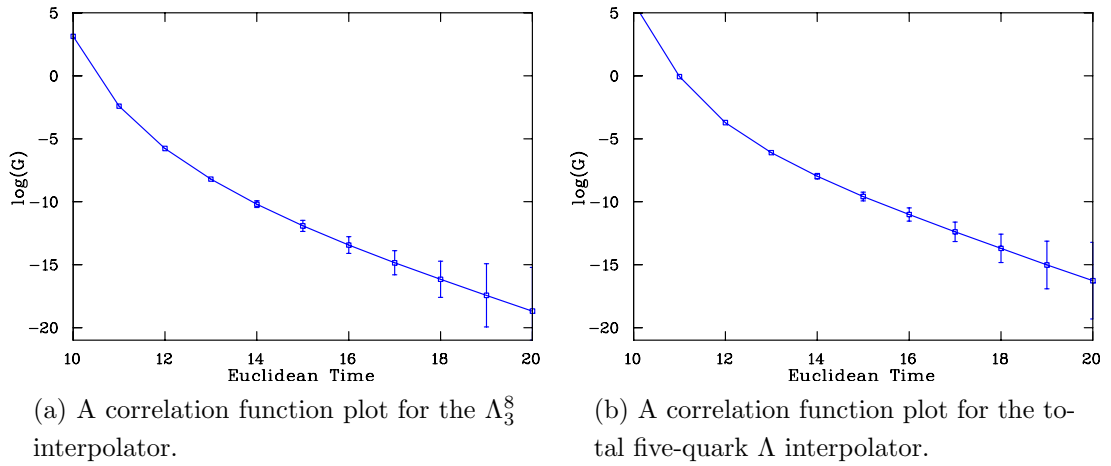

Figure 4.26: Correlation function plots of the three-quark octet interpolator and five-quark operator for the  $\Lambda$ .

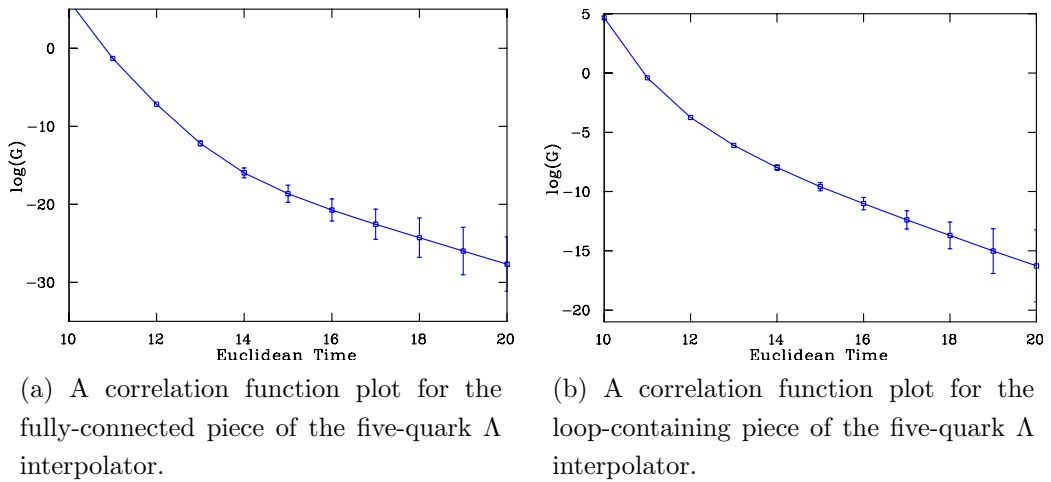

Figure 4.27: Plots of the loop-containing and fully-connected pieces for the five-quark operator  $\Lambda$ .

We observe that the loop-containing piece of the five-quark  $\Lambda$  operator in Figure 4.27 (b) is virtually indistinguishable from the total five-quark operator correlation function in (b) of Figure 4.26, indicating that this piece is the dominant contribution.

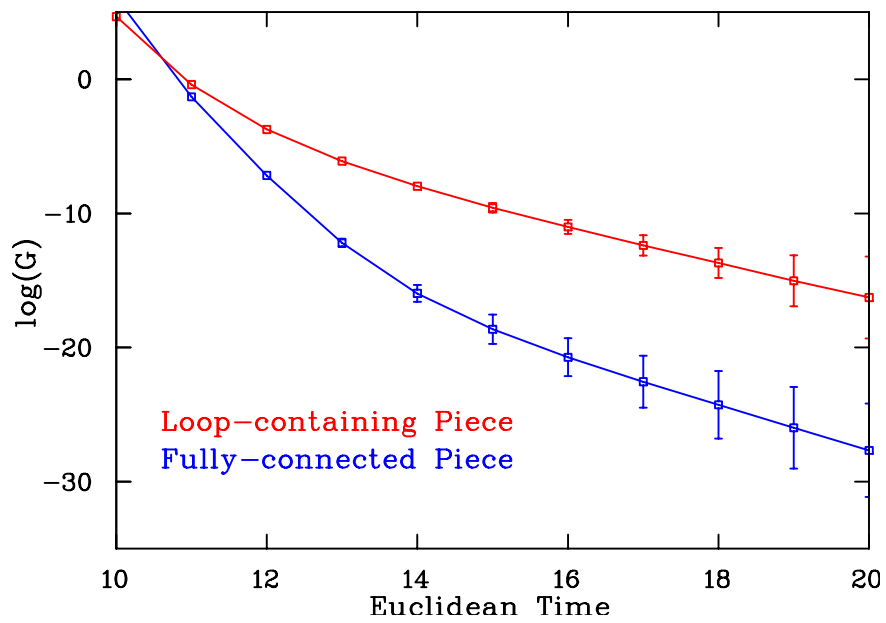
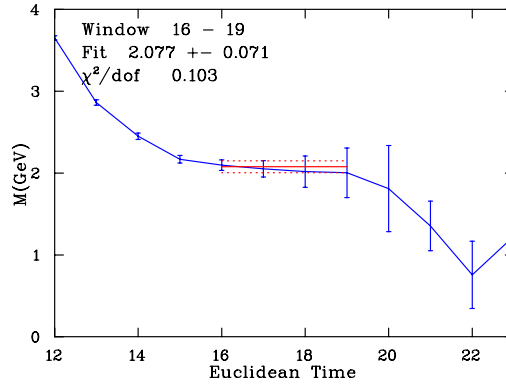
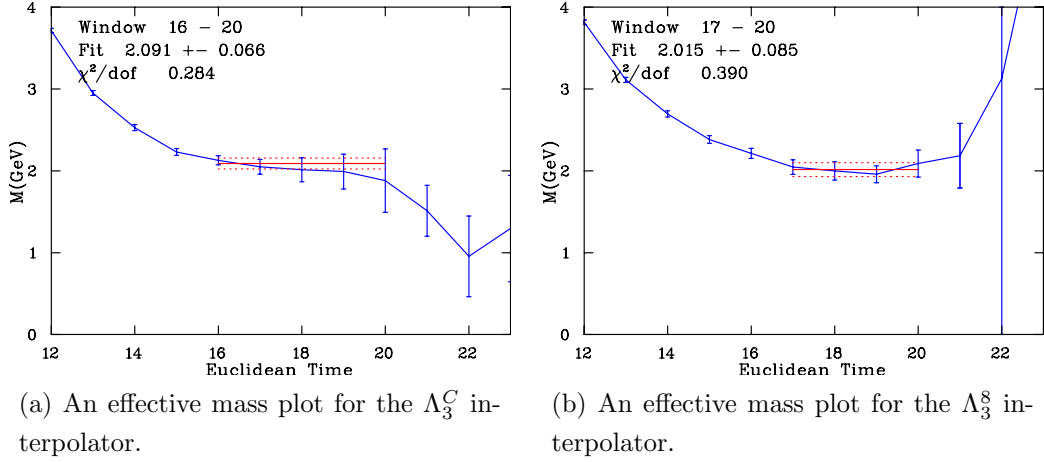

Figure 4.28: A comparison of the fully-connected and loop-containing pieces of the five-quark  $\Lambda$  interpolator. As was the case with the proton and  $\Delta^{++}$ , we observe the fully-connected piece possessing a steeper slope and therefore is associated with more massive parts of the spectrum.

### 4.5.2 Effective Mass Plots

We now present effective mass plots corresponding to the correlation functions in the preceding section.



(c) An effective mass plot for the  $\Lambda_3^1$  interpolator.

Figure 4.29: Effective Mass plots for various three-quark  $\Lambda$  interpolators.

We note that the error bars for the fits overlap for all three  $\Lambda$  interpolators shown in Figure 4.29. At this precision we are unable to isolate the various masses. Therefore, we use the mass extracted from the  $\Lambda^1$  interpolating field when making a comparison with the corresponding five-quark operator. We do however note here that the lowest lying odd-parity state of the  $\Lambda$  is predominately flavour-singlet [9].

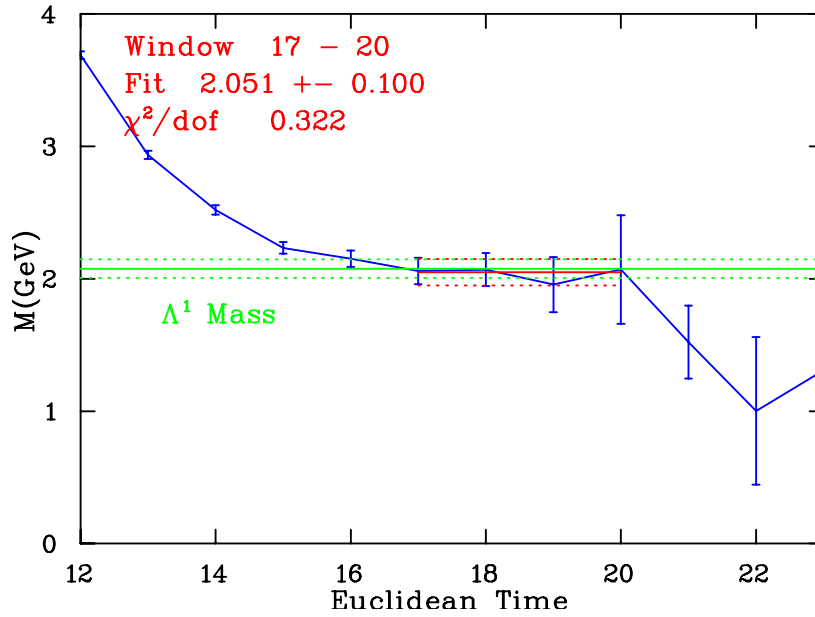

Figure 4.30: An effective mass plot for the five-quark  $\Lambda$  interpolator.

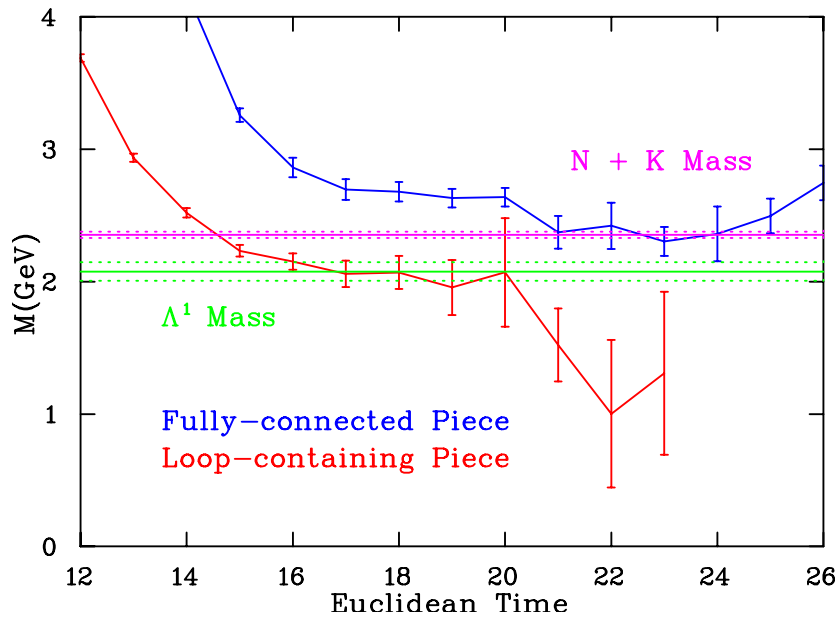

Figure 4.31: A comparison of the fully-connected and loop-containing pieces of the five-quark  $\Lambda$  interpolator. The nucleon mass is presented in Section 4.1. (Recall that as we are at the  $SU(3)$  flavour limit the kaon is identical to the pion - see Appendix F.)



As was the case for the proton, we again observe a reproduction of the three-quark operator  $\Lambda_3$  mass, with the total five-quark operator  $\Lambda_5$  (at the  $SU(3)$  flavour limit). As was the case with the proton and  $\Delta^{++}$ , the total correlation function is almost indistinguishable from the loop containing piece, once again indicating that the possibility of quark annihilation is vital to obtaining a low-lying mass from the five-quark operator.

Furthermore, we also observe the fully-connected piece displaying overlap with higher energy states, before dropping to the level of the  $N + K$  mass. This is particularly encouraging for future correlation matrix studies. These results should be viewed as an encouraging first step toward studies with higher precision and the pure flavour singlet five-quark interpolator whose correlation function is given in Appendix F. It would also be of interest to move away from the  $SU(3)$  flavour limit, and simulate at lighter quark masses to see if (and how) the contributions from the different pieces of the correlator are altered.



# Chapter 5

## Conclusion

The calculation of hadron masses is of general fundamental importance to our understanding of the world around us. In this work we have presented results from spectroscopic calculations using the only known non-perturbative *ab-initio* approach to working with QCD, that of lattice QCD. We have provided an important first step towards future correlation matrix studies with five-quark interpolating fields which will enable the extraction of multi-particle masses in their own right.

With this ultimate goal in mind we have constructed five-quark operators, that we naturally expect to have higher overlap with these more exotic states. The corresponding correlation functions that turned out to contain a considerable number of terms was then presented. As these correlation functions possess loop-containing diagrams, we then employed stochastic estimation techniques in order to calculate the corresponding loop propagators. In particular, we showed that a stochastic estimate of the point-to-all propagator yields encouraging results in the case of the pion.

We then presented mass plots extracted from our five-quark interpolators, and have seen that these interpolating fields show good agreement with the mass extracted from the three-quark operators in the case of the proton and the  $\Lambda$ . We further observed the fully-connected terms of the correlation functions having good overlap with more massive excited states. In the case of the proton and the  $\Lambda$ , these fully-connected pieces eventually ended up being consistent with the  $E_N + E_\pi$ ,  $M_N + M_\pi$  and  $M_N + M_K$  levels for the even-parity proton, odd-parity  $N^*$  and odd-parity  $\Lambda$  respectively. While one cannot take these fully-connected terms of the correlation function on their own in a rigorous manner, the results are promising for future correlation matrix analysis.

In the case of  $\Delta^{++}$  baryon, the interpolating field was constructed in order to give access to  $I(J^P) = \frac{3}{2}(\frac{1}{2}^{\pm})$  states, of which the lowest-lying resonances in Nature are at 1620MeV (odd-parity)<sup>1</sup> and 1750MeV (even-parity)<sup>2</sup>. The idea was to consider quantum numbers where the lowest-lying states would be two-particle scattering states. In the odd-parity case we observed the mass lying just below the  $M_N + M_\pi$  threshold which we noted was expected given the attraction felt by the nucleon and pion in finite volume. The more massive even-parity state was found to be statistically challenging which was expected. The two-particle threshold of  $E_N + E_\pi$  was observed.

In all cases the total correlation function was almost completely dominated by the loop-containing piece for the lowest-lying states examined herein, indicating the importance of the possibility of quark annihilation in obtaining a low-lying mass from a five-quark operator.

Further work will include calculating correlation functions with three-quark creation operators to five-quark annihilation operators, and visa versa. This will enable a correlation matrix analysis to be performed, enabling the extraction of multi-particle states in their own right. Furthermore, with the CSSM in the process of obtaining significant GPU computing power, more inversions will be possible, allowing us to simulate at lighter masses, larger volumes and average over more gauge configurations. In addition, the use of more advanced stochastic estimation techniques as mentioned in Chapter 3, could be employed in light of these extra resources.

On a final note, fully automated code to produce the evaluated two-point correlation function from arbitrary interpolators will be completed shortly. As such, any spectroscopic calculation with interpolating fields of considerable size (for example  $\pi\Sigma$ -type interpolators for the  $\Lambda$ ) would constitute a natural extension.

---

<sup>1</sup>As discussed previously this state possesses a four star status.

<sup>2</sup>As discussed previously this state possesses a one star status.

# Appendix A

## The Gell-Mann Matrices

The Gell-Mann complex  $3 \times 3$  matrices are a representation of the generators of  $SU(3)$ . As  $SU(3)$  has dimension 8, there are eight generators which satisfy the commutation relation

$$[\lambda_i, \lambda_j] = if^{ijk}\lambda_k, \quad (\text{A.1})$$

where the structure constants  $f^{ijk}$  are anti-symmetric in  $i, j$  and  $k$ . The most commonly used group representation is the particular choice of fundamental representation given by

$$\lambda_1 = \begin{bmatrix} 0 & 1 & 0 \\ 1 & 0 & 0 \\ 0 & 0 & 0 \end{bmatrix} \quad \lambda_2 = \begin{bmatrix} 0 & -i & 0 \\ i & 0 & 0 \\ 0 & 0 & 0 \end{bmatrix} \quad \lambda_3 = \begin{bmatrix} 1 & 0 & 0 \\ 0 & -1 & 0 \\ 0 & 0 & 0 \end{bmatrix}$$

$$\lambda_4 = \begin{bmatrix} 0 & 0 & 1 \\ 0 & 0 & 0 \\ 1 & 0 & 0 \end{bmatrix} \quad \lambda_5 = \begin{bmatrix} 0 & 0 & -i \\ 0 & 0 & 0 \\ i & 0 & 0 \end{bmatrix} \quad \lambda_6 = \begin{bmatrix} 0 & 0 & 0 \\ 0 & 0 & 1 \\ 0 & 1 & 0 \end{bmatrix}$$

$$\lambda_7 = \begin{bmatrix} 0 & 0 & 0 \\ 0 & 0 & -i \\ 0 & i & 0 \end{bmatrix} \quad \lambda_8 = \frac{1}{\sqrt{3}} \begin{bmatrix} 1 & 0 & 0 \\ 0 & 1 & 0 \\ 0 & 0 & -2 \end{bmatrix}.$$



# Appendix B

## $\gamma$ -Matrices

Here we present two different representations of the  $\gamma$ -matrices, and some useful algebraic properties that were helpful in the calculation of our simplified two-point functions in (3.29), (3.30) and (3.31).

### B.1 Dirac Representation

The Dirac representation used in Bjorken and Drell for example [64], is the usual representation used for algebraic manipulation, with a defining relation

$$\{\gamma_\mu, \gamma_\nu\} = 2g_{\mu\nu}, \quad \text{for } \mu, \nu = 0, 1, 2, 3 \quad (\text{B.1})$$

where the metric  $g_{\mu\nu}$  is given by

$$g_{\mu\nu} = \begin{bmatrix} 1 & 0 & 0 & 0 \\ 0 & -1 & 0 & 0 \\ 0 & 0 & -1 & 0 \\ 0 & 0 & 0 & -1 \end{bmatrix}. \quad (\text{B.2})$$

The  $\gamma$ -matrices can then written

$$\gamma_0 = \begin{bmatrix} I & 0 \\ 0 & -I \end{bmatrix} \quad \gamma_i = \begin{bmatrix} 0 & \sigma_i \\ -\sigma_i & 0 \end{bmatrix}, \quad (\text{B.3})$$

where  $\sigma_i$  are the  $2 \times 2$  complex, unitary, Hermitian Pauli matrices given by

$$\sigma_1 = \begin{bmatrix} 0 & 1 \\ 1 & 0 \end{bmatrix} \quad \sigma_2 = \begin{bmatrix} 0 & -i \\ i & 0 \end{bmatrix} \quad \sigma_3 = \begin{bmatrix} 1 & 0 \\ 0 & -1 \end{bmatrix}. \quad (\text{B.4})$$

We also define a  $\gamma_5$  matrix to be

$$\begin{aligned}\gamma_5 &= -\frac{i}{24}\epsilon^{\alpha\beta\delta\eta}\gamma_\alpha\gamma_\beta\gamma_\delta\gamma_\eta = i\gamma_0\gamma_1\gamma_2\gamma_3 \\ &= \begin{bmatrix} 0 & 0 & 1 & 0 \\ 0 & 0 & 0 & 1 \\ 1 & 0 & 0 & 0 \\ 0 & 1 & 0 & 0 \end{bmatrix}.\end{aligned}\tag{B.5}$$

In this representation some useful properties are

- $\gamma_0^2 = I$
- $\gamma_5^2 = I$
- $\gamma_0^\dagger = \gamma_0$
- $\gamma_5^\dagger = \gamma_5$
- $\gamma_\mu^\dagger = -\gamma_\mu$
- $\gamma_0\gamma_\mu^\dagger\gamma_0 = \gamma_\mu$
- $\{\gamma_5, \gamma_\mu\} = 0$

In our two-point function calculation we have also used the charge conjugation matrix  $C$

$$C \equiv i\gamma_0\gamma_2,\tag{B.6}$$

which has the following useful properties

- $C^T = C^{-1} = C^\dagger = -C$
- $(C\gamma_5)^T = -C\gamma_5$
- $(C\gamma_\mu)^T = C\gamma_\mu$
- $\gamma_0 C^\dagger \gamma_0 = C$
- $\gamma_0 (C\gamma_\mu)^\dagger \gamma_0 = \gamma_\mu C$
- $\gamma_0 C\gamma_5\gamma_0 = C\gamma_5 = -\gamma_0 (C\gamma_5)^T \gamma_0$
- $-\gamma_\mu^T = C\gamma_\mu C^{-1} = C^\dagger \gamma_\mu C$



## B.2 Pauli Representation

On the lattice, it is often useful to deal with Hermitian matrices, and as such the Pauli representation used by Sakurai for example [83], is used on the lattice. The defining relation can be written

$$\{\gamma_\mu, \gamma_\nu\} = 2\delta_{\mu\nu}, \quad \text{for } \mu, \nu = 1, 2, 3, 4. \quad (\text{B.7})$$

In this representation the  $\gamma$ -matrices can be written

$$\gamma_i = \begin{bmatrix} 0 & -i\sigma_i \\ i\sigma_i & 0 \end{bmatrix} \quad \gamma_4 = \begin{bmatrix} I & 0 \\ 0 & -I \end{bmatrix}, \quad (\text{B.8})$$

and  $\gamma_5$  is defined

$$\begin{aligned} \gamma_5 &= \frac{1}{24} \epsilon^{\alpha\beta\delta\eta} \gamma_\alpha \gamma_\beta \gamma_\delta \gamma_\eta = \gamma_1 \gamma_2 \gamma_3 \gamma_4 \\ &= - \begin{bmatrix} 0 & I \\ I & 0 \end{bmatrix}. \end{aligned} \quad (\text{B.9})$$

In this representation some useful properties are

- $\gamma_\mu^2 = I$
- $\gamma_5^2 = I$
- $\gamma_\mu^\dagger = \gamma_\mu$
- $\gamma_5^\dagger = \gamma_5$
- $\{\gamma_5, \gamma_\mu\} = 0$ .

In the Sakurai representation

$$C \equiv \gamma_4 \gamma_2, \quad (\text{B.10})$$

which is exactly the same as  $C$  in the Dirac representation. It has the useful properties

- $C^T = C^{-1} = C^\dagger = -C$
- $(C\gamma_5)^T = -C\gamma_5$
- $(C\gamma_\mu)^T = C\gamma_\mu$
- $(\gamma_\mu C)^T = \gamma_\mu C$
- $\gamma_0 (C\gamma_\mu)^\dagger \gamma_0 = \gamma_\mu C$
- $-\gamma_\mu^T = C\gamma_\mu C^{-1} = C^\dagger \gamma_\mu C$ .



# Appendix C

## Clebsch-Gordan Coefficients

The rules for combining states of a given isospin are the same as for spin, as they are mathematically equivalent. The Clebsch-Gordan coefficients<sup>1</sup> provide constants to enable us to decompose the direct product of two irreducible representations of the rotation group into a direct sum of irreducible representations. That is,

$$|I', I'_3\rangle |I'', I''_3\rangle = \sum_I C_{I'_3 I''_3 I_3}^{I' I'' I} |I, I_3\rangle, \quad (\text{C.1})$$

where  $C_{I'_3 I''_3 I_3}^{I' I'' I}$  are the Clebsch-Gordan coefficients and  $I$  is total isospin with isospin projection  $I_3$ . These coefficients can also be used to decompose a state into a linear combination of composite states,

$$|I, I_3\rangle = \sum_{I'_3=I_3-I''_3} C_{I'_3 I''_3 I_3}^{I' I'' I} |I', I'_3\rangle |I'', I''_3\rangle. \quad (\text{C.2})$$

In this work we make use of (C.2) with  $I' = 1/2, I'' = 1/2$ , and  $I = 1, I'' = 1/2$ , and hence we include the relevant table of coefficients.

<b>1/2 x 1/2</b>		1				
		+1	1	0		
+1/2	+1/2	1	0	0		
	+1/2	-1/2	1/2	1/2	1	
	-1/2	+1/2	1/2	-1/2	-1	
			-1/2	-1/2	1	

Figure C.1: *Clebsch-Gordan coefficients for the case  $I' = 1/2, I'' = 1/2$ .* Recall there is an implicit square root sign over the positive part of each table entry.

<sup>1</sup>See [84] for an introductory discussion to Clebsch-Gordan coefficients.

<b>1 x 1/2</b>		3/2						
		+ 3/2	3/2	1/2				
+ 1	+ 1/2	1	+ 1/2	+ 1/2				
	+ 1	- 1/2	1/3	2/3	3/2	1/2		
	0	+ 1/2	2/3	- 1/3	- 1/2	- 1/2		
			0	- 1/2	2/3	1/3	3/2	
			- 1	+ 1/2	1/3	- 2/3	- 3/2	
					- 1	- 1/2	1	

Figure C.2: Clebsch-Gordan coefficients for the case  $I' = 1, I'' = 1/2$ . Recall there is an implicit square root sign over the positive part of each table entry.

# Appendix D

## Wick's Theorem

When calculating correlation functions, we need to calculate vacuum expectation values of time-ordered products of free field operators. That is, we need to evaluate expressions of the form:

$$\langle 0 | T \{ \phi_I(x_1) \phi_I(x_2) \dots \phi_I(x_n) \} | 0 \rangle \quad (\text{D.1})$$

where  $\phi_I$  denotes the interaction picture field, which can be written explicitly as:

$$\phi_I(t, \mathbf{x}) = \int \frac{d^3 p}{(2\pi)^3} \frac{1}{\sqrt{2E_{\mathbf{p}}}} \left( a_{\mathbf{p}} e^{-ip \cdot x} + a_{\mathbf{p}}^\dagger e^{ip \cdot x} \right) \Big|_{x^0=t-t_0}. \quad (\text{D.2})$$

In order to calculate expressions of the form in equation D.1, we could of course substitute in D.2 and chug away with brute force. However, there is a much simpler way to calculate these expressions, which we can see by considering a form that is easily generalized<sup>1</sup>. First we note that we can make a decomposition of  $\phi_I(x)$ , into positive and negative frequency components, that is

$$\phi_I(x) = \phi_I^+(x) + \phi_I^-(x), \quad (\text{D.3})$$

where

$$\phi_I^+(x) = \int \frac{d^3 p}{(2\pi)^3} \frac{1}{\sqrt{2E_{\mathbf{p}}}} a_{\mathbf{p}} e^{-ip \cdot x}; \quad \phi_I^-(x) = \int \frac{d^3 p}{(2\pi)^3} \frac{1}{\sqrt{2E_{\mathbf{p}}}} a_{\mathbf{p}}^\dagger e^{+ip \cdot x}. \quad (\text{D.4})$$

This decomposition is useful, as we can now exploit the fact that

$$\phi_I^+(x) | 0 \rangle = 0 \quad \text{and} \quad \langle 0 | \phi_I^-(x) = 0. \quad (\text{D.5})$$

Now we consider the case  $x_2^0 > x_1^0$ ,

---

<sup>1</sup>The outline of Wick's Theorem presented here essentially follows that given by Peskin and Schroeder [85].

$$\begin{aligned}
T\{\phi_I(x_1)\phi_I(x_2)\} &= \phi_I^+(x_2)\phi_I^+(x_1) + \phi_I^+(x_2)\phi_I^-(x_1) + \phi_I^-(x_2)\phi_I^+(x_1) \\
&\quad + \phi_I^-(x_2)\phi_I^-(x_1) \\
&= \phi_I^+(x_2)\phi_I^+(x_1) + \phi_I^-(x_1)\phi_I^+(x_2) + \phi_I^-(x_2)\phi_I^+(x_1) \\
&\quad + \phi_I^-(x_2)\phi_I^-(x_1) + [\phi_I^+(x_2), \phi_I^-(x_1)]. \tag{D.6}
\end{aligned}$$

and similarly for  $x_1^0 > x_2^0$ ,

$$\begin{aligned}
T\{\phi_I(x_1)\phi_I(x_2)\} &= \phi_I^+(x_1)\phi_I^+(x_2) + \phi_I^+(x_1)\phi_I^-(x_2) + \phi_I^-(x_1)\phi_I^+(x_2) \\
&\quad + \phi_I^-(x_1)\phi_I^-(x_2) \\
&= \phi_I^+(x_1)\phi_I^+(x_2) + \phi_I^-(x_2)\phi_I^+(x_1) + \phi_I^-(x_1)\phi_I^+(x_2) \\
&\quad + \phi_I^-(x_1)\phi_I^-(x_2) + [\phi_I^+(x_1), \phi_I^-(x_2)]. \tag{D.7}
\end{aligned}$$

We now note that all non-commutator terms are normal ordered, that is all  $a_{\mathbf{p}}$  are to the right of all  $a_{\mathbf{p}}^\dagger$ , and therefore by equations D.5 have zero vacuum expectation value. We will therefore find it convenient to define the contraction of two fields  $\phi_1 = \phi(x_1)$  and  $\phi_2 = \phi(x_2)$  as:

$$\overline{\phi_1\phi_2} = \begin{cases} [\phi_1^+, \phi_2^-] & \text{for } x_1^0 > x_2^0 \\ [\phi_2^+, \phi_1^-] & \text{for } x_2^0 > x_1^0 \end{cases} \tag{D.8}$$

where we have dropped the  $I$  subscript, as contractions always involve interaction picture fields. This definition still holds for non-adjacent fields. The time ordered product of two fields can now be written as:

$$T\{\phi_1\phi_2\} = :\phi_1\phi_2 + \overline{\phi_1\phi_2}:^2 \tag{D.9}$$

We can now generalize D.9 to arbitrarily many fields arriving at:

### Wick's Theorem.

$$T\{\phi_1\phi_2 \dots \phi_n\} = :\phi_1\phi_2 \dots \phi_n + \text{all possible contractions}: \tag{D.10}$$

*Proof.* Motivated by the equation form we do proof by induction. Suppose D.10 is true for  $n - 1$  fields. Now relabel our points such that  $x_1^0 \geq x_2^0 \geq \dots x_n^0$ , noting that D.10 is invariant under relabeling. Applying Wick's Theorem to the fields  $\phi_2 \dots \phi_n$  we obtain:

---

<sup>2</sup>Here we have adopted the convention of denoting the normal ordering of two fields  $\phi_1$  and  $\phi_2$  as  $:\phi_1\phi_2:$

$$\begin{aligned}
T\{\phi_1\phi_2\dots\phi_n\} &= \phi_1\phi_2\dots\phi_n \\
&= \phi_1:\phi_2\dots\phi_n + \text{all possible contractions without } \phi_1: \\
&= (\phi_1^+ + \phi_1^-):\phi_2\dots\phi_n + \text{all possible contractions without } \phi_1:
\end{aligned} \tag{D.11}$$

First we consider the term without any contractions:

$$\begin{aligned}
(\phi_1^+ + \phi_1^-):\phi_2\dots\phi_n: &= \phi_1^+:\phi_2\dots\phi_n: + \phi_1^-:\phi_2\dots\phi_n: \\
&= \phi_1^+:\phi_2\dots\phi_n: + :\phi_1^-\phi_2\dots\phi_n:
\end{aligned}$$

The  $\phi_1^+$  cannot be moved inside the normal ordering as its not normal ordered like  $\phi_1^-$ , so we put it in normal order by commuting it with the other  $\phi$ .

$$\begin{aligned}
\phi_1^+:\phi_2\dots\phi_n: &= [\phi_1^+, :\phi_2\dots\phi_n:] + :\phi_2\dots\phi_n:\phi_1^+ \\
&= :\phi_1^+\phi_2\dots\phi_n: + :[\phi_1^+, \phi_2^-]\phi_3\dots\phi_n + \phi_2[\phi_1^+, \phi_3^-]\phi_4\dots\phi_n + \dots: \\
&= :\phi_1^+\phi_2\dots\phi_n: + \overline{\phi_1\phi_2}\phi_3\dots\phi_n + \overline{\phi_1\phi_2\phi_3}\dots\phi_n + \dots:
\end{aligned} \tag{D.12}$$

So now we have all possible terms with a single contraction of  $\phi_1$  with another field together with  $:\phi_1\phi_2\phi_3\dots\phi_n:$  which comes from part of the  $\phi_1^-$  term from (D.11) combining with the first term in (D.12). Similarly, replicating the procedure for terms in (D.11) with a single contraction yields all possible terms with both that contraction and the contraction of  $\phi_1$  with one of the other fields. Performing this procedure for all the terms present in (D.11) will therefore produce all possible contractions of all the fields.  $\square$





# Appendix E

## Transformation Properties of Interpolating Fields

Here we outline the transformation properties of the interpolators given in Table 3.1. We first note that our requirement of the interpolators creating a colour singlet state is satisfied in the meson case by the sum over repeated colour indices, and in the baryon case by the Levi-Cevita tensor  $\epsilon^{abc}$ . The Levi-Cevita tensor also ensures gauge invariance. To see this we consider the local gauge transformation

$$\psi^a(x) \rightarrow G^{aa'}(x)\psi^{a'}(x). \quad (\text{E.1})$$

Our baryon interpolator will then transform as

$$\chi(x) \rightarrow G^{aa'}(x)G^{bb'}(x)G^{cc'}(x)\psi^{a'}(x)\psi^{b'}(x)\psi^{c'}(x)\dots, \quad (\text{E.2})$$

where we have suppressed Dirac indices for brevity. We can now see that

$$\begin{aligned} \epsilon^{abc}G^{aa'}(x)G^{bb'}(x)G^{cc'}(x) &= \epsilon^{a'b'c'} \det [G(x)] \\ &= \epsilon^{a'b'c'}, \end{aligned} \quad (\text{E.3})$$

as  $G(x) \in SU(3)$ . Hence we see that the presence of the Levi-Cevita tensor ensures the gauge invariance of our baryon interpolators which take the form

$$\chi(x) = \epsilon^{abc}\psi_\alpha^a\psi_\beta^b\psi_\gamma^c\dots \quad (\text{E.4})$$

Of course our meson interpolators are clearly gauge invariant as

$$\psi(x) \rightarrow G(x)\psi(x), \quad \bar{\psi}(x) \rightarrow \bar{\psi}(x)G^\dagger(x) \quad (\text{E.5})$$

ensures any interpolator of the form

$$\chi(x) = \bar{\psi}_\alpha^a(x)\psi_\beta^a(x) \quad (\text{E.6})$$

is automatically gauge invariant as  $G(x) \in SU(3)$  is unitary.

## E.1 Lorentz Transformations

We know that quarks being spin 1/2 particles transform as

$$\psi_\alpha^a \rightarrow S(\Lambda)_{\alpha\alpha'} \psi_{\alpha'}^a(\Lambda x), \quad (\text{E.7})$$

where

$$S(\Lambda) = e^{-i\omega_{\mu\nu}\sigma^{\mu\nu}}. \quad (\text{E.8})$$

Similarly,

$$\bar{\psi}_\alpha^a \rightarrow \bar{\psi}_{\alpha'}^a(\Lambda x) S(\Lambda)_{\alpha'\alpha}^{-1}. \quad (\text{E.9})$$

### E.1.1 Meson Interpolators

Using the transformation properties in (E.7) and (E.9), we see that the meson interpolators we've used which are of the form  $\bar{\psi}_\alpha^a(x) \gamma_5 \psi_\beta^a(x)$ , transform as

$$\chi(x) \rightarrow \bar{\psi}_{\alpha'}^a(\Lambda x) S(\Lambda)_{\alpha'\alpha}^{-1} (\gamma_5)_{\alpha\beta} S(\Lambda)_{\beta\beta'} \psi_{\beta'}^a(\Lambda x). \quad (\text{E.10})$$

Then using the properties

$$\gamma_5 S(\Lambda)^{-1} \gamma_5 = e^{i\omega_{\mu\nu}(\gamma_5 \sigma^{\mu\nu} \gamma_5)} \quad \text{and} \quad \gamma_5 \sigma^{\mu\nu} \gamma_5 = \sigma^{\mu\nu}, \quad (\text{E.11})$$

we can see that

$$\begin{aligned} S(\Lambda)^{-1} \gamma_5 S(\Lambda) &= e^{i\omega_{\mu\nu}\sigma^{\mu\nu}} \gamma_5 e^{-i\omega_{\mu\nu}\sigma^{\mu\nu}} = \gamma_5^2 e^{i\omega_{\mu\nu}\sigma^{\mu\nu}} \gamma_5 e^{-i\omega_{\mu\nu}\sigma^{\mu\nu}} \\ &= \gamma_5 e^{i\omega_{\mu\nu}(\gamma_5 \sigma^{\mu\nu} \gamma_5)} e^{-i\omega_{\mu\nu}\sigma^{\mu\nu}} \\ &= \gamma_5 S(\Lambda)^{-1} S(\Lambda) \\ &= \gamma_5. \end{aligned} \quad (\text{E.12})$$

and hence our meson interpolators transform as a scalar under Lorentz transformations. That is,

$$\chi(x) \rightarrow \bar{\psi}_\alpha^a(x) (\gamma_5)_{\alpha\beta} \psi_\beta^a(x). \quad (\text{E.13})$$

### E.1.2 Baryon Interpolators

We now perform a similar analysis for the terms of our Baryon interpolators  $\chi_\eta(x)$  that are of the general form

$$\chi_\eta(x) = \epsilon^{abc} [\psi_\alpha^{aT}(x) (\Gamma_1)_{\alpha\beta} \psi_\beta^b(x)] (\Gamma_2)_{\eta\delta} \psi_\delta^c(x). \quad (\text{E.14})$$

Under the Lorentz transformation (E.7), the baryon interpolator (E.14) transforms as

$$\chi_\eta(x) \rightarrow \epsilon^{abc} [\psi_{\alpha'}^a S(\Lambda)_{\alpha\alpha'} (\Gamma_1)_{\alpha\beta} S(\Lambda)_{\beta\beta'} \psi_{\beta'}^b] (\Gamma_2)_{\eta\delta} S(\Lambda)_{\delta\delta'} \psi_{\delta'}^c, \quad (\text{E.15})$$

where we have suppressed space-time indices for clarity, and are aiming to constrain the interpolator to be Lorentz covariant. We first turn our attention to the term in the square brackets, the Dirac scalar. Here we have the term  $(S^T \Gamma_1 S)_{\alpha'\beta'}$ . We then observe that

$$\begin{aligned} S^T C &= C C^{-1} e^{-i\omega_{\mu\nu} \sigma^{\mu\nu T}} C \\ &= C C^T (1 - i\omega_{\mu\nu} \sigma^{\mu\nu T} + (-i\omega_{\mu\nu} \sigma^{\mu\nu T})^2 + \dots) C \\ &= C e^{-i\omega_{\mu\nu} C \sigma^{\mu\nu T} C^T} \\ &= C^{i\omega_{\mu\nu} \sigma^{\mu\nu}} \\ &= C S^{-1}, \end{aligned} \quad (\text{E.16})$$

where we have used properties of the charge conjugation matrix  $C$  from Appendix B, and

$$C \sigma^{\mu\nu T} C^T = -\sigma^{\mu\nu}. \quad (\text{E.17})$$

Then using (E.12) together with

$$S(\Lambda)^{-1} \gamma_\mu S(\Lambda) = \Lambda^\nu{}_\mu \gamma_\nu, \quad (\text{E.18})$$

we can see that we want  $\Gamma_1 \rightarrow C \Gamma_1$ , where  $\Gamma_1$  can be  $I, \gamma_5$  or in the case of spin 3/2 baryons  $\gamma_\mu$ . We also note in (E.15) that as

$$[\gamma_5, S] = 0, \quad (\text{E.19})$$

(which can be shown using  $\{\gamma_5, \gamma_\mu\} = 0$  from Appendix B), we can pull  $S(\Lambda)_{\delta\delta'}$  to the front if  $\Gamma_2 = \gamma_5$  (or of course  $I$ ). It is therefore sufficient to use  $\Gamma_2 = \gamma_5$  or  $I$ . We can now consider explicitly the Lorentz transformation on our interpolators. For the octet baryon interpolator terms

$$\chi_\eta(x) \rightarrow \frac{1}{\sqrt{2}} \epsilon^{abc} [\psi_{\alpha'}^a(\Lambda x) S(\Lambda)_{\alpha\alpha'} (C \gamma_5)_{\alpha\beta} S(\Lambda)_{\beta\beta'} \psi_{\beta'}^a(\Lambda x)] S(\Lambda)_{\eta\eta'} \psi_{\eta'}^a(\Lambda x). \quad (\text{E.20})$$

Then using (E.16) together with (E.19), we can see that

$$\begin{aligned} \chi_\eta(x) &\rightarrow \frac{1}{\sqrt{2}} \epsilon^{abc} [\psi_{\alpha'}^{aT}(\Lambda x) (C \gamma_5)_{\alpha\beta} \psi_{\beta'}^b(\Lambda x)] S(\Lambda)_{\eta\eta'} \psi_{\eta'}^c(\Lambda x) \\ &= S(\Lambda)_{\eta\eta'} \chi_{\eta'}(\Lambda x), \end{aligned} \quad (\text{E.21})$$

as the diquark in brackets is a Dirac scalar, and hence the octet baryon interpolators transform like spinors. Similarly, for the  $\Delta_3^{++}$  decuplet baryon interpolator we have

$$\begin{aligned}\chi_{\mu,\eta,3}^{\Delta^{++}} &\rightarrow \frac{1}{\sqrt{2}}\epsilon^{abc}[\psi_{\alpha'}^a(\Lambda x)S(\Lambda)_{\alpha\alpha'}(C\gamma_\mu)_{\alpha\beta}S(\Lambda)_{\beta\beta'}\psi_{\beta'}^b(\Lambda x)]S(\Lambda)_{\eta\eta'}\psi_{\eta'}^a(\Lambda x) \\ &= \frac{1}{\sqrt{2}}\Lambda^\nu{}_\mu\epsilon^{abc}[\psi_{\alpha'}^a(\Lambda x)(C\gamma_\nu)_{\alpha'\beta'}\psi_{\beta'}^b(\Lambda x)]S(\Lambda)_{\eta\eta'}\psi_{\eta'}^a(\Lambda x) \\ &= \Lambda^\nu{}_\mu S(\Lambda)_{\eta\eta'}\chi_{\nu,\eta',3}^{\Delta^{++}}\end{aligned}\tag{E.22}$$

where we have made use of (E.16) together with (E.18). Of course  $\Lambda^\nu{}_\mu$  is the Lorentz transformation for four-vectors, and therefore our  $\Delta_3^{++}$  interpolator transforms as a vector times a spinor under Lorentz transformations.

### E.1.3 Two-Particle Interpolators

We now repeat the above with our two-particle interpolators which have terms of the general form

$$\chi_\eta(x) = \frac{1}{\sqrt{2}}\epsilon^{abc}[\psi_{\alpha'}^{aT}(x)(C\gamma_5)_{\alpha\beta}\psi_{\beta'}^b(x)]\psi_\eta^c(x)[\bar{\psi}_\delta^e(x)(\gamma_5)_{\delta\rho}\psi_\rho^e(x)].\tag{E.23}$$

Under a Lorentz transformation  $\chi_\eta(x)$  then transforms as

$$\begin{aligned}\chi_\eta(x) &\rightarrow \frac{1}{\sqrt{2}}\epsilon^{abc}[\psi_{\alpha'}^a(\Lambda x)S(\Lambda)_{\alpha\alpha'}(C\gamma_5)_{\alpha\beta}S(\Lambda)_{\beta\beta'}\psi_{\beta'}^b(\Lambda x)]S(\Lambda)_{\eta\eta'}\psi_{\eta'}^a(\Lambda x) \\ &\quad \times [\bar{\psi}_{\delta'}^e(\Lambda x)S(\Lambda)_{\delta'\delta}^{-1}(\gamma_5)_{\delta\rho}S(\Lambda)_{\rho\rho'}\psi_{\rho'}^e(\Lambda x)] \\ &= S(\Lambda)_{\eta\eta'}\chi_{\eta'}(\Lambda x),\end{aligned}\tag{E.24}$$

where we have made use of (E.12), (E.16) and (E.19). The two-particle interpolators therefore transform as a spinor under Lorentz transformations.

## E.2 Parity

Under a parity transformation the quark fields  $\psi(x)$  transform as

$$\psi(x) \rightarrow \mathcal{P}\psi(x)\mathcal{P}^\dagger = \gamma_0\psi(\tilde{x}),\tag{E.25}$$

where  $\tilde{x} = (x_0, -\vec{x})$ . Similarly,

$$\bar{\psi}(x) \rightarrow \mathcal{P}\bar{\psi}(x)\mathcal{P}^\dagger = \bar{\psi}(\tilde{x})\gamma_0.\tag{E.26}$$

Applying these transformation rules to our meson interpolator  $\bar{\psi}(x)\gamma_5\psi(x)$  we obtain

$$\chi(x) \rightarrow \bar{\psi}(\tilde{x})\gamma_0\gamma_5\gamma_0\psi(\tilde{x}) = -\bar{\psi}(\tilde{x})\gamma_5\psi(\tilde{x}), \quad (\text{E.27})$$

as  $\{\gamma_5, \gamma_\mu\} = 0$  and of course  $\gamma_0^2 = I$  (see Appendix B). Our meson interpolator therefore transforms as a pseudo-scalar. Hence, as our meson interpolator transforms negatively under parity and as a scalar under a Lorentz transformation, it has the correct transformation properties for the  $J^P = 0^-$  states. Similarly, applying the transformation rules to our octet baryon interpolator terms  $\chi(x) = [\psi^T(x)(C\gamma_5)\psi(x)]\psi(x)$  used in Table 3.1 we find (suppressing colour and Dirac indices in addition to flavour for clarity)

$$\begin{aligned} \chi(x) &\rightarrow [(\gamma_0\psi)^T(\tilde{x})(C\gamma_5)\gamma_0\psi(\tilde{x})]\gamma_0\psi(\tilde{x}) \\ &= [\psi^T(\tilde{x})(C\gamma_5)\psi(\tilde{x})]\gamma_0\psi(\tilde{x}), \end{aligned} \quad (\text{E.28})$$

as  $\gamma_0C\gamma_5\gamma_0 = C\gamma_5$  (once again see Appendix B). However, our decuplet  $\Delta_{\mu,3}^{++}$  interpolator contains a Lorentz index. Therefore we consider,

$$\chi_3^{\Delta_{\mu,3}^{++}} \rightarrow \frac{1}{\sqrt{2}}\epsilon^{abc}(\psi^{Ta}(\tilde{x})\gamma_0C\gamma_\mu\gamma_0\psi^b(\tilde{x}))\gamma_0\psi^c(\tilde{x}), \quad (\text{E.29})$$

separately for the case

$$\mu = 0 \quad \Rightarrow \quad \gamma_0C\gamma_\mu\gamma_0 = -C\gamma_\mu, \quad (\text{E.30})$$

and

$$\mu = i \quad \Rightarrow \quad \gamma_0C\gamma_\mu\gamma_0 = C\gamma_\mu. \quad (\text{E.31})$$

Substituting the two cases into (E.29), we see that our interpolator transforms as a pseudovector under parity.

Our multi-particle interpolators in (3.19), (3.21) and (3.22) has each term of the form

$$\begin{aligned} \chi'(x) &= [\psi^T(x)(C\gamma_5)\psi(x)]\psi(x)(\bar{\psi}(x)\gamma_5\psi(x)) \\ &= \chi^B(x)\chi^M(x), \end{aligned} \quad (\text{E.32})$$

where  $\chi^B(x)$  and  $\chi^M(x)$  refer to the octet baryon term and meson interpolators respectively that we have used above, and  $\chi'(x)$  denotes a single term of  $\chi(x)$ . But we have already seen how  $\chi^B(x)$  and  $\chi^M(x)$  transform under parity. Therefore

$$\chi'(x) = \chi^B(x)\chi^M(x) \rightarrow -\gamma_0\chi^B(\tilde{x})\chi^M(\tilde{x}) = -\gamma_0\chi'(\tilde{x}). \quad (\text{E.33})$$

We note the presence of the minus sign. This is of importance as it results in a given parity state propagating in the opposite Dirac quadrant of the correlation function, as compared to an interpolator that transforms without the sign. This was observed in section 3.1.



# Appendix F

## Correlation Functions

The two-point correlation functions for the five-quark operator proton,  $\Delta^{++}$  and  $\Lambda$  interpolators, with an arbitrary set of  $\gamma$ -matrices, before imposing isospin symmetry are presented here. We denote the NK-type correlation function as  $\mathcal{G}_2^\Lambda$  to distinguish it from the pure flavour singlet correlator which is denoted  $\mathcal{G}_2^{\Lambda^1}$ . In addition, the maximally canceled two-point function for the flavour singlet  $\Lambda$  is presented here rather than in the text due to its size, and is denoted  $\mathcal{G}_2^{\Lambda^1\text{can.}}$ . We also demonstrate the equivalence of various two-point functions after imposing isospin symmetry, and at the  $SU(3)$  flavour limit.

### F.1 Two-Particle Proton Correlation Function

$$\begin{aligned}
\mathcal{G}_2^p(t, \vec{p}) = & \sum_{\vec{x}} e^{-i\vec{p}\cdot\vec{x}} \epsilon^{abc} \epsilon^{a'b'c'} \left[ \right. \\
& - 4\Gamma_2 D^{cc'}(x, 0) (\gamma_0 \Gamma_2^\dagger \gamma_0) \text{Tr} [\Gamma_1 D^{be}(x, x) \Gamma_3 \\
& \quad \times U^{ea'}(x, 0) (\gamma_0 \Gamma_1^\dagger \gamma_0)^T D^{e'b'T}(0, 0) (\gamma_0 \Gamma_3^\dagger \gamma_0)^T U^{ae'T}(x, 0)] \\
& + 4\Gamma_2 D^{cc'}(x, 0) (\gamma_0 \Gamma_2^\dagger \gamma_0) \text{Tr} [\Gamma_1 D^{be}(x, x) \Gamma_3 \\
& \quad \times U^{ee'}(x, 0) (\gamma_0 \Gamma_3^\dagger \gamma_0) D^{e'b'}(0, 0) (\gamma_0 \Gamma_1^\dagger \gamma_0) U^{aa'T}(x, 0)] \\
& + 4\Gamma_2 D^{cb'}(x, 0) (\gamma_0 \Gamma_1^\dagger \gamma_0) U^{ea'T}(x, 0) \Gamma_3^T D^{be'T}(x, x) \Gamma_1^T \\
& \quad \times U^{ae'}(x, 0) (\gamma_0 \Gamma_3^\dagger \gamma_0) D^{e'c'}(0, 0) (\gamma_0 \Gamma_2^\dagger \gamma_0) \\
& - 4\Gamma_2 D^{cb'}(x, 0) (\gamma_0 \Gamma_1^\dagger \gamma_0) U^{aa'T}(x, 0) \Gamma_1 D^{be}(x, x) \Gamma_3 \\
& \quad \times U^{ee'}(x, 0) (\gamma_0 \Gamma_3^\dagger \gamma_0) D^{e'c'}(0, 0) (\gamma_0 \Gamma_2^\dagger \gamma_0) \\
& + 4\Gamma_2 D^{ce}(x, x) \Gamma_3 U^{ea'}(x, 0) (\gamma_0 \Gamma_1^\dagger \gamma_0)^T D^{e'b'T}(0, 0) (\gamma_0 \Gamma_3^\dagger \gamma_0)^T \\
& \quad \times U^{ae'T}(x, 0) \Gamma_1 D^{bc'}(x, 0) (\gamma_0 \Gamma_2^\dagger \gamma_0)
\end{aligned}$$

$$\begin{aligned}
& - 4\Gamma_2 D^{ce}(x, x) \Gamma_3 U^{ee'}(x, 0) (\gamma_0 \Gamma_3^\dagger \gamma_0) D^{e'b'}(0, 0) (\gamma_0 \Gamma_1^\dagger \gamma_0) \\
& \quad \times U^{aa'T}(x, 0) \Gamma_1 D^{bc'}(x, 0) (\gamma_0 \Gamma_2^\dagger \gamma_0) \\
& - 4\Gamma_2 D^{cb'}(x, 0) (\gamma_0 \Gamma_1^\dagger \gamma_0) U^{ea'T}(x, 0) \Gamma_3^T D^{e'e^T}(0, x) (\gamma_0 \Gamma_3^\dagger \gamma_0)^T \\
& \quad \times U^{ae'T}(x, 0) \Gamma_1 D^{bc'}(x, 0) (\gamma_0 \Gamma_2^\dagger \gamma_0) \\
& + 4\Gamma_2 D^{cb'}(x, 0) (\gamma_0 \Gamma_1^\dagger \gamma_0) U^{aa'T}(x, 0) \Gamma_1 D^{bc'}(x, 0) (\gamma_0 \Gamma_2^\dagger \gamma_0) \\
& \quad \times \text{Tr}[\Gamma_3 U^{ee'}(x, 0) (\gamma_0 \Gamma_3^\dagger \gamma_0) D^{e'e}(0, x)] \\
& - 4\Gamma_2 D^{ce}(x, x) \Gamma_3 U^{ea'}(x, 0) (\gamma_0 \Gamma_1^\dagger \gamma_0)^T D^{bb'T}(x, 0) \Gamma_1^T \\
& \quad \times U^{ae'}(x, 0) (\gamma_0 \Gamma_3^\dagger \gamma_0) D^{e'c'}(0, 0) (\gamma_0 \Gamma_2^\dagger \gamma_0) \\
& + 4\Gamma_2 D^{ce}(x, x) \Gamma_3 U^{ee'}(x, 0) (\gamma_0 \Gamma_3^\dagger \gamma_0) D^{e'c'}(0, 0) (\gamma_0 \Gamma_2^\dagger \gamma_0) \\
& \quad \times \text{Tr}[\Gamma_1 D^{bb'}(x, 0) (\gamma_0 \Gamma_1^\dagger \gamma_0) U^{aa'T}(x, 0)] \\
& + 4\Gamma_2 D^{cc'}(x, 0) (\gamma_0 \Gamma_2^\dagger \gamma_0) \text{Tr}[\Gamma_1 D^{bb'}(x, 0) (\gamma_0 \Gamma_1^\dagger \gamma_0) \\
& \quad \times U^{ea'T}(x, 0) \Gamma_3^T D^{e'e^T}(0, x) (\gamma_0 \Gamma_3^\dagger \gamma_0)^T U^{ae'T}(x, 0)] \\
& - 4\Gamma_2 D^{cc'}(x, 0) (\gamma_0 \Gamma_2^\dagger \gamma_0) \text{Tr}[\Gamma_1 D^{bb'}(x, 0) (\gamma_0 \Gamma_1^\dagger \gamma_0) \\
& \quad \times U^{aa'T}(x, 0)] \text{Tr}[\Gamma_3 U^{ee'}(x, 0) (\gamma_0 \Gamma_3^\dagger \gamma_0) D^{e'e}(0, x)] \\
& - 2\Gamma_2 D^{ce'}(x, 0) (\gamma_0 \Gamma_3^\dagger \gamma_0) D^{e'b'}(0, 0) (\gamma_0 \Gamma_1^\dagger \gamma_0) U^{ea'T}(x, 0) \Gamma_3^T \\
& \quad \times D^{be^T}(x, x) \Gamma_1^T U^{ac'}(x, 0) (\gamma_0 \Gamma_2^\dagger \gamma_0) \\
& + 2\Gamma_2 D^{ce'}(x, 0) (\gamma_0 \Gamma_3^\dagger \gamma_0) D^{e'b'}(0, 0) (\gamma_0 \Gamma_1^\dagger \gamma_0) U^{aa'T}(x, 0) \Gamma_1 \\
& \quad \times D^{be}(x, x) \Gamma_3 U^{ec'}(x, 0) (\gamma_0 \Gamma_2^\dagger \gamma_0) \\
& + 2\Gamma_2 D^{cb'}(x, 0) (\gamma_0 \Gamma_1^\dagger \gamma_0) U^{ea'T}(x, 0) \Gamma_3^T D^{be^T}(x, x) \Gamma_1^T \\
& \quad \times U^{ac'}(x, 0) (\gamma_0 \Gamma_2^\dagger \gamma_0) \text{Tr}[(\gamma_0 \Gamma_3^\dagger \gamma_0) D^{e'e'}(0, 0)] \\
& - 2\Gamma_2 D^{cb'}(x, 0) (\gamma_0 \Gamma_1^\dagger \gamma_0) U^{aa'T}(x, 0) \Gamma_1 D^{be}(x, x) \Gamma_3 \\
& \quad \times U^{ec'}(x, 0) (\gamma_0 \Gamma_2^\dagger \gamma_0) \text{Tr}[(\gamma_0 \Gamma_3^\dagger \gamma_0) D^{e'e'}(0, 0)] \\
& + 2\Gamma_2 D^{ce}(x, x) \Gamma_3 U^{ea'}(x, 0) (\gamma_0 \Gamma_1^\dagger \gamma_0)^T D^{e'b'T}(0, 0) (\gamma_0 \Gamma_3^\dagger \gamma_0)^T \\
& \quad \times D^{be^T}(x, 0) \Gamma_1^T U^{ac'}(x, 0) (\gamma_0 \Gamma_2^\dagger \gamma_0) \\
& - 2\Gamma_2 D^{ce}(x, x) \Gamma_3 U^{ec'}(x, 0) (\gamma_0 \Gamma_2^\dagger \gamma_0) \text{Tr}[\Gamma_1 \\
& \quad \times D^{be'}(x, 0) (\gamma_0 \Gamma_3^\dagger \gamma_0) D^{e'b'}(0, 0) (\gamma_0 \Gamma_1^\dagger \gamma_0) U^{aa'T}(x, 0)] \\
& - 2\Gamma_2 D^{cb'}(x, 0) (\gamma_0 \Gamma_1^\dagger \gamma_0) U^{ea'T}(x, 0) \Gamma_3^T D^{e'e^T}(0, x) (\gamma_0 \Gamma_3^\dagger \gamma_0)^T \\
& \quad \times D^{be^T}(x, 0) \Gamma_1^T U^{ac'}(x, 0) (\gamma_0 \Gamma_2^\dagger \gamma_0) \\
& + 2\Gamma_2 D^{cb'}(x, 0) (\gamma_0 \Gamma_1^\dagger \gamma_0) U^{aa'T}(x, 0) \Gamma_1 D^{be'}(x, 0) (\gamma_0 \Gamma_3^\dagger \gamma_0) \\
& \quad \times D^{e'e}(0, x) \Gamma_3 U^{ec'}(x, 0) (\gamma_0 \Gamma_2^\dagger \gamma_0) \\
& - 2\Gamma_2 D^{ce}(x, x) \Gamma_3 U^{ea'}(x, 0) (\gamma_0 \Gamma_1^\dagger \gamma_0)^T D^{bb'T}(x, 0) \Gamma_1^T
\end{aligned}$$



$$\begin{aligned}
& \times U^{ac'}(x, 0)(\gamma_0 \Gamma_2^\dagger \gamma_0) \text{Tr}[(\gamma_0 \Gamma_3^\dagger \gamma_0) D^{e'e'}(0, 0)] \\
& + 2\Gamma_2 D^{ce}(x, x) \Gamma_3 U^{ec'}(x, 0)(\gamma_0 \Gamma_2^\dagger \gamma_0) \text{Tr}[\Gamma_1 \\
& \quad \times D^{bb'}(x, 0)(\gamma_0 \Gamma_1^\dagger \gamma_0) U^{aa'T}(x, 0)] \text{Tr}[(\gamma_0 \Gamma_3^\dagger \gamma_0) D^{e'e'}(0, 0)] \\
& + 2\Gamma_2 D^{ce'}(x, 0)(\gamma_0 \Gamma_3^\dagger \gamma_0) D^{e'e}(0, x) \Gamma_3 U^{ea'}(x, 0)(\gamma_0 \Gamma_1^\dagger \gamma_0)^T \\
& \quad \times D^{bb'T}(x, 0) \Gamma_1^T U^{ac'}(x, 0)(\gamma_0 \Gamma_2^\dagger \gamma_0) \\
& - 2\Gamma_2 D^{ce'}(x, 0)(\gamma_0 \Gamma_3^\dagger \gamma_0) D^{e'e}(0, x) \Gamma_3 U^{ec'}(x, 0)(\gamma_0 \Gamma_2^\dagger \gamma_0) \\
& \quad \times \text{Tr}[\Gamma_1 D^{bb'}(x, 0)(\gamma_0 \Gamma_1^\dagger \gamma_0) U^{aa'T}(x, 0)] \\
& - 2\Gamma_2 D^{cb'}(x, 0)(\gamma_0 \Gamma_1^\dagger \gamma_0) U^{e'a'T}(0, 0)(\gamma_0 \Gamma_3^\dagger \gamma_0)^T U^{ae'T}(x, 0) \Gamma_1 \\
& \quad \times D^{be}(x, x) \Gamma_3 U^{ec'}(x, 0)(\gamma_0 \Gamma_2^\dagger \gamma_0) \\
& + 2\Gamma_2 D^{cb'}(x, 0)(\gamma_0 \Gamma_1^\dagger \gamma_0) U^{ea'T}(x, 0) \Gamma_3^T D^{beT}(x, x) \Gamma_1^T \\
& \quad \times U^{ae'}(x, 0)(\gamma_0 \Gamma_3^\dagger \gamma_0) U^{e'c'}(0, 0)(\gamma_0 \Gamma_2^\dagger \gamma_0) \\
& + 2\Gamma_2 D^{cb'}(x, 0)(\gamma_0 \Gamma_1^\dagger \gamma_0) U^{e'a'T}(0, 0)(\gamma_0 \Gamma_3^\dagger \gamma_0)^T U^{ee'T}(x, 0) \Gamma_3^T \\
& \quad \times D^{beT}(x, x) \Gamma_1^T U^{ac'}(x, 0)(\gamma_0 \Gamma_2^\dagger \gamma_0) \\
& - 2\Gamma_2 D^{cb'}(x, 0)(\gamma_0 \Gamma_1^\dagger \gamma_0) U^{ea'T}(x, 0) \Gamma_3^T D^{beT}(x, x) \Gamma_1^T \\
& \quad \times U^{ac'}(x, 0)(\gamma_0 \Gamma_2^\dagger \gamma_0) \text{Tr}[(\gamma_0 \Gamma_3^\dagger \gamma_0) U^{e'e'}(0, 0)] \\
& - 2\Gamma_2 D^{cb'}(x, 0)(\gamma_0 \Gamma_1^\dagger \gamma_0) U^{aa'T}(x, 0) \Gamma_1 D^{be}(x, x) \Gamma_3 \\
& \quad \times U^{ee'}(x, 0)(\gamma_0 \Gamma_3^\dagger \gamma_0) U^{e'c'}(0, 0)(\gamma_0 \Gamma_2^\dagger \gamma_0) \\
& + 2\Gamma_2 D^{cb'}(x, 0)(\gamma_0 \Gamma_1^\dagger \gamma_0) U^{aa'T}(x, 0) \Gamma_1 D^{be}(x, x) \Gamma_3 \\
& \quad \times U^{ec'}(x, 0)(\gamma_0 \Gamma_2^\dagger \gamma_0) \text{Tr}[(\gamma_0 \Gamma_3^\dagger \gamma_0) U^{e'e'}(0, 0)] \\
& + 2\Gamma_2 D^{ce}(x, x) \Gamma_3 U^{ec'}(x, 0)(\gamma_0 \Gamma_2^\dagger \gamma_0) \text{Tr}[\Gamma_1 \\
& \quad \times D^{bb'}(x, 0)(\gamma_0 \Gamma_1^\dagger \gamma_0) U^{e'a'T}(0, 0)(\gamma_0 \Gamma_3^\dagger \gamma_0)^T U^{ae'T}(x, 0)] \\
& - 2\Gamma_2 D^{ce}(x, x) \Gamma_3 U^{ea'}(x, 0)(\gamma_0 \Gamma_1^\dagger \gamma_0)^T D^{bb'T}(x, 0) \Gamma_1^T \\
& \quad \times U^{ae'}(x, 0)(\gamma_0 \Gamma_3^\dagger \gamma_0) U^{e'c'}(0, 0)(\gamma_0 \Gamma_2^\dagger \gamma_0) \\
& - 2\Gamma_2 D^{ce}(x, x) \Gamma_3 U^{ee'}(x, 0)(\gamma_0 \Gamma_3^\dagger \gamma_0) U^{e'a'}(0, 0)(\gamma_0 \Gamma_1^\dagger \gamma_0)^T \\
& \quad \times D^{bb'T}(x, 0) \Gamma_1^T U^{ac'}(x, 0)(\gamma_0 \Gamma_2^\dagger \gamma_0) \\
& + 2\Gamma_2 D^{ce}(x, x) \Gamma_3 U^{ea'}(x, 0)(\gamma_0 \Gamma_1^\dagger \gamma_0)^T D^{bb'T}(x, 0) \Gamma_1^T \\
& \quad \times U^{ac'}(x, 0)(\gamma_0 \Gamma_2^\dagger \gamma_0) \text{Tr}[(\gamma_0 \Gamma_3^\dagger \gamma_0) U^{e'e'}(0, 0)] \\
& + 2\Gamma_2 D^{ce}(x, x) \Gamma_3 U^{ee'}(x, 0)(\gamma_0 \Gamma_3^\dagger \gamma_0) U^{e'c'}(0, 0)(\gamma_0 \Gamma_2^\dagger \gamma_0) \\
& \quad \times \text{Tr}[\Gamma_1 D^{bb'}(x, 0)(\gamma_0 \Gamma_1^\dagger \gamma_0) U^{aa'T}(x, 0)] \\
& - 2\Gamma_2 D^{ce}(x, x) \Gamma_3 U^{ec'}(x, 0)(\gamma_0 \Gamma_2^\dagger \gamma_0) \text{Tr}[\Gamma_1 \\
& \quad \times D^{bb'}(x, 0)(\gamma_0 \Gamma_1^\dagger \gamma_0) U^{aa'T}(x, 0)] \text{Tr}[(\gamma_0 \Gamma_3^\dagger \gamma_0) U^{e'e'}(0, 0)]
\end{aligned}$$

$$\begin{aligned}
& - 2\Gamma_2 U^{ca'}(x, 0)(\gamma_0 \Gamma_1^\dagger \gamma_0)^T D^{e'b'T}(0, 0)(\gamma_0 \Gamma_3^\dagger \gamma_0)^T U^{ae'T}(x, 0)\Gamma_1 \\
& \quad \times D^{be}(x, x)\Gamma_3 D^{ec'}(x, 0)(\gamma_0 \Gamma_2^\dagger \gamma_0) \\
& + 2\Gamma_2 U^{ce'}(x, 0)(\gamma_0 \Gamma_3^\dagger \gamma_0) D^{e'b'}(0, 0)(\gamma_0 \Gamma_1^\dagger \gamma_0) U^{aa'T}(x, 0)\Gamma_1 \\
& \quad \times D^{be}(x, x)\Gamma_3 D^{ec'}(x, 0)(\gamma_0 \Gamma_2^\dagger \gamma_0) \\
& + 2\Gamma_2 U^{ca'}(x, 0)(\gamma_0 \Gamma_1^\dagger \gamma_0)^T D^{eb'T}(x, 0)\Gamma_3^T D^{be'T}(x, x)\Gamma_1^T \\
& \quad \times U^{ae'}(x, 0)(\gamma_0 \Gamma_3^\dagger \gamma_0) D^{e'c'}(0, 0)(\gamma_0 \Gamma_2^\dagger \gamma_0) \\
& - 2\Gamma_2 U^{ce'}(x, 0)(\gamma_0 \Gamma_3^\dagger \gamma_0) D^{e'c'}(0, 0)(\gamma_0 \Gamma_2^\dagger \gamma_0) \text{Tr}[\Gamma_1 \\
& \quad \times D^{be}(x, x)\Gamma_3 D^{eb'}(x, 0)(\gamma_0 \Gamma_1^\dagger \gamma_0) U^{aa'T}(x, 0)] \\
& + 2\Gamma_2 U^{ca'}(x, 0)(\gamma_0 \Gamma_1^\dagger \gamma_0)^T D^{e'b'T}(0, 0)(\gamma_0 \Gamma_3^\dagger \gamma_0)^T U^{ae'T}(x, 0)\Gamma_1 \\
& \quad \times D^{bc'}(x, 0)(\gamma_0 \Gamma_2^\dagger \gamma_0) \text{Tr}[\Gamma_3 D^{ee}(x, x)] \\
& - 2\Gamma_2 U^{ce'}(x, 0)(\gamma_0 \Gamma_3^\dagger \gamma_0) D^{e'b'}(0, 0)(\gamma_0 \Gamma_1^\dagger \gamma_0) U^{aa'T}(x, 0)\Gamma_1 \\
& \quad \times D^{bc'}(x, 0)(\gamma_0 \Gamma_2^\dagger \gamma_0) \text{Tr}[\Gamma_3 D^{ee}(x, x)] \\
& - 2\Gamma_2 U^{ca'}(x, 0)(\gamma_0 \Gamma_1^\dagger \gamma_0)^T D^{eb'T}(x, 0)\Gamma_3^T D^{e'e'T}(0, x)(\gamma_0 \Gamma_3^\dagger \gamma_0)^T \\
& \quad \times U^{ae'T}(x, 0)\Gamma_1 D^{bc'}(x, 0)(\gamma_0 \Gamma_2^\dagger \gamma_0) \\
& + 2\Gamma_2 U^{ce'}(x, 0)(\gamma_0 \Gamma_3^\dagger \gamma_0) D^{e'e}(0, x)\Gamma_3 D^{eb'}(x, 0)(\gamma_0 \Gamma_1^\dagger \gamma_0) \\
& \quad \times U^{aa'T}(x, 0)\Gamma_1 D^{bc'}(x, 0)(\gamma_0 \Gamma_2^\dagger \gamma_0) \\
& - 2\Gamma_2 U^{ca'}(x, 0)(\gamma_0 \Gamma_1^\dagger \gamma_0)^T D^{bb'T}(x, 0)\Gamma_1^T U^{ae'}(x, 0)(\gamma_0 \Gamma_3^\dagger \gamma_0) \\
& \quad \times D^{e'c'}(0, 0)(\gamma_0 \Gamma_2^\dagger \gamma_0) \text{Tr}[\Gamma_3 D^{ee}(x, x)] \\
& + 2\Gamma_2 U^{ce'}(x, 0)(\gamma_0 \Gamma_3^\dagger \gamma_0) D^{e'c'}(0, 0)(\gamma_0 \Gamma_2^\dagger \gamma_0) \text{Tr}[\Gamma_1 \\
& \quad \times D^{bb'}(x, 0)(\gamma_0 \Gamma_1^\dagger \gamma_0) U^{aa'T}(x, 0)] \text{Tr}[\Gamma_3 D^{ee}(x, x)] \\
& + 2\Gamma_2 U^{ca'}(x, 0)(\gamma_0 \Gamma_1^\dagger \gamma_0)^T D^{bb'T}(x, 0)\Gamma_1^T U^{ae'}(x, 0)(\gamma_0 \Gamma_3^\dagger \gamma_0) \\
& \quad \times D^{e'e}(0, x)\Gamma_3 D^{ec'}(x, 0)(\gamma_0 \Gamma_2^\dagger \gamma_0) \\
& - 2\Gamma_2 U^{ce'}(x, 0)(\gamma_0 \Gamma_3^\dagger \gamma_0) D^{e'e}(0, x)\Gamma_3 D^{ec'}(x, 0)(\gamma_0 \Gamma_2^\dagger \gamma_0) \\
& \quad \times \text{Tr}[\Gamma_1 D^{bb'}(x, 0)(\gamma_0 \Gamma_1^\dagger \gamma_0) U^{aa'T}(x, 0)] \\
& - \Gamma_2 U^{ca'}(x, 0)(\gamma_0 \Gamma_1^\dagger \gamma_0)^T D^{e'b'T}(0, 0)(\gamma_0 \Gamma_3^\dagger \gamma_0)^T D^{ee'T}(x, 0)\Gamma_3^T \\
& \quad \times D^{be'T}(x, x)\Gamma_1^T U^{ac'}(x, 0)(\gamma_0 \Gamma_2^\dagger \gamma_0) \\
& + \Gamma_2 U^{cc'}(x, 0)(\gamma_0 \Gamma_2^\dagger \gamma_0) \text{Tr}[\Gamma_1 D^{be}(x, x)\Gamma_3 \\
& \quad \times D^{ee'}(x, 0)(\gamma_0 \Gamma_3^\dagger \gamma_0) D^{e'b'}(0, 0)(\gamma_0 \Gamma_1^\dagger \gamma_0) U^{aa'T}(x, 0)] \\
& + \Gamma_2 U^{ca'}(x, 0)(\gamma_0 \Gamma_1^\dagger \gamma_0)^T D^{eb'T}(x, 0)\Gamma_3^T D^{be'T}(x, x)\Gamma_1^T \\
& \quad \times U^{ac'}(x, 0)(\gamma_0 \Gamma_2^\dagger \gamma_0) \text{Tr}[(\gamma_0 \Gamma_3^\dagger \gamma_0) D^{e'e'}(0, 0)] \\
& - \Gamma_2 U^{cc'}(x, 0)(\gamma_0 \Gamma_2^\dagger \gamma_0) \text{Tr}[\Gamma_1 D^{be}(x, x)\Gamma_3
\end{aligned}$$

$$\begin{aligned}
& \times D^{eb'}(x, 0)(\gamma_0 \Gamma_1^\dagger \gamma_0) U^{aa'T}(x, 0) \text{Tr}[(\gamma_0 \Gamma_3^\dagger \gamma_0) D^{e'e'}(0, 0)] \\
& + \Gamma_2 U^{ca'}(x, 0)(\gamma_0 \Gamma_1^\dagger \gamma_0)^T D^{e'b'T}(0, 0)(\gamma_0 \Gamma_3^\dagger \gamma_0)^T D^{be'T}(x, 0) \Gamma_1^T \\
& \quad \times U^{ac'}(x, 0)(\gamma_0 \Gamma_2^\dagger \gamma_0) \text{Tr}[\Gamma_3 D^{ee}(x, x)] \\
& - \Gamma_2 U^{cc'}(x, 0)(\gamma_0 \Gamma_2^\dagger \gamma_0) \text{Tr}[\Gamma_1 D^{be'}(x, 0)(\gamma_0 \Gamma_3^\dagger \gamma_0) \\
& \quad \times D^{e'b'}(0, 0)(\gamma_0 \Gamma_1^\dagger \gamma_0) U^{aa'T}(x, 0)] \text{Tr}[\Gamma_3 D^{ee}(x, x)] \\
& - \Gamma_2 U^{ca'}(x, 0)(\gamma_0 \Gamma_1^\dagger \gamma_0)^T D^{eb'T}(x, 0) \Gamma_3^T D^{e'e'T}(0, x)(\gamma_0 \Gamma_3^\dagger \gamma_0)^T \\
& \quad \times D^{be'T}(x, 0) \Gamma_1^T U^{ac'}(x, 0)(\gamma_0 \Gamma_2^\dagger \gamma_0) \\
& + \Gamma_2 U^{cc'}(x, 0)(\gamma_0 \Gamma_2^\dagger \gamma_0) \text{Tr}[\Gamma_1 D^{be'}(x, 0)(\gamma_0 \Gamma_3^\dagger \gamma_0) \\
& \quad \times D^{e'e}(0, x) \Gamma_3 D^{eb'}(x, 0)(\gamma_0 \Gamma_1^\dagger \gamma_0) U^{aa'T}(x, 0)] \\
& - \Gamma_2 U^{ca'}(x, 0)(\gamma_0 \Gamma_1^\dagger \gamma_0)^T D^{bb'T}(x, 0) \Gamma_1^T U^{ac'}(x, 0)(\gamma_0 \Gamma_2^\dagger \gamma_0) \\
& \quad \times \text{Tr}[\Gamma_3 D^{ee}(x, x)] \text{Tr}[(\gamma_0 \Gamma_3^\dagger \gamma_0) D^{e'e'}(0, 0)] \\
& + \Gamma_2 U^{cc'}(x, 0)(\gamma_0 \Gamma_2^\dagger \gamma_0) \text{Tr}[\Gamma_1 D^{bb'}(x, 0)(\gamma_0 \Gamma_1^\dagger \gamma_0) \\
& \quad \times U^{aa'T}(x, 0)] \text{Tr}[\Gamma_3 D^{ee}(x, x)] \text{Tr}[(\gamma_0 \Gamma_3^\dagger \gamma_0) D^{e'e'}(0, 0)] \\
& + \Gamma_2 U^{ca'}(x, 0)(\gamma_0 \Gamma_1^\dagger \gamma_0)^T D^{bb'T}(x, 0) \Gamma_1^T U^{ac'}(x, 0)(\gamma_0 \Gamma_2^\dagger \gamma_0) \\
& \quad \times \text{Tr}[\Gamma_3 D^{ee'}(x, 0)(\gamma_0 \Gamma_3^\dagger \gamma_0) D^{e'e}(0, x)] \\
& - \Gamma_2 U^{cc'}(x, 0)(\gamma_0 \Gamma_2^\dagger \gamma_0) \text{Tr}[\Gamma_1 D^{bb'}(x, 0)(\gamma_0 \Gamma_1^\dagger \gamma_0) \\
& \quad \times U^{aa'T}(x, 0)] \text{Tr}[\Gamma_3 D^{ee'}(x, 0)(\gamma_0 \Gamma_3^\dagger \gamma_0) D^{e'e}(0, x)] \\
& - \Gamma_2 U^{cc'}(x, 0)(\gamma_0 \Gamma_2^\dagger \gamma_0) \text{Tr}[\Gamma_1 D^{be}(x, x) \Gamma_3 \\
& \quad \times D^{eb'}(x, 0)(\gamma_0 \Gamma_1^\dagger \gamma_0) U^{e'a'T}(0, 0)(\gamma_0 \Gamma_3^\dagger \gamma_0)^T U^{ae'T}(x, 0)] \\
& + \Gamma_2 U^{ca'}(x, 0)(\gamma_0 \Gamma_1^\dagger \gamma_0)^T D^{eb'T}(x, 0) \Gamma_3^T D^{be'T}(x, x) \Gamma_1^T \\
& \quad \times U^{ae'}(x, 0)(\gamma_0 \Gamma_3^\dagger \gamma_0) U^{e'c'}(0, 0)(\gamma_0 \Gamma_2^\dagger \gamma_0) \\
& + \Gamma_2 U^{cc'}(x, 0)(\gamma_0 \Gamma_3^\dagger \gamma_0) U^{e'a'}(0, 0)(\gamma_0 \Gamma_1^\dagger \gamma_0)^T D^{eb'T}(x, 0) \Gamma_3^T \\
& \quad \times D^{be'T}(x, x) \Gamma_1^T U^{ac'}(x, 0)(\gamma_0 \Gamma_2^\dagger \gamma_0) \\
& - \Gamma_2 U^{ca'}(x, 0)(\gamma_0 \Gamma_1^\dagger \gamma_0)^T D^{eb'T}(x, 0) \Gamma_3^T D^{be'T}(x, x) \Gamma_1^T \\
& \quad \times U^{ac'}(x, 0)(\gamma_0 \Gamma_2^\dagger \gamma_0) \text{Tr}[(\gamma_0 \Gamma_3^\dagger \gamma_0) U^{e'e'}(0, 0)] \\
& - \Gamma_2 U^{cc'}(x, 0)(\gamma_0 \Gamma_3^\dagger \gamma_0) U^{e'c'}(0, 0)(\gamma_0 \Gamma_2^\dagger \gamma_0) \text{Tr}[\Gamma_1 \\
& \quad \times D^{be}(x, x) \Gamma_3 D^{eb'}(x, 0)(\gamma_0 \Gamma_1^\dagger \gamma_0) U^{aa'T}(x, 0)] \\
& + \Gamma_2 U^{cc'}(x, 0)(\gamma_0 \Gamma_2^\dagger \gamma_0) \text{Tr}[\Gamma_1 D^{be}(x, x) \Gamma_3 \\
& \quad \times D^{eb'}(x, 0)(\gamma_0 \Gamma_1^\dagger \gamma_0) U^{aa'T}(x, 0)] \text{Tr}[(\gamma_0 \Gamma_3^\dagger \gamma_0) U^{e'e'}(0, 0)] \\
& + \Gamma_2 U^{cc'}(x, 0)(\gamma_0 \Gamma_2^\dagger \gamma_0) \text{Tr}[\Gamma_1 D^{bb'}(x, 0)(\gamma_0 \Gamma_1^\dagger \gamma_0) \\
& \quad \times U^{e'a'T}(0, 0)(\gamma_0 \Gamma_3^\dagger \gamma_0)^T U^{ae'T}(x, 0)] \text{Tr}[\Gamma_3 D^{ee}(x, x)]
\end{aligned}$$

$$\begin{aligned}
& - \Gamma_2 U^{ca'}(x, 0)(\gamma_0 \Gamma_1^\dagger \gamma_0)^T D^{bb'T}(x, 0) \Gamma_1^T U^{ae'}(x, 0)(\gamma_0 \Gamma_3^\dagger \gamma_0) \\
& \quad \times U^{e'c'}(0, 0)(\gamma_0 \Gamma_2^\dagger \gamma_0) \text{Tr}[\Gamma_3 D^{ee}(x, x)] \\
& - \Gamma_2 U^{ce'}(x, 0)(\gamma_0 \Gamma_3^\dagger \gamma_0) U^{e'a'}(0, 0)(\gamma_0 \Gamma_1^\dagger \gamma_0)^T D^{bb'T}(x, 0) \Gamma_1^T \\
& \quad \times U^{ac'}(x, 0)(\gamma_0 \Gamma_2^\dagger \gamma_0) \text{Tr}[\Gamma_3 D^{ee}(x, x)] \\
& + \Gamma_2 U^{ca'}(x, 0)(\gamma_0 \Gamma_1^\dagger \gamma_0)^T D^{bb'T}(x, 0) \Gamma_1^T U^{ac'}(x, 0)(\gamma_0 \Gamma_2^\dagger \gamma_0) \\
& \quad \times \text{Tr}[\Gamma_3 D^{ee}(x, x)] \text{Tr}[(\gamma_0 \Gamma_3^\dagger \gamma_0) U^{e'e'}(0, 0)] \\
& + \Gamma_2 U^{ce'}(x, 0)(\gamma_0 \Gamma_3^\dagger \gamma_0) U^{e'c'}(0, 0)(\gamma_0 \Gamma_2^\dagger \gamma_0) \text{Tr}[\Gamma_1 \\
& \quad \times D^{bb'}(x, 0)(\gamma_0 \Gamma_1^\dagger \gamma_0) U^{aa'T}(x, 0)] \text{Tr}[\Gamma_3 D^{ee}(x, x)] \\
& - \Gamma_2 U^{ce'}(x, 0)(\gamma_0 \Gamma_2^\dagger \gamma_0) \text{Tr}[\Gamma_1 D^{bb'}(x, 0)(\gamma_0 \Gamma_1^\dagger \gamma_0) \\
& \quad \times U^{aa'T}(x, 0)] \text{Tr}[\Gamma_3 D^{ee}(x, x)] \text{Tr}[(\gamma_0 \Gamma_3^\dagger \gamma_0) U^{e'e'}(0, 0)] \\
& - 2\Gamma_2 U^{ce'}(x, 0)(\gamma_0 \Gamma_3^\dagger \gamma_0) D^{e'b'}(0, 0)(\gamma_0 \Gamma_1^\dagger \gamma_0) U^{ea'T}(x, 0) \Gamma_3^T \\
& \quad \times U^{ae'T}(x, x) \Gamma_1 D^{bc'}(x, 0)(\gamma_0 \Gamma_2^\dagger \gamma_0) \\
& + 2\Gamma_2 U^{ca'}(x, 0)(\gamma_0 \Gamma_1^\dagger \gamma_0)^T D^{e'b'T}(0, 0)(\gamma_0 \Gamma_3^\dagger \gamma_0)^T U^{ee'T}(x, 0) \Gamma_3^T \\
& \quad \times U^{ae'T}(x, x) \Gamma_1 D^{bc'}(x, 0)(\gamma_0 \Gamma_2^\dagger \gamma_0) \\
& + 2\Gamma_2 U^{ce}(x, x) \Gamma_3 U^{ea'}(x, 0)(\gamma_0 \Gamma_1^\dagger \gamma_0)^T D^{e'b'T}(0, 0)(\gamma_0 \Gamma_3^\dagger \gamma_0)^T \\
& \quad \times U^{ae'T}(x, 0) \Gamma_1 D^{bc'}(x, 0)(\gamma_0 \Gamma_2^\dagger \gamma_0) \\
& - 2\Gamma_2 U^{ca'}(x, 0)(\gamma_0 \Gamma_1^\dagger \gamma_0)^T D^{e'b'T}(0, 0)(\gamma_0 \Gamma_3^\dagger \gamma_0)^T U^{ae'T}(x, 0) \Gamma_1 \\
& \quad \times D^{bc'}(x, 0)(\gamma_0 \Gamma_2^\dagger \gamma_0) \text{Tr}[\Gamma_3 U^{ee}(x, x)] \\
& - 2\Gamma_2 U^{ce}(x, x) \Gamma_3 U^{ee'}(x, 0)(\gamma_0 \Gamma_3^\dagger \gamma_0) D^{e'b'}(0, 0)(\gamma_0 \Gamma_1^\dagger \gamma_0) \\
& \quad \times U^{aa'T}(x, 0) \Gamma_1 D^{bc'}(x, 0)(\gamma_0 \Gamma_2^\dagger \gamma_0) \\
& + 2\Gamma_2 U^{ce'}(x, 0)(\gamma_0 \Gamma_3^\dagger \gamma_0) D^{e'b'}(0, 0)(\gamma_0 \Gamma_1^\dagger \gamma_0) U^{aa'T}(x, 0) \Gamma_1 \\
& \quad \times D^{bc'}(x, 0)(\gamma_0 \Gamma_2^\dagger \gamma_0) \text{Tr}[\Gamma_3 U^{ee}(x, x)] \\
& + 2\Gamma_2 U^{ce'}(x, 0)(\gamma_0 \Gamma_3^\dagger \gamma_0) D^{e'c'}(0, 0)(\gamma_0 \Gamma_2^\dagger \gamma_0) \text{Tr}[\Gamma_1 \\
& \quad \times D^{bb'}(x, 0)(\gamma_0 \Gamma_1^\dagger \gamma_0) U^{ea'T}(x, 0) \Gamma_3^T U^{ae'T}(x, x)] \\
& - 2\Gamma_2 U^{ca'}(x, 0)(\gamma_0 \Gamma_1^\dagger \gamma_0)^T D^{bb'T}(x, 0) \Gamma_1^T U^{ae}(x, x) \Gamma_3 \\
& \quad \times U^{ee'}(x, 0)(\gamma_0 \Gamma_3^\dagger \gamma_0) D^{e'c'}(0, 0)(\gamma_0 \Gamma_2^\dagger \gamma_0) \\
& - 2\Gamma_2 U^{ce}(x, x) \Gamma_3 U^{ea'}(x, 0)(\gamma_0 \Gamma_1^\dagger \gamma_0)^T D^{bb'T}(x, 0) \Gamma_1^T \\
& \quad \times U^{ae'}(x, 0)(\gamma_0 \Gamma_3^\dagger \gamma_0) D^{e'c'}(0, 0)(\gamma_0 \Gamma_2^\dagger \gamma_0) \\
& + 2\Gamma_2 U^{ca'}(x, 0)(\gamma_0 \Gamma_1^\dagger \gamma_0)^T D^{bb'T}(x, 0) \Gamma_1^T U^{ae'}(x, 0)(\gamma_0 \Gamma_3^\dagger \gamma_0) \\
& \quad \times D^{e'c'}(0, 0)(\gamma_0 \Gamma_2^\dagger \gamma_0) \text{Tr}[\Gamma_3 U^{ee}(x, x)] \\
& + 2\Gamma_2 U^{ce}(x, x) \Gamma_3 U^{ee'}(x, 0)(\gamma_0 \Gamma_3^\dagger \gamma_0) D^{e'c'}(0, 0)(\gamma_0 \Gamma_2^\dagger \gamma_0)
\end{aligned}$$

$$\begin{aligned}
& \times \text{Tr}[\Gamma_1 D^{bb'}(x, 0)(\gamma_0 \Gamma_1^\dagger \gamma_0) U^{aa'T}(x, 0)] \\
& - 2\Gamma_2 U^{ce'}(x, 0)(\gamma_0 \Gamma_3^\dagger \gamma_0) D^{e'c'}(0, 0)(\gamma_0 \Gamma_2^\dagger \gamma_0) \text{Tr}[\Gamma_1 \\
& \quad \times D^{bb'}(x, 0)(\gamma_0 \Gamma_1^\dagger \gamma_0) U^{aa'T}(x, 0)] \text{Tr}[\Gamma_3 U^{ee}(x, x)] \\
& - \Gamma_2 U^{cc'}(x, 0)(\gamma_0 \Gamma_2^\dagger \gamma_0) \text{Tr}[\Gamma_1 D^{be'}(x, 0)(\gamma_0 \Gamma_3^\dagger \gamma_0) \\
& \quad \times D^{e'b'}(0, 0)(\gamma_0 \Gamma_1^\dagger \gamma_0) U^{ea'T}(x, 0) \Gamma_3^T U^{ae'T}(x, x)] \\
& + \Gamma_2 U^{ca'}(x, 0)(\gamma_0 \Gamma_1^\dagger \gamma_0)^T D^{e'b'T}(0, 0)(\gamma_0 \Gamma_3^\dagger \gamma_0)^T D^{be'T}(x, 0) \Gamma_1^T \\
& \quad \times U^{ae}(x, x) \Gamma_3 U^{ec'}(x, 0)(\gamma_0 \Gamma_2^\dagger \gamma_0) \\
& + \Gamma_2 U^{ce}(x, x) \Gamma_3 U^{ea'}(x, 0)(\gamma_0 \Gamma_1^\dagger \gamma_0)^T D^{e'b'T}(0, 0)(\gamma_0 \Gamma_3^\dagger \gamma_0)^T \\
& \quad \times D^{be'T}(x, 0) \Gamma_1^T U^{ac'}(x, 0)(\gamma_0 \Gamma_2^\dagger \gamma_0) \\
& - \Gamma_2 U^{ca'}(x, 0)(\gamma_0 \Gamma_1^\dagger \gamma_0)^T D^{e'b'T}(0, 0)(\gamma_0 \Gamma_3^\dagger \gamma_0)^T D^{be'T}(x, 0) \Gamma_1^T \\
& \quad \times U^{ac'}(x, 0)(\gamma_0 \Gamma_2^\dagger \gamma_0) \text{Tr}[\Gamma_3 U^{ee}(x, x)] \\
& - \Gamma_2 U^{ce}(x, x) \Gamma_3 U^{ec'}(x, 0)(\gamma_0 \Gamma_2^\dagger \gamma_0) \text{Tr}[\Gamma_1 \\
& \quad \times D^{be'}(x, 0)(\gamma_0 \Gamma_3^\dagger \gamma_0) D^{e'b'}(0, 0)(\gamma_0 \Gamma_1^\dagger \gamma_0) U^{aa'T}(x, 0)] \\
& + \Gamma_2 U^{cc'}(x, 0)(\gamma_0 \Gamma_2^\dagger \gamma_0) \text{Tr}[\Gamma_1 D^{be'}(x, 0)(\gamma_0 \Gamma_3^\dagger \gamma_0) \\
& \quad \times D^{e'b'}(0, 0)(\gamma_0 \Gamma_1^\dagger \gamma_0) U^{aa'T}(x, 0)] \text{Tr}[\Gamma_3 U^{ee}(x, x)] \\
& + \Gamma_2 U^{cc'}(x, 0)(\gamma_0 \Gamma_2^\dagger \gamma_0) \text{Tr}[\Gamma_1 D^{bb'}(x, 0)(\gamma_0 \Gamma_1^\dagger \gamma_0) \\
& \quad \times U^{ea'T}(x, 0) \Gamma_3^T U^{ae'T}(x, x)] \text{Tr}[(\gamma_0 \Gamma_3^\dagger \gamma_0) D^{e'e'}(0, 0)] \\
& - \Gamma_2 U^{ca'}(x, 0)(\gamma_0 \Gamma_1^\dagger \gamma_0)^T D^{bb'T}(x, 0) \Gamma_1^T U^{ae}(x, x) \Gamma_3 \\
& \quad \times U^{ec'}(x, 0)(\gamma_0 \Gamma_2^\dagger \gamma_0) \text{Tr}[(\gamma_0 \Gamma_3^\dagger \gamma_0) D^{e'e'}(0, 0)] \\
& - \Gamma_2 U^{ce}(x, x) \Gamma_3 U^{ea'}(x, 0)(\gamma_0 \Gamma_1^\dagger \gamma_0)^T D^{bb'T}(x, 0) \Gamma_1^T \\
& \quad \times U^{ac'}(x, 0)(\gamma_0 \Gamma_2^\dagger \gamma_0) \text{Tr}[(\gamma_0 \Gamma_3^\dagger \gamma_0) D^{e'e'}(0, 0)] \\
& + \Gamma_2 U^{ca'}(x, 0)(\gamma_0 \Gamma_1^\dagger \gamma_0)^T D^{bb'T}(x, 0) \Gamma_1^T U^{ac'}(x, 0)(\gamma_0 \Gamma_2^\dagger \gamma_0) \\
& \quad \times \text{Tr}[\Gamma_3 U^{ee}(x, x)] \text{Tr}[(\gamma_0 \Gamma_3^\dagger \gamma_0) D^{e'e'}(0, 0)] \\
& + \Gamma_2 U^{ce}(x, x) \Gamma_3 U^{ec'}(x, 0)(\gamma_0 \Gamma_2^\dagger \gamma_0) \text{Tr}[\Gamma_1 \\
& \quad \times D^{bb'}(x, 0)(\gamma_0 \Gamma_1^\dagger \gamma_0) U^{aa'T}(x, 0)] \text{Tr}[(\gamma_0 \Gamma_3^\dagger \gamma_0) D^{e'e'}(0, 0)] \\
& - \Gamma_2 U^{cc'}(x, 0)(\gamma_0 \Gamma_2^\dagger \gamma_0) \text{Tr}[\Gamma_1 D^{bb'}(x, 0)(\gamma_0 \Gamma_1^\dagger \gamma_0) \\
& \quad \times U^{aa'T}(x, 0)] \text{Tr}[\Gamma_3 U^{ee}(x, x)] \text{Tr}[(\gamma_0 \Gamma_3^\dagger \gamma_0) D^{e'e'}(0, 0)] \\
& - \Gamma_2 U^{ce'}(x, 0)(\gamma_0 \Gamma_3^\dagger \gamma_0) U^{e'a'}(0, 0)(\gamma_0 \Gamma_1^\dagger \gamma_0)^T D^{bb'T}(x, 0) \Gamma_1^T \\
& \quad \times U^{ae}(x, x) \Gamma_3 U^{ec'}(x, 0)(\gamma_0 \Gamma_2^\dagger \gamma_0) \\
& + \Gamma_2 U^{ce'}(x, 0)(\gamma_0 \Gamma_3^\dagger \gamma_0) U^{e'c'}(0, 0)(\gamma_0 \Gamma_2^\dagger \gamma_0) \text{Tr}[\Gamma_1 \\
& \quad \times D^{bb'}(x, 0)(\gamma_0 \Gamma_1^\dagger \gamma_0) U^{ea'T}(x, 0) \Gamma_3^T U^{ae'T}(x, x)]
\end{aligned}$$

$$\begin{aligned}
& + \Gamma_2 U^{cc'}(x, 0)(\gamma_0 \Gamma_2^\dagger \gamma_0) \text{Tr} [\Gamma_1 D^{bb'}(x, 0)(\gamma_0 \Gamma_1^\dagger \gamma_0) \\
& \quad \times U^{e'a'T}(0, 0)(\gamma_0 \Gamma_3^\dagger \gamma_0)^T U^{ee'T}(x, 0) \Gamma_3^T U^{ae'T}(x, x)] \\
& - \Gamma_2 U^{cc'}(x, 0)(\gamma_0 \Gamma_2^\dagger \gamma_0) \text{Tr} [\Gamma_1 D^{bb'}(x, 0)(\gamma_0 \Gamma_1^\dagger \gamma_0) \\
& \quad \times U^{ea'T}(x, 0) \Gamma_3^T U^{ae'T}(x, x)] \text{Tr} [(\gamma_0 \Gamma_3^\dagger \gamma_0) U^{e'e'}(0, 0)] \\
& - \Gamma_2 U^{ca'}(x, 0)(\gamma_0 \Gamma_1^\dagger \gamma_0)^T D^{bb'T}(x, 0) \Gamma_1^T U^{ae}(x, x) \Gamma_3 \\
& \quad \times U^{ee'}(x, 0)(\gamma_0 \Gamma_3^\dagger \gamma_0) U^{e'c'}(0, 0)(\gamma_0 \Gamma_2^\dagger \gamma_0) \\
& + \Gamma_2 U^{ca'}(x, 0)(\gamma_0 \Gamma_1^\dagger \gamma_0)^T D^{bb'T}(x, 0) \Gamma_1^T U^{ae}(x, x) \Gamma_3 \\
& \quad \times U^{ec'}(x, 0)(\gamma_0 \Gamma_2^\dagger \gamma_0) \text{Tr} [(\gamma_0 \Gamma_3^\dagger \gamma_0) U^{e'e'}(0, 0)] \\
& + \Gamma_2 U^{ce}(x, x) \Gamma_3 U^{ec'}(x, 0)(\gamma_0 \Gamma_2^\dagger \gamma_0) \text{Tr} [\Gamma_1 \\
& \quad \times D^{bb'}(x, 0)(\gamma_0 \Gamma_1^\dagger \gamma_0) U^{e'a'T}(0, 0)(\gamma_0 \Gamma_3^\dagger \gamma_0)^T U^{ae'T}(x, 0)] \\
& - \Gamma_2 U^{ce}(x, x) \Gamma_3 U^{ea'}(x, 0)(\gamma_0 \Gamma_1^\dagger \gamma_0)^T D^{bb'T}(x, 0) \Gamma_1^T \\
& \quad \times U^{ae'}(x, 0)(\gamma_0 \Gamma_3^\dagger \gamma_0) U^{e'c'}(0, 0)(\gamma_0 \Gamma_2^\dagger \gamma_0) \\
& - \Gamma_2 U^{cc'}(x, 0)(\gamma_0 \Gamma_2^\dagger \gamma_0) \text{Tr} [\Gamma_1 D^{bb'}(x, 0)(\gamma_0 \Gamma_1^\dagger \gamma_0) \\
& \quad \times U^{e'a'T}(0, 0)(\gamma_0 \Gamma_3^\dagger \gamma_0)^T U^{ae'T}(x, 0)] \text{Tr} [\Gamma_3 U^{ee}(x, x)] \\
& + \Gamma_2 U^{cc'}(x, 0)(\gamma_0 \Gamma_2^\dagger \gamma_0) \text{Tr} [\Gamma_1 D^{bb'}(x, 0)(\gamma_0 \Gamma_1^\dagger \gamma_0) \\
& \quad \times U^{ea'T}(x, 0) \Gamma_3^T U^{e'e'T}(0, x)(\gamma_0 \Gamma_3^\dagger \gamma_0)^T U^{ae'T}(x, 0)] \\
& + \Gamma_2 U^{ca'}(x, 0)(\gamma_0 \Gamma_1^\dagger \gamma_0)^T D^{bb'T}(x, 0) \Gamma_1^T U^{ae'}(x, 0)(\gamma_0 \Gamma_3^\dagger \gamma_0) \\
& \quad \times U^{e'c'}(0, 0)(\gamma_0 \Gamma_2^\dagger \gamma_0) \text{Tr} [\Gamma_3 U^{ee}(x, x)] \\
& - \Gamma_2 U^{ca'}(x, 0)(\gamma_0 \Gamma_1^\dagger \gamma_0)^T D^{bb'T}(x, 0) \Gamma_1^T U^{ae'}(x, 0)(\gamma_0 \Gamma_3^\dagger \gamma_0) \\
& \quad \times U^{e'e}(0, x) \Gamma_3 U^{ec'}(x, 0)(\gamma_0 \Gamma_2^\dagger \gamma_0) \\
& - \Gamma_2 U^{ce}(x, x) \Gamma_3 U^{ee'}(x, 0)(\gamma_0 \Gamma_3^\dagger \gamma_0) U^{e'a'}(0, 0)(\gamma_0 \Gamma_1^\dagger \gamma_0)^T \\
& \quad \times D^{bb'T}(x, 0) \Gamma_1^T U^{ac'}(x, 0)(\gamma_0 \Gamma_2^\dagger \gamma_0) \\
& + \Gamma_2 U^{ce}(x, x) \Gamma_3 U^{ea'}(x, 0)(\gamma_0 \Gamma_1^\dagger \gamma_0)^T D^{bb'T}(x, 0) \Gamma_1^T \\
& \quad \times U^{ac'}(x, 0)(\gamma_0 \Gamma_2^\dagger \gamma_0) \text{Tr} [(\gamma_0 \Gamma_3^\dagger \gamma_0) U^{e'e'}(0, 0)] \\
& + \Gamma_2 U^{ce'}(x, 0)(\gamma_0 \Gamma_3^\dagger \gamma_0) U^{e'a'}(0, 0)(\gamma_0 \Gamma_1^\dagger \gamma_0)^T D^{bb'T}(x, 0) \Gamma_1^T \\
& \quad \times U^{ac'}(x, 0)(\gamma_0 \Gamma_2^\dagger \gamma_0) \text{Tr} [\Gamma_3 U^{ee}(x, x)] \\
& - \Gamma_2 U^{ce'}(x, 0)(\gamma_0 \Gamma_3^\dagger \gamma_0) U^{e'e}(0, x) \Gamma_3 U^{ea'}(x, 0)(\gamma_0 \Gamma_1^\dagger \gamma_0)^T \\
& \quad \times D^{bb'T}(x, 0) \Gamma_1^T U^{ac'}(x, 0)(\gamma_0 \Gamma_2^\dagger \gamma_0) \\
& - \Gamma_2 U^{ca'}(x, 0)(\gamma_0 \Gamma_1^\dagger \gamma_0)^T D^{bb'T}(x, 0) \Gamma_1^T U^{ac'}(x, 0)(\gamma_0 \Gamma_2^\dagger \gamma_0) \\
& \quad \times \text{Tr} [\Gamma_3 U^{ee}(x, x)] \text{Tr} [(\gamma_0 \Gamma_3^\dagger \gamma_0) U^{e'e'}(0, 0)] \\
& + \Gamma_2 U^{ca'}(x, 0)(\gamma_0 \Gamma_1^\dagger \gamma_0)^T D^{bb'T}(x, 0) \Gamma_1^T U^{ac'}(x, 0)(\gamma_0 \Gamma_2^\dagger \gamma_0)
\end{aligned}$$

$$\begin{aligned}
& \times \text{Tr}[\Gamma_3 U^{ee'}(x, 0)(\gamma_0 \Gamma_3^\dagger \gamma_0) U^{e'e}(0, x)] \\
& + \Gamma_2 U^{ce}(x, x) \Gamma_3 U^{ee'}(x, 0)(\gamma_0 \Gamma_3^\dagger \gamma_0) U^{e'c'}(0, 0)(\gamma_0 \Gamma_2^\dagger \gamma_0) \\
& \quad \times \text{Tr}[\Gamma_1 D^{bb'}(x, 0)(\gamma_0 \Gamma_1^\dagger \gamma_0) U^{aa^T}(x, 0)] \\
& - \Gamma_2 U^{ce}(x, x) \Gamma_3 U^{ee'}(x, 0)(\gamma_0 \Gamma_2^\dagger \gamma_0) \text{Tr}[\Gamma_1 \\
& \quad \times D^{bb'}(x, 0)(\gamma_0 \Gamma_1^\dagger \gamma_0) U^{aa^T}(x, 0)] \text{Tr}[(\gamma_0 \Gamma_3^\dagger \gamma_0) U^{e'e'}(0, 0)] \\
& - \Gamma_2 U^{ce'}(x, 0)(\gamma_0 \Gamma_3^\dagger \gamma_0) U^{e'c'}(0, 0)(\gamma_0 \Gamma_2^\dagger \gamma_0) \text{Tr}[\Gamma_1 \\
& \quad \times D^{bb'}(x, 0)(\gamma_0 \Gamma_1^\dagger \gamma_0) U^{aa^T}(x, 0)] \text{Tr}[\Gamma_3 U^{ee}(x, x)] \\
& + \Gamma_2 U^{ce'}(x, 0)(\gamma_0 \Gamma_3^\dagger \gamma_0) U^{e'e}(0, x) \Gamma_3 U^{ec'}(x, 0)(\gamma_0 \Gamma_2^\dagger \gamma_0) \\
& \quad \times \text{Tr}[\Gamma_1 D^{bb'}(x, 0)(\gamma_0 \Gamma_1^\dagger \gamma_0) U^{aa^T}(x, 0)] \\
& + \Gamma_2 U^{cc'}(x, 0)(\gamma_0 \Gamma_2^\dagger \gamma_0) \text{Tr}[\Gamma_1 D^{bb'}(x, 0)(\gamma_0 \Gamma_1^\dagger \gamma_0) \\
& \quad \times U^{aa^T}(x, 0)] \text{Tr}[\Gamma_3 U^{ee}(x, x)] \text{Tr}[(\gamma_0 \Gamma_3^\dagger \gamma_0) U^{e'e'}(0, 0)] \\
& - \Gamma_2 U^{cc'}(x, 0)(\gamma_0 \Gamma_2^\dagger \gamma_0) \text{Tr}[\Gamma_1 D^{bb'}(x, 0)(\gamma_0 \Gamma_1^\dagger \gamma_0) \\
& \quad \times U^{aa^T}(x, 0)] \text{Tr}[\Gamma_3 U^{ee'}(x, 0)(\gamma_0 \Gamma_3^\dagger \gamma_0) U^{e'e}(0, x)] \Big] \\
\end{aligned} \tag{F.1}$$

## F.2 Two-Particle $\Lambda$ Correlation Function

$$\begin{aligned}
\mathcal{G}_2^\Lambda(t, \vec{p}) = \sum_{\vec{x}} e^{-i\vec{p}\cdot\vec{x}} \epsilon^{abc} \epsilon^{a'b'c'} \Big[ \\
& + \Gamma_2 U^{ca'}(x, 0)(\gamma_0 \Gamma_1 \gamma_0)^T D^{e'b'^T}(0, 0)(\gamma_0 \Gamma_3 \gamma_0)^T S^{ee'^T}(x, 0) \Gamma_3^T \\
& \quad \times U^{ae^T}(x, x) \Gamma_1 D^{bc'}(x, 0)(\gamma_0 \Gamma_2 \gamma_0) \\
& - \Gamma_2 U^{ce}(x, x) \Gamma_3 S^{ee'}(x, 0)(\gamma_0 \Gamma_3 \gamma_0) D^{e'b'}(0, 0)(\gamma_0 \Gamma_1 \gamma_0) \\
& \quad \times U^{aa^T}(x, 0) \Gamma_1 D^{bc'}(x, 0)(\gamma_0 \Gamma_2 \gamma_0) \\
& - \Gamma_2 U^{ca'}(x, 0)(\gamma_0 \Gamma_1 \gamma_0)^T D^{bb'^T}(x, 0) \Gamma_1^T U^{ae}(x, x) \Gamma_3 \\
& \quad \times S^{ee'}(x, 0)(\gamma_0 \Gamma_3 \gamma_0) D^{e'c'}(0, 0)(\gamma_0 \Gamma_2 \gamma_0) \\
& + \Gamma_2 U^{ce}(x, x) \Gamma_3 S^{ee'}(x, 0)(\gamma_0 \Gamma_3 \gamma_0) D^{e'c'}(0, 0)(\gamma_0 \Gamma_2 \gamma_0) \\
& \quad \times \text{Tr}[\Gamma_1 D^{bb'}(x, 0)(\gamma_0 \Gamma_1 \gamma_0) U^{aa^T}(x, 0)] \\
& - \Gamma_2 U^{cc'}(x, 0)(\gamma_0 \Gamma_2 \gamma_0) \text{Tr}[\Gamma_1 D^{bb'}(x, 0)(\gamma_0 \Gamma_1 \gamma_0) \\
& \quad \times U^{e'a^T}(0, 0)(\gamma_0 \Gamma_3 \gamma_0)^T S^{ee'^T}(x, 0) \Gamma_3^T U^{ae^T}(x, x)] \\
& + \Gamma_2 U^{ca'}(x, 0)(\gamma_0 \Gamma_1 \gamma_0)^T D^{bb'^T}(x, 0) \Gamma_1^T U^{ae}(x, x) \Gamma_3 \\
& \quad \times S^{ee'}(x, 0)(\gamma_0 \Gamma_3 \gamma_0) U^{e'c'}(0, 0)(\gamma_0 \Gamma_2 \gamma_0) \\
& + \Gamma_2 U^{ce}(x, x) \Gamma_3 S^{ee'}(x, 0)(\gamma_0 \Gamma_3 \gamma_0) U^{e'a'}(0, 0)(\gamma_0 \Gamma_1 \gamma_0)^T
\end{aligned}$$

$$\begin{aligned}
& \times D^{bb'T}(x, 0)\Gamma_1^T U^{ac'}(x, 0)(\gamma_0\Gamma_2\gamma_0) \\
& - \Gamma_2 U^{ca'}(x, 0)(\gamma_0\Gamma_1\gamma_0)^T D^{bb'T}(x, 0)\Gamma_1^T U^{ac'}(x, 0)(\gamma_0\Gamma_2\gamma_0) \\
& \quad \times \text{Tr}[\Gamma_3 S^{ee'}(x, 0)(\gamma_0\Gamma_3\gamma_0)U^{e'e}(0, x)] \\
& - \Gamma_2 U^{ce}(x, x)\Gamma_3 S^{ee'}(x, 0)(\gamma_0\Gamma_3\gamma_0)U^{e'c'}(0, 0)(\gamma_0\Gamma_2\gamma_0) \\
& \quad \times \text{Tr}[\Gamma_1 D^{bb'}(x, 0)(\gamma_0\Gamma_1\gamma_0)U^{aa'T}(x, 0)] \\
& + \Gamma_2 U^{cc'}(x, 0)(\gamma_0\Gamma_2\gamma_0)\text{Tr}[\Gamma_1 D^{bb'}(x, 0)(\gamma_0\Gamma_1\gamma_0) \\
& \quad \times U^{aa'T}(x, 0)]\text{Tr}[\Gamma_3 S^{ee'}(x, 0)(\gamma_0\Gamma_3\gamma_0)U^{e'e}(0, x)] \\
& - \Gamma_2 D^{cc'}(x, 0)(\gamma_0\Gamma_2\gamma_0)\text{Tr}[\Gamma_1 D^{be}(x, x)\Gamma_3 \\
& \quad \times S^{ee'}(x, 0)(\gamma_0\Gamma_3\gamma_0)D^{e'b'}(0, 0)(\gamma_0\Gamma_1\gamma_0)U^{aa'T}(x, 0)] \\
& + \Gamma_2 D^{cb'}(x, 0)(\gamma_0\Gamma_1\gamma_0)U^{aa'T}(x, 0)\Gamma_1 D^{be}(x, x)\Gamma_3 \\
& \quad \times S^{ee'}(x, 0)(\gamma_0\Gamma_3\gamma_0)D^{e'c'}(0, 0)(\gamma_0\Gamma_2\gamma_0) \\
& + \Gamma_2 D^{ce}(x, x)\Gamma_3 S^{ee'}(x, 0)(\gamma_0\Gamma_3\gamma_0)D^{e'b'}(0, 0)(\gamma_0\Gamma_1\gamma_0) \\
& \quad \times U^{aa'T}(x, 0)\Gamma_1 D^{bc'}(x, 0)(\gamma_0\Gamma_2\gamma_0) \\
& - \Gamma_2 D^{cb'}(x, 0)(\gamma_0\Gamma_1\gamma_0)U^{aa'T}(x, 0)\Gamma_1 D^{bc'}(x, 0)(\gamma_0\Gamma_2\gamma_0) \\
& \quad \times \text{Tr}[\Gamma_3 S^{ee'}(x, 0)(\gamma_0\Gamma_3\gamma_0)D^{e'e}(0, x)] \\
& - \Gamma_2 D^{ce}(x, x)\Gamma_3 S^{ee'}(x, 0)(\gamma_0\Gamma_3\gamma_0)D^{e'c'}(0, 0)(\gamma_0\Gamma_2\gamma_0) \\
& \quad \times \text{Tr}[\Gamma_1 D^{bb'}(x, 0)(\gamma_0\Gamma_1\gamma_0)U^{aa'T}(x, 0)] \\
& + \Gamma_2 D^{cc'}(x, 0)(\gamma_0\Gamma_2\gamma_0)\text{Tr}[\Gamma_1 D^{bb'}(x, 0)(\gamma_0\Gamma_1\gamma_0) \\
& \quad \times U^{aa'T}(x, 0)]\text{Tr}[\Gamma_3 S^{ee'}(x, 0)(\gamma_0\Gamma_3\gamma_0)D^{e'e}(0, x)] \\
& + \Gamma_2 D^{cb'}(x, 0)(\gamma_0\Gamma_1\gamma_0)U^{e'a'T}(0, 0)(\gamma_0\Gamma_3\gamma_0)^T S^{ee'T}(x, 0)\Gamma_3^T \\
& \quad \times D^{beT}(x, x)\Gamma_1^T U^{ac'}(x, 0)(\gamma_0\Gamma_2\gamma_0) \\
& - \Gamma_2 D^{cb'}(x, 0)(\gamma_0\Gamma_1\gamma_0)U^{aa'T}(x, 0)\Gamma_1 D^{be}(x, x)\Gamma_3 \\
& \quad \times S^{ee'}(x, 0)(\gamma_0\Gamma_3\gamma_0)U^{e'c'}(0, 0)(\gamma_0\Gamma_2\gamma_0) \\
& - \Gamma_2 D^{ce}(x, x)\Gamma_3 S^{ee'}(x, 0)(\gamma_0\Gamma_3\gamma_0)U^{e'a'}(0, 0)(\gamma_0\Gamma_1\gamma_0)^T \\
& \quad \times D^{bb'T}(x, 0)\Gamma_1^T U^{ac'}(x, 0)(\gamma_0\Gamma_2\gamma_0) \\
& + \Gamma_2 D^{ce}(x, x)\Gamma_3 S^{ee'}(x, 0)(\gamma_0\Gamma_3\gamma_0)U^{e'c'}(0, 0)(\gamma_0\Gamma_2\gamma_0) \\
& \quad \times \text{Tr}[\Gamma_1 D^{bb'}(x, 0)(\gamma_0\Gamma_1\gamma_0)U^{aa'T}(x, 0)] \tag{F.2}
\end{aligned}$$

$$\begin{aligned}
\mathcal{G}_2^{\Lambda^1}(t, \vec{p}) &= \sum_{\vec{x}} e^{-i\vec{p}\cdot\vec{x}} \epsilon^{abc} \epsilon^{a'b'c'} \left[ \right. \\
& \quad \left. + \Gamma_2 S^{cc'}(x, 0)(\gamma_0\Gamma_2\gamma_0)\text{Tr}[\Gamma_1 D^{bb'}(x, 0)(\gamma_0\Gamma_1\gamma_0) \right.
\end{aligned}$$



$$\begin{aligned}
& \times U^{e'a'T}(0,0)(\gamma_0\Gamma_3\gamma_0)^T U^{ee'T}(x,0)\Gamma_3^T U^{ae'T}(x,x)] \\
& - \Gamma_2 S^{cc'}(x,0)(\gamma_0\Gamma_2\gamma_0)\text{Tr}[\Gamma_1 D^{bb'}(x,0)(\gamma_0\Gamma_1\gamma_0) \\
& \quad \times U^{ea'T}(x,0)\Gamma_3^T U^{ae'T}(x,x)]\text{Tr}[(\gamma_0\Gamma_3\gamma_0)U^{e'e'}(0,0)] \\
& - \Gamma_2 S^{cc'}(x,0)(\gamma_0\Gamma_2\gamma_0)\text{Tr}[\Gamma_1 D^{bb'}(x,0)(\gamma_0\Gamma_1\gamma_0) \\
& \quad \times U^{e'a'T}(0,0)(\gamma_0\Gamma_3\gamma_0)^T U^{ae'T}(x,0)]\text{Tr}[\Gamma_3 U^{ee}(x,x)] \\
& + \Gamma_2 S^{cc'}(x,0)(\gamma_0\Gamma_2\gamma_0)\text{Tr}[\Gamma_1 D^{bb'}(x,0)(\gamma_0\Gamma_1\gamma_0) \\
& \quad \times U^{ea'T}(x,0)\Gamma_3^T U^{e'e'T}(0,x)(\gamma_0\Gamma_3\gamma_0)^T U^{ae'T}(x,0)] \\
& + \Gamma_2 S^{cc'}(x,0)(\gamma_0\Gamma_2\gamma_0)\text{Tr}[\Gamma_1 D^{bb'}(x,0)(\gamma_0\Gamma_1\gamma_0) \\
& \quad \times U^{aa'T}(x,0)]\text{Tr}[\Gamma_3 U^{ee}(x,x)]\text{Tr}[(\gamma_0\Gamma_3\gamma_0)U^{e'e'}(0,0)] \\
& - \Gamma_2 S^{cc'}(x,0)(\gamma_0\Gamma_2\gamma_0)\text{Tr}[\Gamma_1 D^{bb'}(x,0)(\gamma_0\Gamma_1\gamma_0) \\
& \quad \times U^{aa'T}(x,0)]\text{Tr}[\Gamma_3 U^{ee'}(x,0)(\gamma_0\Gamma_3\gamma_0)U^{e'e}(0,x)] \\
& + \Gamma_2 S^{cb'}(x,0)(\gamma_0\Gamma_1\gamma_0)U^{e'a'T}(0,0)(\gamma_0\Gamma_3\gamma_0)^T U^{ee'T}(x,0)\Gamma_3^T \\
& \quad \times U^{ae'T}(x,x)\Gamma_1 D^{bc'}(x,0)(\gamma_0\Gamma_2\gamma_0) \\
& - \Gamma_2 S^{cb'}(x,0)(\gamma_0\Gamma_1\gamma_0)U^{ea'T}(x,0)\Gamma_3^T U^{ae'T}(x,x)\Gamma_1 \\
& \quad \times D^{bc'}(x,0)(\gamma_0\Gamma_2\gamma_0)\text{Tr}[(\gamma_0\Gamma_3\gamma_0)U^{e'e'}(0,0)] \\
& - \Gamma_2 S^{cb'}(x,0)(\gamma_0\Gamma_1\gamma_0)U^{e'a'T}(0,0)(\gamma_0\Gamma_3\gamma_0)^T U^{ae'T}(x,0)\Gamma_1 \\
& \quad \times D^{bc'}(x,0)(\gamma_0\Gamma_2\gamma_0)\text{Tr}[\Gamma_3 U^{ee}(x,x)] \\
& + \Gamma_2 S^{cb'}(x,0)(\gamma_0\Gamma_1\gamma_0)U^{ea'T}(x,0)\Gamma_3^T U^{e'e'T}(0,x)(\gamma_0\Gamma_3\gamma_0)^T \\
& \quad \times U^{ae'T}(x,0)\Gamma_1 D^{bc'}(x,0)(\gamma_0\Gamma_2\gamma_0) \\
& + \Gamma_2 S^{cb'}(x,0)(\gamma_0\Gamma_1\gamma_0)U^{aa'T}(x,0)\Gamma_1 D^{bc'}(x,0)(\gamma_0\Gamma_2\gamma_0) \\
& \quad \times \text{Tr}[\Gamma_3 U^{ee}(x,x)]\text{Tr}[(\gamma_0\Gamma_3\gamma_0)U^{e'e'}(0,0)] \\
& - \Gamma_2 S^{cb'}(x,0)(\gamma_0\Gamma_1\gamma_0)U^{aa'T}(x,0)\Gamma_1 D^{bc'}(x,0)(\gamma_0\Gamma_2\gamma_0) \\
& \quad \times \text{Tr}[\Gamma_3 U^{ee'}(x,0)(\gamma_0\Gamma_3\gamma_0)U^{e'e}(0,x)] \\
& + \Gamma_2 S^{cb'}(x,0)(\gamma_0\Gamma_1\gamma_0)D^{ba'T}(x,0)\Gamma_1^T U^{ae}(x,x)\Gamma_3 \\
& \quad \times U^{ee'}(x,0)(\gamma_0\Gamma_3\gamma_0)U^{e'e'}(0,0)(\gamma_0\Gamma_2\gamma_0) \\
& - \Gamma_2 S^{cb'}(x,0)(\gamma_0\Gamma_1\gamma_0)D^{ba'T}(x,0)\Gamma_1^T U^{ae}(x,x)\Gamma_3 \\
& \quad \times U^{ec'}(x,0)(\gamma_0\Gamma_2\gamma_0)\text{Tr}[(\gamma_0\Gamma_3\gamma_0)U^{e'e'}(0,0)] \\
& - \Gamma_2 S^{cb'}(x,0)(\gamma_0\Gamma_1\gamma_0)D^{ba'T}(x,0)\Gamma_1^T U^{ae'}(x,0)(\gamma_0\Gamma_3\gamma_0) \\
& \quad \times U^{e'e'}(0,0)(\gamma_0\Gamma_2\gamma_0)\text{Tr}[\Gamma_3 U^{ee}(x,x)] \\
& + \Gamma_2 S^{cb'}(x,0)(\gamma_0\Gamma_1\gamma_0)D^{ba'T}(x,0)\Gamma_1^T U^{ae'}(x,0)(\gamma_0\Gamma_3\gamma_0) \\
& \quad \times U^{e'e}(0,x)\Gamma_3 U^{ec'}(x,0)(\gamma_0\Gamma_2\gamma_0)
\end{aligned}$$

$$\begin{aligned}
& + \Gamma_2 S^{cb'}(x, 0)(\gamma_0 \Gamma_1 \gamma_0) D^{ba'T}(x, 0) \Gamma_1^T U^{ac'}(x, 0)(\gamma_0 \Gamma_2 \gamma_0) \\
& \quad \times \text{Tr}[\Gamma_3 U^{ee}(x, x)] \text{Tr}[(\gamma_0 \Gamma_3 \gamma_0) U^{e'e'}(0, 0)] \\
& - \Gamma_2 S^{cb'}(x, 0)(\gamma_0 \Gamma_1 \gamma_0) D^{ba'T}(x, 0) \Gamma_1^T U^{ac'}(x, 0)(\gamma_0 \Gamma_2 \gamma_0) \\
& \quad \times \text{Tr}[\Gamma_3 U^{ee'}(x, 0)(\gamma_0 \Gamma_3 \gamma_0) U^{e'e}(0, x)] \\
& + \Gamma_2 S^{cc'}(x, 0)(\gamma_0 \Gamma_2 \gamma_0) \text{Tr}[\Gamma_1 D^{be'}(x, 0)(\gamma_0 \Gamma_3 \gamma_0) \\
& \quad \times D^{e'b'}(0, 0)(\gamma_0 \Gamma_1 \gamma_0) U^{ea'T}(x, 0) \Gamma_3^T U^{ae^T}(x, x)] \\
& - \Gamma_2 S^{cc'}(x, 0)(\gamma_0 \Gamma_2 \gamma_0) \text{Tr}[\Gamma_1 D^{be'}(x, 0)(\gamma_0 \Gamma_3 \gamma_0) \\
& \quad \times D^{e'b'}(0, 0)(\gamma_0 \Gamma_1 \gamma_0) U^{aa'T}(x, 0)] \text{Tr}[\Gamma_3 U^{ee}(x, x)] \\
& - \Gamma_2 S^{cc'}(x, 0)(\gamma_0 \Gamma_2 \gamma_0) \text{Tr}[\Gamma_1 D^{bb'}(x, 0)(\gamma_0 \Gamma_1 \gamma_0) \\
& \quad \times U^{ea'T}(x, 0) \Gamma_3^T U^{ae^T}(x, x)] \text{Tr}[(\gamma_0 \Gamma_3 \gamma_0) D^{e'e'}(0, 0)] \\
& + \Gamma_2 S^{cc'}(x, 0)(\gamma_0 \Gamma_2 \gamma_0) \text{Tr}[\Gamma_1 D^{bb'}(x, 0)(\gamma_0 \Gamma_1 \gamma_0) \\
& \quad \times U^{aa'T}(x, 0)] \text{Tr}[\Gamma_3 U^{ee}(x, x)] \text{Tr}[(\gamma_0 \Gamma_3 \gamma_0) D^{e'e'}(0, 0)] \\
& + \Gamma_2 S^{cb'}(x, 0)(\gamma_0 \Gamma_1 \gamma_0) U^{ea'T}(x, 0) \Gamma_3^T U^{ae^T}(x, x) \Gamma_1 \\
& \quad \times D^{be'}(x, 0)(\gamma_0 \Gamma_3 \gamma_0) D^{e'e'}(0, 0)(\gamma_0 \Gamma_2 \gamma_0) \\
& - \Gamma_2 S^{cb'}(x, 0)(\gamma_0 \Gamma_1 \gamma_0) U^{aa'T}(x, 0) \Gamma_1 D^{be'}(x, 0)(\gamma_0 \Gamma_3 \gamma_0) \\
& \quad \times D^{e'e'}(0, 0)(\gamma_0 \Gamma_2 \gamma_0) \text{Tr}[\Gamma_3 U^{ee}(x, x)] \\
& - \Gamma_2 S^{cb'}(x, 0)(\gamma_0 \Gamma_1 \gamma_0) U^{ea'T}(x, 0) \Gamma_3^T U^{ae^T}(x, x) \Gamma_1 \\
& \quad \times D^{bc'}(x, 0)(\gamma_0 \Gamma_2 \gamma_0) \text{Tr}[(\gamma_0 \Gamma_3 \gamma_0) D^{e'e'}(0, 0)] \\
& + \Gamma_2 S^{cb'}(x, 0)(\gamma_0 \Gamma_1 \gamma_0) U^{aa'T}(x, 0) \Gamma_1 D^{bc'}(x, 0)(\gamma_0 \Gamma_2 \gamma_0) \\
& \quad \times \text{Tr}[\Gamma_3 U^{ee}(x, x)] \text{Tr}[(\gamma_0 \Gamma_3 \gamma_0) D^{e'e'}(0, 0)] \\
& + \Gamma_2 S^{cb'}(x, 0)(\gamma_0 \Gamma_1 \gamma_0) D^{e'a'T}(0, 0)(\gamma_0 \Gamma_3 \gamma_0)^T D^{be'T}(x, 0) \Gamma_1^T \\
& \quad \times U^{ae}(x, x) \Gamma_3 U^{ec'}(x, 0)(\gamma_0 \Gamma_2 \gamma_0) \\
& - \Gamma_2 S^{cb'}(x, 0)(\gamma_0 \Gamma_1 \gamma_0) D^{e'a'T}(0, 0)(\gamma_0 \Gamma_3 \gamma_0)^T D^{be'T}(x, 0) \Gamma_1^T \\
& \quad \times U^{ac'}(x, 0)(\gamma_0 \Gamma_2 \gamma_0) \text{Tr}[\Gamma_3 U^{ee}(x, x)] \\
& - \Gamma_2 S^{cb'}(x, 0)(\gamma_0 \Gamma_1 \gamma_0) D^{ba'T}(x, 0) \Gamma_1^T U^{ae}(x, x) \Gamma_3 \\
& \quad \times U^{ec'}(x, 0)(\gamma_0 \Gamma_2 \gamma_0) \text{Tr}[(\gamma_0 \Gamma_3 \gamma_0) D^{e'e'}(0, 0)] \\
& + \Gamma_2 S^{cb'}(x, 0)(\gamma_0 \Gamma_1 \gamma_0) D^{ba'T}(x, 0) \Gamma_1^T U^{ac'}(x, 0)(\gamma_0 \Gamma_2 \gamma_0) \\
& \quad \times \text{Tr}[\Gamma_3 U^{ee}(x, x)] \text{Tr}[(\gamma_0 \Gamma_3 \gamma_0) D^{e'e'}(0, 0)] \\
& + \Gamma_2 S^{ce'}(x, 0)(\gamma_0 \Gamma_3 \gamma_0) S^{e'e'}(0, 0)(\gamma_0 \Gamma_2 \gamma_0) \text{Tr}[\Gamma_1 \\
& \quad \times D^{bb'}(x, 0)(\gamma_0 \Gamma_1 \gamma_0) U^{ea'T}(x, 0) \Gamma_3^T U^{ae^T}(x, x)] \\
& - \Gamma_2 S^{ce'}(x, 0)(\gamma_0 \Gamma_3 \gamma_0) S^{e'e'}(0, 0)(\gamma_0 \Gamma_2 \gamma_0) \text{Tr}[\Gamma_1
\end{aligned}$$

$$\begin{aligned}
& \times D^{bb'}(x, 0)(\gamma_0 \Gamma_1 \gamma_0) U^{aa'T}(x, 0) \text{Tr}[\Gamma_3 U^{ee}(x, x)] \\
& - \Gamma_2 S^{cc'}(x, 0)(\gamma_0 \Gamma_2 \gamma_0) \text{Tr}[\Gamma_1 D^{bb'}(x, 0)(\gamma_0 \Gamma_1 \gamma_0) \\
& \quad \times U^{ea'T}(x, 0) \Gamma_3^T U^{ae'T}(x, x)] \text{Tr}[(\gamma_0 \Gamma_3 \gamma_0) S^{e'e'}(0, 0)] \\
& + \Gamma_2 S^{cc'}(x, 0)(\gamma_0 \Gamma_2 \gamma_0) \text{Tr}[\Gamma_1 D^{bb'}(x, 0)(\gamma_0 \Gamma_1 \gamma_0) \\
& \quad \times U^{aa'T}(x, 0)] \text{Tr}[\Gamma_3 U^{ee}(x, x)] \text{Tr}[(\gamma_0 \Gamma_3 \gamma_0) S^{e'e'}(0, 0)] \\
& + \Gamma_2 S^{cc'}(x, 0)(\gamma_0 \Gamma_3 \gamma_0) S^{e'b'}(0, 0)(\gamma_0 \Gamma_1 \gamma_0) U^{ea'T}(x, 0) \Gamma_3^T \\
& \quad \times U^{ae'T}(x, x) \Gamma_1 D^{bc'}(x, 0)(\gamma_0 \Gamma_2 \gamma_0) \\
& - \Gamma_2 S^{cc'}(x, 0)(\gamma_0 \Gamma_3 \gamma_0) S^{e'b'}(0, 0)(\gamma_0 \Gamma_1 \gamma_0) U^{aa'T}(x, 0) \Gamma_1 \\
& \quad \times D^{bc'}(x, 0)(\gamma_0 \Gamma_2 \gamma_0) \text{Tr}[\Gamma_3 U^{ee}(x, x)] \\
& - \Gamma_2 S^{cb'}(x, 0)(\gamma_0 \Gamma_1 \gamma_0) U^{ea'T}(x, 0) \Gamma_3^T U^{ae'T}(x, x) \Gamma_1 \\
& \quad \times D^{bc'}(x, 0)(\gamma_0 \Gamma_2 \gamma_0) \text{Tr}[(\gamma_0 \Gamma_3 \gamma_0) S^{e'e'}(0, 0)] \\
& + \Gamma_2 S^{cb'}(x, 0)(\gamma_0 \Gamma_1 \gamma_0) U^{aa'T}(x, 0) \Gamma_1 D^{bc'}(x, 0)(\gamma_0 \Gamma_2 \gamma_0) \\
& \quad \times \text{Tr}[\Gamma_3 U^{ee}(x, x)] \text{Tr}[(\gamma_0 \Gamma_3 \gamma_0) S^{e'e'}(0, 0)] \\
& + \Gamma_2 S^{cc'}(x, 0)(\gamma_0 \Gamma_3 \gamma_0) S^{e'b'}(0, 0)(\gamma_0 \Gamma_1 \gamma_0) D^{ba'T}(x, 0) \Gamma_1^T \\
& \quad \times U^{ae}(x, x) \Gamma_3 U^{ec'}(x, 0)(\gamma_0 \Gamma_2 \gamma_0) \\
& - \Gamma_2 S^{cc'}(x, 0)(\gamma_0 \Gamma_3 \gamma_0) S^{e'b'}(0, 0)(\gamma_0 \Gamma_1 \gamma_0) D^{ba'T}(x, 0) \Gamma_1^T \\
& \quad \times U^{ac'}(x, 0)(\gamma_0 \Gamma_2 \gamma_0) \text{Tr}[\Gamma_3 U^{ee}(x, x)] \\
& - \Gamma_2 S^{cb'}(x, 0)(\gamma_0 \Gamma_1 \gamma_0) D^{ba'T}(x, 0) \Gamma_1^T U^{ae}(x, x) \Gamma_3 \\
& \quad \times U^{ec'}(x, 0)(\gamma_0 \Gamma_2 \gamma_0) \text{Tr}[(\gamma_0 \Gamma_3 \gamma_0) S^{e'e'}(0, 0)] \\
& + \Gamma_2 S^{cb'}(x, 0)(\gamma_0 \Gamma_1 \gamma_0) D^{ba'T}(x, 0) \Gamma_1^T U^{ac'}(x, 0)(\gamma_0 \Gamma_2 \gamma_0) \\
& \quad \times \text{Tr}[\Gamma_3 U^{ee}(x, x)] \text{Tr}[(\gamma_0 \Gamma_3 \gamma_0) S^{e'e'}(0, 0)] \\
& + \Gamma_2 D^{cb'}(x, 0)(\gamma_0 \Gamma_1 \gamma_0) U^{e'a'T}(0, 0)(\gamma_0 \Gamma_3 \gamma_0)^T U^{ee'T}(x, 0) \Gamma_3^T \\
& \quad \times U^{ae'T}(x, x) \Gamma_1 S^{bc'}(x, 0)(\gamma_0 \Gamma_2 \gamma_0) \\
& - \Gamma_2 D^{cb'}(x, 0)(\gamma_0 \Gamma_1 \gamma_0) U^{ea'T}(x, 0) \Gamma_3^T U^{ae'T}(x, x) \Gamma_1 \\
& \quad \times S^{bc'}(x, 0)(\gamma_0 \Gamma_2 \gamma_0) \text{Tr}[(\gamma_0 \Gamma_3 \gamma_0) U^{e'e'}(0, 0)] \\
& - \Gamma_2 D^{cb'}(x, 0)(\gamma_0 \Gamma_1 \gamma_0) U^{e'a'T}(0, 0)(\gamma_0 \Gamma_3 \gamma_0)^T U^{ae'T}(x, 0) \Gamma_1 \\
& \quad \times S^{bc'}(x, 0)(\gamma_0 \Gamma_2 \gamma_0) \text{Tr}[\Gamma_3 U^{ee}(x, x)] \\
& + \Gamma_2 D^{cb'}(x, 0)(\gamma_0 \Gamma_1 \gamma_0) U^{ea'T}(x, 0) \Gamma_3^T U^{e'e'T}(0, x)(\gamma_0 \Gamma_3 \gamma_0)^T \\
& \quad \times U^{ae'T}(x, 0) \Gamma_1 S^{bc'}(x, 0)(\gamma_0 \Gamma_2 \gamma_0) \\
& + \Gamma_2 D^{cb'}(x, 0)(\gamma_0 \Gamma_1 \gamma_0) U^{aa'T}(x, 0) \Gamma_1 S^{bc'}(x, 0)(\gamma_0 \Gamma_2 \gamma_0) \\
& \quad \times \text{Tr}[\Gamma_3 U^{ee}(x, x)] \text{Tr}[(\gamma_0 \Gamma_3 \gamma_0) U^{e'e'}(0, 0)]
\end{aligned}$$

$$\begin{aligned}
& - \Gamma_2 D^{cb'}(x, 0)(\gamma_0 \Gamma_1 \gamma_0) U^{aa'T}(x, 0) \Gamma_1 S^{bc'}(x, 0)(\gamma_0 \Gamma_2 \gamma_0) \\
& \quad \times \text{Tr}[\Gamma_3 U^{ee'}(x, 0)(\gamma_0 \Gamma_3 \gamma_0) U^{e'e}(0, x)] \\
& + \Gamma_2 D^{cc'}(x, 0)(\gamma_0 \Gamma_2 \gamma_0) \text{Tr}[\Gamma_1 S^{bb'}(x, 0)(\gamma_0 \Gamma_1 \gamma_0) \\
& \quad \times U^{e'a'T}(0, 0)(\gamma_0 \Gamma_3 \gamma_0)^T U^{ee'T}(x, 0) \Gamma_3^T U^{ae'T}(x, x)] \\
& - \Gamma_2 D^{cc'}(x, 0)(\gamma_0 \Gamma_2 \gamma_0) \text{Tr}[\Gamma_1 S^{bb'}(x, 0)(\gamma_0 \Gamma_1 \gamma_0) \\
& \quad \times U^{ea'T}(x, 0) \Gamma_3^T U^{ae'T}(x, x)] \text{Tr}[(\gamma_0 \Gamma_3 \gamma_0) U^{e'e'}(0, 0)] \\
& - \Gamma_2 D^{cc'}(x, 0)(\gamma_0 \Gamma_2 \gamma_0) \text{Tr}[\Gamma_1 S^{bb'}(x, 0)(\gamma_0 \Gamma_1 \gamma_0) \\
& \quad \times U^{e'a'T}(0, 0)(\gamma_0 \Gamma_3 \gamma_0)^T U^{ae'T}(x, 0)] \text{Tr}[\Gamma_3 U^{ee}(x, x)] \\
& + \Gamma_2 D^{cc'}(x, 0)(\gamma_0 \Gamma_2 \gamma_0) \text{Tr}[\Gamma_1 S^{bb'}(x, 0)(\gamma_0 \Gamma_1 \gamma_0) \\
& \quad \times U^{ea'T}(x, 0) \Gamma_3^T U^{e'e'T}(0, x)(\gamma_0 \Gamma_3 \gamma_0)^T U^{ae'T}(x, 0)] \\
& + \Gamma_2 D^{cc'}(x, 0)(\gamma_0 \Gamma_2 \gamma_0) \text{Tr}[\Gamma_1 S^{bb'}(x, 0)(\gamma_0 \Gamma_1 \gamma_0) \\
& \quad \times U^{aa'T}(x, 0)] \text{Tr}[\Gamma_3 U^{ee}(x, x)] \text{Tr}[(\gamma_0 \Gamma_3 \gamma_0) U^{e'e'}(0, 0)] \\
& - \Gamma_2 D^{cc'}(x, 0)(\gamma_0 \Gamma_2 \gamma_0) \text{Tr}[\Gamma_1 S^{bb'}(x, 0)(\gamma_0 \Gamma_1 \gamma_0) \\
& \quad \times U^{aa'T}(x, 0)] \text{Tr}[\Gamma_3 U^{ee'}(x, 0)(\gamma_0 \Gamma_3 \gamma_0) U^{e'e}(0, x)] \\
& + \Gamma_2 D^{ca'}(x, 0)(\gamma_0 \Gamma_1 \gamma_0)^T S^{bb'T}(x, 0) \Gamma_1^T U^{ae}(x, x) \Gamma_3 \\
& \quad \times U^{ee'}(x, 0)(\gamma_0 \Gamma_3 \gamma_0) U^{e'c'}(0, 0)(\gamma_0 \Gamma_2 \gamma_0) \\
& - \Gamma_2 D^{ca'}(x, 0)(\gamma_0 \Gamma_1 \gamma_0)^T S^{bb'T}(x, 0) \Gamma_1^T U^{ae}(x, x) \Gamma_3 \\
& \quad \times U^{ec'}(x, 0)(\gamma_0 \Gamma_2 \gamma_0) \text{Tr}[(\gamma_0 \Gamma_3 \gamma_0) U^{e'e'}(0, 0)] \\
& - \Gamma_2 D^{ca'}(x, 0)(\gamma_0 \Gamma_1 \gamma_0)^T S^{bb'T}(x, 0) \Gamma_1^T U^{ae'}(x, 0)(\gamma_0 \Gamma_3 \gamma_0) \\
& \quad \times U^{e'c'}(0, 0)(\gamma_0 \Gamma_2 \gamma_0) \text{Tr}[\Gamma_3 U^{ee}(x, x)] \\
& + \Gamma_2 D^{ca'}(x, 0)(\gamma_0 \Gamma_1 \gamma_0)^T S^{bb'T}(x, 0) \Gamma_1^T U^{ae'}(x, 0)(\gamma_0 \Gamma_3 \gamma_0) \\
& \quad \times U^{e'e}(0, x) \Gamma_3 U^{ec'}(x, 0)(\gamma_0 \Gamma_2 \gamma_0) \\
& + \Gamma_2 D^{ca'}(x, 0)(\gamma_0 \Gamma_1 \gamma_0)^T S^{bb'T}(x, 0) \Gamma_1^T U^{ac'}(x, 0)(\gamma_0 \Gamma_2 \gamma_0) \\
& \quad \times \text{Tr}[\Gamma_3 U^{ee}(x, x)] \text{Tr}[(\gamma_0 \Gamma_3 \gamma_0) U^{e'e'}(0, 0)] \\
& - \Gamma_2 D^{ca'}(x, 0)(\gamma_0 \Gamma_1 \gamma_0)^T S^{bb'T}(x, 0) \Gamma_1^T U^{ac'}(x, 0)(\gamma_0 \Gamma_2 \gamma_0) \\
& \quad \times \text{Tr}[\Gamma_3 U^{ee'}(x, 0)(\gamma_0 \Gamma_3 \gamma_0) U^{e'e}(0, x)] \\
& + \Gamma_2 D^{ce'}(x, 0)(\gamma_0 \Gamma_3 \gamma_0) D^{e'b'}(0, 0)(\gamma_0 \Gamma_1 \gamma_0) U^{ea'T}(x, 0) \Gamma_3^T \\
& \quad \times U^{ae'T}(x, x) \Gamma_1 S^{bc'}(x, 0)(\gamma_0 \Gamma_2 \gamma_0) \\
& - \Gamma_2 D^{ce'}(x, 0)(\gamma_0 \Gamma_3 \gamma_0) D^{e'b'}(0, 0)(\gamma_0 \Gamma_1 \gamma_0) U^{aa'T}(x, 0) \Gamma_1 \\
& \quad \times S^{bc'}(x, 0)(\gamma_0 \Gamma_2 \gamma_0) \text{Tr}[\Gamma_3 U^{ee}(x, x)] \\
& - \Gamma_2 D^{cb'}(x, 0)(\gamma_0 \Gamma_1 \gamma_0) U^{ea'T}(x, 0) \Gamma_3^T U^{ae'T}(x, x) \Gamma_1
\end{aligned}$$

$$\begin{aligned}
& \times S^{bc'}(x, 0)(\gamma_0 \Gamma_2 \gamma_0) \text{Tr}[(\gamma_0 \Gamma_3 \gamma_0) D^{e'e'}(0, 0)] \\
& + \Gamma_2 D^{cb'}(x, 0)(\gamma_0 \Gamma_1 \gamma_0) U^{aa'T}(x, 0) \Gamma_1 S^{bc'}(x, 0)(\gamma_0 \Gamma_2 \gamma_0) \\
& \quad \times \text{Tr}[\Gamma_3 U^{ee}(x, x)] \text{Tr}[(\gamma_0 \Gamma_3 \gamma_0) D^{e'e'}(0, 0)] \\
& + \Gamma_2 D^{ce'}(x, 0)(\gamma_0 \Gamma_3 \gamma_0) D^{e'e'}(0, 0)(\gamma_0 \Gamma_2 \gamma_0) \text{Tr}[\Gamma_1 \\
& \quad \times S^{bb'}(x, 0)(\gamma_0 \Gamma_1 \gamma_0) U^{ea'T}(x, 0) \Gamma_3^T U^{aeT}(x, x)] \\
& - \Gamma_2 D^{ce'}(x, 0)(\gamma_0 \Gamma_3 \gamma_0) D^{e'e'}(0, 0)(\gamma_0 \Gamma_2 \gamma_0) \text{Tr}[\Gamma_1 \\
& \quad \times S^{bb'}(x, 0)(\gamma_0 \Gamma_1 \gamma_0) U^{aa'T}(x, 0)] \text{Tr}[\Gamma_3 U^{ee}(x, x)] \\
& - \Gamma_2 D^{cc'}(x, 0)(\gamma_0 \Gamma_2 \gamma_0) \text{Tr}[\Gamma_1 S^{bb'}(x, 0)(\gamma_0 \Gamma_1 \gamma_0) \\
& \quad \times U^{ea'T}(x, 0) \Gamma_3^T U^{aeT}(x, x)] \text{Tr}[(\gamma_0 \Gamma_3 \gamma_0) D^{e'e'}(0, 0)] \\
& + \Gamma_2 D^{cc'}(x, 0)(\gamma_0 \Gamma_2 \gamma_0) \text{Tr}[\Gamma_1 S^{bb'}(x, 0)(\gamma_0 \Gamma_1 \gamma_0) \\
& \quad \times U^{aa'T}(x, 0)] \text{Tr}[\Gamma_3 U^{ee}(x, x)] \text{Tr}[(\gamma_0 \Gamma_3 \gamma_0) D^{e'e'}(0, 0)] \\
& + \Gamma_2 D^{ce'}(x, 0)(\gamma_0 \Gamma_3 \gamma_0) D^{e'a'}(0, 0)(\gamma_0 \Gamma_1 \gamma_0)^T S^{bb'T}(x, 0) \Gamma_1^T \\
& \quad \times U^{ae}(x, x) \Gamma_3 U^{ec'}(x, 0)(\gamma_0 \Gamma_2 \gamma_0) \\
& - \Gamma_2 D^{ce'}(x, 0)(\gamma_0 \Gamma_3 \gamma_0) D^{e'a'}(0, 0)(\gamma_0 \Gamma_1 \gamma_0)^T S^{bb'T}(x, 0) \Gamma_1^T \\
& \quad \times U^{ac'}(x, 0)(\gamma_0 \Gamma_2 \gamma_0) \text{Tr}[\Gamma_3 U^{ee}(x, x)] \\
& - \Gamma_2 D^{ca'}(x, 0)(\gamma_0 \Gamma_1 \gamma_0)^T S^{bb'T}(x, 0) \Gamma_1^T U^{ae}(x, x) \Gamma_3 \\
& \quad \times U^{ec'}(x, 0)(\gamma_0 \Gamma_2 \gamma_0) \text{Tr}[(\gamma_0 \Gamma_3 \gamma_0) D^{e'e'}(0, 0)] \\
& + \Gamma_2 D^{ca'}(x, 0)(\gamma_0 \Gamma_1 \gamma_0)^T S^{bb'T}(x, 0) \Gamma_1^T U^{ac'}(x, 0)(\gamma_0 \Gamma_2 \gamma_0) \\
& \quad \times \text{Tr}[\Gamma_3 U^{ee}(x, x)] \text{Tr}[(\gamma_0 \Gamma_3 \gamma_0) D^{e'e'}(0, 0)] \\
& + \Gamma_2 D^{cb'}(x, 0)(\gamma_0 \Gamma_1 \gamma_0) U^{ea'T}(x, 0) \Gamma_3^T U^{aeT}(x, x) \Gamma_1 \\
& \quad \times S^{be'}(x, 0)(\gamma_0 \Gamma_3 \gamma_0) S^{e'e'}(0, 0)(\gamma_0 \Gamma_2 \gamma_0) \\
& - \Gamma_2 D^{cb'}(x, 0)(\gamma_0 \Gamma_1 \gamma_0) U^{aa'T}(x, 0) \Gamma_1 S^{be'}(x, 0)(\gamma_0 \Gamma_3 \gamma_0) \\
& \quad \times S^{e'e'}(0, 0)(\gamma_0 \Gamma_2 \gamma_0) \text{Tr}[\Gamma_3 U^{ee}(x, x)] \\
& - \Gamma_2 D^{cb'}(x, 0)(\gamma_0 \Gamma_1 \gamma_0) U^{ea'T}(x, 0) \Gamma_3^T U^{aeT}(x, x) \Gamma_1 \\
& \quad \times S^{bc'}(x, 0)(\gamma_0 \Gamma_2 \gamma_0) \text{Tr}[(\gamma_0 \Gamma_3 \gamma_0) S^{e'e'}(0, 0)] \\
& + \Gamma_2 D^{cb'}(x, 0)(\gamma_0 \Gamma_1 \gamma_0) U^{aa'T}(x, 0) \Gamma_1 S^{bc'}(x, 0)(\gamma_0 \Gamma_2 \gamma_0) \\
& \quad \times \text{Tr}[\Gamma_3 U^{ee}(x, x)] \text{Tr}[(\gamma_0 \Gamma_3 \gamma_0) S^{e'e'}(0, 0)] \\
& + \Gamma_2 D^{cc'}(x, 0)(\gamma_0 \Gamma_2 \gamma_0) \text{Tr}[\Gamma_1 S^{be'}(x, 0)(\gamma_0 \Gamma_3 \gamma_0) \\
& \quad \times S^{e'b'}(0, 0)(\gamma_0 \Gamma_1 \gamma_0) U^{ea'T}(x, 0) \Gamma_3^T U^{aeT}(x, x)] \\
& - \Gamma_2 D^{cc'}(x, 0)(\gamma_0 \Gamma_2 \gamma_0) \text{Tr}[\Gamma_1 S^{be'}(x, 0)(\gamma_0 \Gamma_3 \gamma_0) \\
& \quad \times S^{e'b'}(0, 0)(\gamma_0 \Gamma_1 \gamma_0) U^{aa'T}(x, 0)] \text{Tr}[\Gamma_3 U^{ee}(x, x)]
\end{aligned}$$

$$\begin{aligned}
& - \Gamma_2 D^{cc'}(x, 0)(\gamma_0 \Gamma_2 \gamma_0) \text{Tr} [\Gamma_1 S^{bb'}(x, 0)(\gamma_0 \Gamma_1 \gamma_0) \\
& \quad \times U^{ea'T}(x, 0) \Gamma_3^T U^{aeT}(x, x)] \text{Tr} [(\gamma_0 \Gamma_3 \gamma_0) S^{e'e'}(0, 0)] \\
& + \Gamma_2 D^{cc'}(x, 0)(\gamma_0 \Gamma_2 \gamma_0) \text{Tr} [\Gamma_1 S^{bb'}(x, 0)(\gamma_0 \Gamma_1 \gamma_0) \\
& \quad \times U^{aa'T}(x, 0)] \text{Tr} [\Gamma_3 U^{ee}(x, x)] \text{Tr} [(\gamma_0 \Gamma_3 \gamma_0) S^{e'e'}(0, 0)] \\
& + \Gamma_2 D^{ca'}(x, 0)(\gamma_0 \Gamma_1 \gamma_0)^T S^{e'b'T}(0, 0)(\gamma_0 \Gamma_3 \gamma_0)^T S^{be'T}(x, 0) \Gamma_1^T \\
& \quad \times U^{ae}(x, x) \Gamma_3 U^{ec'}(x, 0)(\gamma_0 \Gamma_2 \gamma_0) \\
& - \Gamma_2 D^{ca'}(x, 0)(\gamma_0 \Gamma_1 \gamma_0)^T S^{e'b'T}(0, 0)(\gamma_0 \Gamma_3 \gamma_0)^T S^{be'T}(x, 0) \Gamma_1^T \\
& \quad \times U^{ac'}(x, 0)(\gamma_0 \Gamma_2 \gamma_0) \text{Tr} [\Gamma_3 U^{ee}(x, x)] \\
& - \Gamma_2 D^{ca'}(x, 0)(\gamma_0 \Gamma_1 \gamma_0)^T S^{bb'T}(x, 0) \Gamma_1^T U^{ae}(x, x) \Gamma_3 \\
& \quad \times U^{ec'}(x, 0)(\gamma_0 \Gamma_2 \gamma_0) \text{Tr} [(\gamma_0 \Gamma_3 \gamma_0) S^{e'e'}(0, 0)] \\
& + \Gamma_2 D^{ca'}(x, 0)(\gamma_0 \Gamma_1 \gamma_0)^T S^{bb'T}(x, 0) \Gamma_1^T U^{ac'}(x, 0)(\gamma_0 \Gamma_2 \gamma_0) \\
& \quad \times \text{Tr} [\Gamma_3 U^{ee}(x, x)] \text{Tr} [(\gamma_0 \Gamma_3 \gamma_0) S^{e'e'}(0, 0)] \\
& + \Gamma_2 U^{ce}(x, x) \Gamma_3 U^{ee'}(x, 0)(\gamma_0 \Gamma_3 \gamma_0) U^{e'a'}(0, 0)(\gamma_0 \Gamma_1 \gamma_0)^T \\
& \quad \times D^{ab'T}(x, 0) \Gamma_1 S^{bc'}(x, 0)(\gamma_0 \Gamma_2 \gamma_0) \\
& - \Gamma_2 U^{ce}(x, x) \Gamma_3 U^{ea'}(x, 0)(\gamma_0 \Gamma_1 \gamma_0)^T D^{ab'T}(x, 0) \Gamma_1 \\
& \quad \times S^{bc'}(x, 0)(\gamma_0 \Gamma_2 \gamma_0) \text{Tr} [(\gamma_0 \Gamma_3 \gamma_0) U^{e'e'}(0, 0)] \\
& - \Gamma_2 U^{ce'}(x, 0)(\gamma_0 \Gamma_3 \gamma_0) U^{e'a'}(0, 0)(\gamma_0 \Gamma_1 \gamma_0)^T D^{ab'T}(x, 0) \Gamma_1 \\
& \quad \times S^{bc'}(x, 0)(\gamma_0 \Gamma_2 \gamma_0) \text{Tr} [\Gamma_3 U^{ee}(x, x)] \\
& + \Gamma_2 U^{ce'}(x, 0)(\gamma_0 \Gamma_3 \gamma_0) U^{e'e}(0, x) \Gamma_3 U^{ea'}(x, 0)(\gamma_0 \Gamma_1 \gamma_0)^T \\
& \quad \times D^{ab'T}(x, 0) \Gamma_1 S^{bc'}(x, 0)(\gamma_0 \Gamma_2 \gamma_0) \\
& + \Gamma_2 U^{ca'}(x, 0)(\gamma_0 \Gamma_1 \gamma_0)^T D^{ab'T}(x, 0) \Gamma_1 S^{bc'}(x, 0)(\gamma_0 \Gamma_2 \gamma_0) \\
& \quad \times \text{Tr} [\Gamma_3 U^{ee}(x, x)] \text{Tr} [(\gamma_0 \Gamma_3 \gamma_0) U^{e'e'}(0, 0)] \\
& - \Gamma_2 U^{ca'}(x, 0)(\gamma_0 \Gamma_1 \gamma_0)^T D^{ab'T}(x, 0) \Gamma_1 S^{bc'}(x, 0)(\gamma_0 \Gamma_2 \gamma_0) \\
& \quad \times \text{Tr} [\Gamma_3 U^{ee'}(x, 0)(\gamma_0 \Gamma_3 \gamma_0) U^{e'e}(0, x)] \\
& + \Gamma_2 U^{ce}(x, x) \Gamma_3 U^{ee'}(x, 0)(\gamma_0 \Gamma_3 \gamma_0) U^{e'a'}(0, 0)(\gamma_0 \Gamma_1 \gamma_0)^T \\
& \quad \times S^{bb'T}(x, 0) \Gamma_1^T D^{ac'}(x, 0)(\gamma_0 \Gamma_2 \gamma_0) \\
& - \Gamma_2 U^{ce}(x, x) \Gamma_3 U^{ea'}(x, 0)(\gamma_0 \Gamma_1 \gamma_0)^T S^{bb'T}(x, 0) \Gamma_1^T \\
& \quad \times D^{ac'}(x, 0)(\gamma_0 \Gamma_2 \gamma_0) \text{Tr} [(\gamma_0 \Gamma_3 \gamma_0) U^{e'e'}(0, 0)] \\
& - \Gamma_2 U^{ce'}(x, 0)(\gamma_0 \Gamma_3 \gamma_0) U^{e'a'}(0, 0)(\gamma_0 \Gamma_1 \gamma_0)^T S^{bb'T}(x, 0) \Gamma_1^T \\
& \quad \times D^{ac'}(x, 0)(\gamma_0 \Gamma_2 \gamma_0) \text{Tr} [\Gamma_3 U^{ee}(x, x)] \\
& + \Gamma_2 U^{ce'}(x, 0)(\gamma_0 \Gamma_3 \gamma_0) U^{e'e}(0, x) \Gamma_3 U^{ea'}(x, 0)(\gamma_0 \Gamma_1 \gamma_0)^T
\end{aligned}$$

$$\begin{aligned}
& \times S^{bb'T}(x, 0)\Gamma_1^T D^{ac'}(x, 0)(\gamma_0\Gamma_2\gamma_0) \\
& + \Gamma_2 U^{ca'}(x, 0)(\gamma_0\Gamma_1\gamma_0)^T S^{bb'T}(x, 0)\Gamma_1^T D^{ac'}(x, 0)(\gamma_0\Gamma_2\gamma_0) \\
& \quad \times \text{Tr}[\Gamma_3 U^{ee}(x, x)] \text{Tr}[(\gamma_0\Gamma_3\gamma_0)U^{e'e'}(0, 0)] \\
& - \Gamma_2 U^{ca'}(x, 0)(\gamma_0\Gamma_1\gamma_0)^T S^{bb'T}(x, 0)\Gamma_1^T D^{ac'}(x, 0)(\gamma_0\Gamma_2\gamma_0) \\
& \quad \times \text{Tr}[\Gamma_3 U^{ee'}(x, 0)(\gamma_0\Gamma_3\gamma_0)U^{e'e}(0, x)] \\
& + \Gamma_2 U^{ce}(x, x)\Gamma_3 U^{ee'}(x, 0)(\gamma_0\Gamma_3\gamma_0)U^{e'c'}(0, 0)(\gamma_0\Gamma_2\gamma_0) \\
& \quad \times \text{Tr}[\Gamma_1 S^{bb'}(x, 0)(\gamma_0\Gamma_1\gamma_0)D^{aa'T}(x, 0)] \\
& - \Gamma_2 U^{ce}(x, x)\Gamma_3 U^{e'c'}(x, 0)(\gamma_0\Gamma_2\gamma_0)\text{Tr}[\Gamma_1 \\
& \quad \times S^{bb'}(x, 0)(\gamma_0\Gamma_1\gamma_0)D^{aa'T}(x, 0)] \text{Tr}[(\gamma_0\Gamma_3\gamma_0)U^{e'e'}(0, 0)] \\
& - \Gamma_2 U^{ce'}(x, 0)(\gamma_0\Gamma_3\gamma_0)U^{e'c'}(0, 0)(\gamma_0\Gamma_2\gamma_0)\text{Tr}[\Gamma_1 \\
& \quad \times S^{bb'}(x, 0)(\gamma_0\Gamma_1\gamma_0)D^{aa'T}(x, 0)] \text{Tr}[\Gamma_3 U^{ee}(x, x)] \\
& + \Gamma_2 U^{ce'}(x, 0)(\gamma_0\Gamma_3\gamma_0)U^{e'e}(0, x)\Gamma_3 U^{e'c'}(x, 0)(\gamma_0\Gamma_2\gamma_0) \\
& \quad \times \text{Tr}[\Gamma_1 S^{bb'}(x, 0)(\gamma_0\Gamma_1\gamma_0)D^{aa'T}(x, 0)] \\
& + \Gamma_2 U^{cc'}(x, 0)(\gamma_0\Gamma_2\gamma_0)\text{Tr}[\Gamma_1 S^{bb'}(x, 0)(\gamma_0\Gamma_1\gamma_0) \\
& \quad \times D^{aa'T}(x, 0)] \text{Tr}[\Gamma_3 U^{ee}(x, x)] \text{Tr}[(\gamma_0\Gamma_3\gamma_0)U^{e'e'}(0, 0)] \\
& - \Gamma_2 U^{cc'}(x, 0)(\gamma_0\Gamma_2\gamma_0)\text{Tr}[\Gamma_1 S^{bb'}(x, 0)(\gamma_0\Gamma_1\gamma_0) \\
& \quad \times D^{aa'T}(x, 0)] \text{Tr}[\Gamma_3 U^{ee'}(x, 0)(\gamma_0\Gamma_3\gamma_0)U^{e'e}(0, x)] \\
& + \Gamma_2 U^{ce}(x, x)\Gamma_3 U^{ea'}(x, 0)(\gamma_0\Gamma_1\gamma_0)^T D^{e'b'T}(0, 0)(\gamma_0\Gamma_3\gamma_0)^T \\
& \quad \times D^{ae'T}(x, 0)\Gamma_1 S^{bc'}(x, 0)(\gamma_0\Gamma_2\gamma_0) \\
& - \Gamma_2 U^{ca'}(x, 0)(\gamma_0\Gamma_1\gamma_0)^T D^{e'b'T}(0, 0)(\gamma_0\Gamma_3\gamma_0)^T D^{ae'T}(x, 0)\Gamma_1 \\
& \quad \times S^{bc'}(x, 0)(\gamma_0\Gamma_2\gamma_0)\text{Tr}[\Gamma_3 U^{ee}(x, x)] \\
& - \Gamma_2 U^{ce}(x, x)\Gamma_3 U^{ea'}(x, 0)(\gamma_0\Gamma_1\gamma_0)^T D^{ab'T}(x, 0)\Gamma_1 \\
& \quad \times S^{bc'}(x, 0)(\gamma_0\Gamma_2\gamma_0)\text{Tr}[(\gamma_0\Gamma_3\gamma_0)D^{e'e'}(0, 0)] \\
& + \Gamma_2 U^{ca'}(x, 0)(\gamma_0\Gamma_1\gamma_0)^T D^{ab'T}(x, 0)\Gamma_1 S^{bc'}(x, 0)(\gamma_0\Gamma_2\gamma_0) \\
& \quad \times \text{Tr}[\Gamma_3 U^{ee}(x, x)] \text{Tr}[(\gamma_0\Gamma_3\gamma_0)D^{e'e'}(0, 0)] \\
& + \Gamma_2 U^{ce}(x, x)\Gamma_3 U^{ea'}(x, 0)(\gamma_0\Gamma_1\gamma_0)^T S^{bb'T}(x, 0)\Gamma_1^T \\
& \quad \times D^{ae'}(x, 0)(\gamma_0\Gamma_3\gamma_0)D^{e'c'}(0, 0)(\gamma_0\Gamma_2\gamma_0) \\
& - \Gamma_2 U^{ca'}(x, 0)(\gamma_0\Gamma_1\gamma_0)^T S^{bb'T}(x, 0)\Gamma_1^T D^{ae'}(x, 0)(\gamma_0\Gamma_3\gamma_0) \\
& \quad \times D^{e'c'}(0, 0)(\gamma_0\Gamma_2\gamma_0)\text{Tr}[\Gamma_3 U^{ee}(x, x)] \\
& - \Gamma_2 U^{ce}(x, x)\Gamma_3 U^{ea'}(x, 0)(\gamma_0\Gamma_1\gamma_0)^T S^{bb'T}(x, 0)\Gamma_1^T \\
& \quad \times D^{ac'}(x, 0)(\gamma_0\Gamma_2\gamma_0)\text{Tr}[(\gamma_0\Gamma_3\gamma_0)D^{e'e'}(0, 0)]
\end{aligned}$$

$$\begin{aligned}
& + \Gamma_2 U^{ca'}(x, 0)(\gamma_0 \Gamma_1 \gamma_0)^T S^{bb'T}(x, 0) \Gamma_1^T D^{ac'}(x, 0)(\gamma_0 \Gamma_2 \gamma_0) \\
& \quad \times \text{Tr}[\Gamma_3 U^{ee}(x, x)] \text{Tr}[(\gamma_0 \Gamma_3 \gamma_0) D^{e'e'}(0, 0)] \\
& + \Gamma_2 U^{ce}(x, x) \Gamma_3 U^{ec'}(x, 0)(\gamma_0 \Gamma_2 \gamma_0) \text{Tr}[\Gamma_1 \\
& \quad \times S^{bb'}(x, 0)(\gamma_0 \Gamma_1 \gamma_0) D^{e'a'T}(0, 0)(\gamma_0 \Gamma_3 \gamma_0)^T D^{ae'T}(x, 0)] \\
& - \Gamma_2 U^{cc'}(x, 0)(\gamma_0 \Gamma_2 \gamma_0) \text{Tr}[\Gamma_1 S^{bb'}(x, 0)(\gamma_0 \Gamma_1 \gamma_0) \\
& \quad \times D^{e'a'T}(0, 0)(\gamma_0 \Gamma_3 \gamma_0)^T D^{ae'T}(x, 0)] \text{Tr}[\Gamma_3 U^{ee}(x, x)] \\
& - \Gamma_2 U^{ce}(x, x) \Gamma_3 U^{ec'}(x, 0)(\gamma_0 \Gamma_2 \gamma_0) \text{Tr}[\Gamma_1 \\
& \quad \times S^{bb'}(x, 0)(\gamma_0 \Gamma_1 \gamma_0) D^{aa'T}(x, 0)] \text{Tr}[(\gamma_0 \Gamma_3 \gamma_0) D^{e'e'}(0, 0)] \\
& + \Gamma_2 U^{cc'}(x, 0)(\gamma_0 \Gamma_2 \gamma_0) \text{Tr}[\Gamma_1 S^{bb'}(x, 0)(\gamma_0 \Gamma_1 \gamma_0) \\
& \quad \times D^{aa'T}(x, 0)] \text{Tr}[\Gamma_3 U^{ee}(x, x)] \text{Tr}[(\gamma_0 \Gamma_3 \gamma_0) D^{e'e'}(0, 0)] \\
& + \Gamma_2 U^{ce}(x, x) \Gamma_3 U^{ea'}(x, 0)(\gamma_0 \Gamma_1 \gamma_0)^T D^{ab'T}(x, 0) \Gamma_1 \\
& \quad \times S^{be'}(x, 0)(\gamma_0 \Gamma_3 \gamma_0) S^{e'c'}(0, 0)(\gamma_0 \Gamma_2 \gamma_0) \\
& - \Gamma_2 U^{ca'}(x, 0)(\gamma_0 \Gamma_1 \gamma_0)^T D^{ab'T}(x, 0) \Gamma_1 S^{be'}(x, 0)(\gamma_0 \Gamma_3 \gamma_0) \\
& \quad \times S^{e'c'}(0, 0)(\gamma_0 \Gamma_2 \gamma_0) \text{Tr}[\Gamma_3 U^{ee}(x, x)] \\
& - \Gamma_2 U^{ce}(x, x) \Gamma_3 U^{ea'}(x, 0)(\gamma_0 \Gamma_1 \gamma_0)^T D^{ab'T}(x, 0) \Gamma_1 \\
& \quad \times S^{bc'}(x, 0)(\gamma_0 \Gamma_2 \gamma_0) \text{Tr}[(\gamma_0 \Gamma_3 \gamma_0) S^{e'e'}(0, 0)] \\
& + \Gamma_2 U^{ca'}(x, 0)(\gamma_0 \Gamma_1 \gamma_0)^T D^{ab'T}(x, 0) \Gamma_1 S^{bc'}(x, 0)(\gamma_0 \Gamma_2 \gamma_0) \\
& \quad \times \text{Tr}[\Gamma_3 U^{ee}(x, x)] \text{Tr}[(\gamma_0 \Gamma_3 \gamma_0) S^{e'e'}(0, 0)] \\
& + \Gamma_2 U^{ce}(x, x) \Gamma_3 U^{ea'}(x, 0)(\gamma_0 \Gamma_1 \gamma_0)^T S^{e'b'T}(0, 0)(\gamma_0 \Gamma_3 \gamma_0)^T \\
& \quad \times S^{be'T}(x, 0) \Gamma_1^T D^{ac'}(x, 0)(\gamma_0 \Gamma_2 \gamma_0) \\
& - \Gamma_2 U^{ca'}(x, 0)(\gamma_0 \Gamma_1 \gamma_0)^T S^{e'b'T}(0, 0)(\gamma_0 \Gamma_3 \gamma_0)^T S^{be'T}(x, 0) \Gamma_1^T \\
& \quad \times D^{ac'}(x, 0)(\gamma_0 \Gamma_2 \gamma_0) \text{Tr}[\Gamma_3 U^{ee}(x, x)] \\
& - \Gamma_2 U^{ce}(x, x) \Gamma_3 U^{ea'}(x, 0)(\gamma_0 \Gamma_1 \gamma_0)^T S^{bb'T}(x, 0) \Gamma_1^T \\
& \quad \times D^{ac'}(x, 0)(\gamma_0 \Gamma_2 \gamma_0) \text{Tr}[(\gamma_0 \Gamma_3 \gamma_0) S^{e'e'}(0, 0)] \\
& + \Gamma_2 U^{ca'}(x, 0)(\gamma_0 \Gamma_1 \gamma_0)^T S^{bb'T}(x, 0) \Gamma_1^T D^{ac'}(x, 0)(\gamma_0 \Gamma_2 \gamma_0) \\
& \quad \times \text{Tr}[\Gamma_3 U^{ee}(x, x)] \text{Tr}[(\gamma_0 \Gamma_3 \gamma_0) S^{e'e'}(0, 0)] \\
& + \Gamma_2 U^{ce}(x, x) \Gamma_3 U^{ec'}(x, 0)(\gamma_0 \Gamma_2 \gamma_0) \text{Tr}[\Gamma_1 \\
& \quad \times S^{be'}(x, 0)(\gamma_0 \Gamma_3 \gamma_0) S^{e'b'}(0, 0)(\gamma_0 \Gamma_1 \gamma_0) D^{aa'T}(x, 0)] \\
& - \Gamma_2 U^{cc'}(x, 0)(\gamma_0 \Gamma_2 \gamma_0) \text{Tr}[\Gamma_1 S^{be'}(x, 0)(\gamma_0 \Gamma_3 \gamma_0) \\
& \quad \times S^{e'b'}(0, 0)(\gamma_0 \Gamma_1 \gamma_0) D^{aa'T}(x, 0)] \text{Tr}[\Gamma_3 U^{ee}(x, x)] \\
& - \Gamma_2 U^{ce}(x, x) \Gamma_3 U^{ec'}(x, 0)(\gamma_0 \Gamma_2 \gamma_0) \text{Tr}[\Gamma_1
\end{aligned}$$



$$\begin{aligned}
& \times S^{bb'}(x, 0)(\gamma_0 \Gamma_1 \gamma_0) D^{aa'T}(x, 0) \text{Tr}[(\gamma_0 \Gamma_3 \gamma_0) S^{e'e'}(0, 0)] \\
& + \Gamma_2 U^{cc'}(x, 0)(\gamma_0 \Gamma_2 \gamma_0) \text{Tr}[\Gamma_1 S^{bb'}(x, 0)(\gamma_0 \Gamma_1 \gamma_0) \\
& \quad \times D^{aa'T}(x, 0)] \text{Tr}[\Gamma_3 U^{ee}(x, x)] \text{Tr}[(\gamma_0 \Gamma_3 \gamma_0) S^{e'e'}(0, 0)] \\
& + \Gamma_2 S^{cc'}(x, 0)(\gamma_0 \Gamma_2 \gamma_0) \text{Tr}[\Gamma_1 D^{be}(x, x) \Gamma_3 \\
& \quad \times D^{eb'}(x, 0)(\gamma_0 \Gamma_1 \gamma_0) U^{e'a'T}(0, 0)(\gamma_0 \Gamma_3 \gamma_0)^T U^{ae'T}(x, 0)] \\
& - \Gamma_2 S^{cc'}(x, 0)(\gamma_0 \Gamma_2 \gamma_0) \text{Tr}[\Gamma_1 D^{be}(x, x) \Gamma_3 \\
& \quad \times D^{eb'}(x, 0)(\gamma_0 \Gamma_1 \gamma_0) U^{aa'T}(x, 0)] \text{Tr}[(\gamma_0 \Gamma_3 \gamma_0) U^{e'e'}(0, 0)] \\
& - \Gamma_2 S^{cc'}(x, 0)(\gamma_0 \Gamma_2 \gamma_0) \text{Tr}[\Gamma_1 D^{bb'}(x, 0)(\gamma_0 \Gamma_1 \gamma_0) \\
& \quad \times U^{e'a'T}(0, 0)(\gamma_0 \Gamma_3 \gamma_0)^T U^{ae'T}(x, 0)] \text{Tr}[\Gamma_3 D^{ee}(x, x)] \\
& + \Gamma_2 S^{cc'}(x, 0)(\gamma_0 \Gamma_2 \gamma_0) \text{Tr}[\Gamma_1 D^{bb'}(x, 0)(\gamma_0 \Gamma_1 \gamma_0) \\
& \quad \times U^{aa'T}(x, 0)] \text{Tr}[\Gamma_3 D^{ee}(x, x)] \text{Tr}[(\gamma_0 \Gamma_3 \gamma_0) U^{e'e'}(0, 0)] \\
& + \Gamma_2 S^{cb'}(x, 0)(\gamma_0 \Gamma_1 \gamma_0) U^{e'a'T}(0, 0)(\gamma_0 \Gamma_3 \gamma_0)^T U^{ae'T}(x, 0) \Gamma_1 \\
& \quad \times D^{be}(x, x) \Gamma_3 D^{ec'}(x, 0)(\gamma_0 \Gamma_2 \gamma_0) \\
& - \Gamma_2 S^{cb'}(x, 0)(\gamma_0 \Gamma_1 \gamma_0) U^{aa'T}(x, 0) \Gamma_1 D^{be}(x, x) \Gamma_3 \\
& \quad \times D^{ec'}(x, 0)(\gamma_0 \Gamma_2 \gamma_0) \text{Tr}[(\gamma_0 \Gamma_3 \gamma_0) U^{e'e'}(0, 0)] \\
& - \Gamma_2 S^{cb'}(x, 0)(\gamma_0 \Gamma_1 \gamma_0) U^{e'a'T}(0, 0)(\gamma_0 \Gamma_3 \gamma_0)^T U^{ae'T}(x, 0) \Gamma_1 \\
& \quad \times D^{bc'}(x, 0)(\gamma_0 \Gamma_2 \gamma_0) \text{Tr}[\Gamma_3 D^{ee}(x, x)] \\
& + \Gamma_2 S^{cb'}(x, 0)(\gamma_0 \Gamma_1 \gamma_0) U^{aa'T}(x, 0) \Gamma_1 D^{bc'}(x, 0)(\gamma_0 \Gamma_2 \gamma_0) \\
& \quad \times \text{Tr}[\Gamma_3 D^{ee}(x, x)] \text{Tr}[(\gamma_0 \Gamma_3 \gamma_0) U^{e'e'}(0, 0)] \\
& + \Gamma_2 S^{cb'}(x, 0)(\gamma_0 \Gamma_1 \gamma_0) D^{ea'T}(x, 0) \Gamma_3^T D^{be'T}(x, x) \Gamma_1^T \\
& \quad \times U^{ae'}(x, 0)(\gamma_0 \Gamma_3 \gamma_0) U^{e'c'}(0, 0)(\gamma_0 \Gamma_2 \gamma_0) \\
& - \Gamma_2 S^{cb'}(x, 0)(\gamma_0 \Gamma_1 \gamma_0) D^{ea'T}(x, 0) \Gamma_3^T D^{be'T}(x, x) \Gamma_1^T \\
& \quad \times U^{ac'}(x, 0)(\gamma_0 \Gamma_2 \gamma_0) \text{Tr}[(\gamma_0 \Gamma_3 \gamma_0) U^{e'e'}(0, 0)] \\
& - \Gamma_2 S^{cb'}(x, 0)(\gamma_0 \Gamma_1 \gamma_0) D^{ba'T}(x, 0) \Gamma_1^T U^{ae'}(x, 0)(\gamma_0 \Gamma_3 \gamma_0) \\
& \quad \times U^{e'c'}(0, 0)(\gamma_0 \Gamma_2 \gamma_0) \text{Tr}[\Gamma_3 D^{ee}(x, x)] \\
& + \Gamma_2 S^{cb'}(x, 0)(\gamma_0 \Gamma_1 \gamma_0) D^{ba'T}(x, 0) \Gamma_1^T U^{ac'}(x, 0)(\gamma_0 \Gamma_2 \gamma_0) \\
& \quad \times \text{Tr}[\Gamma_3 D^{ee}(x, x)] \text{Tr}[(\gamma_0 \Gamma_3 \gamma_0) U^{e'e'}(0, 0)] \\
& + \Gamma_2 S^{cc'}(x, 0)(\gamma_0 \Gamma_2 \gamma_0) \text{Tr}[\Gamma_1 D^{be}(x, x) \Gamma_3 \\
& \quad \times D^{ee'}(x, 0)(\gamma_0 \Gamma_3 \gamma_0) D^{e'b'}(0, 0)(\gamma_0 \Gamma_1 \gamma_0) U^{aa'T}(x, 0)] \\
& - \Gamma_2 S^{cc'}(x, 0)(\gamma_0 \Gamma_2 \gamma_0) \text{Tr}[\Gamma_1 D^{be}(x, x) \Gamma_3 \\
& \quad \times D^{eb'}(x, 0)(\gamma_0 \Gamma_1 \gamma_0) U^{aa'T}(x, 0)] \text{Tr}[(\gamma_0 \Gamma_3 \gamma_0) D^{e'e'}(0, 0)]
\end{aligned}$$

$$\begin{aligned}
& -\Gamma_2 S^{cc'}(x, 0)(\gamma_0 \Gamma_2 \gamma_0) \text{Tr}[\Gamma_1 D^{be'}(x, 0)(\gamma_0 \Gamma_3 \gamma_0) \\
& \quad \times D^{e'b'}(0, 0)(\gamma_0 \Gamma_1 \gamma_0) U^{aa'T}(x, 0)] \text{Tr}[\Gamma_3 D^{ee}(x, x)] \\
& +\Gamma_2 S^{cc'}(x, 0)(\gamma_0 \Gamma_2 \gamma_0) \text{Tr}[\Gamma_1 D^{be'}(x, 0)(\gamma_0 \Gamma_3 \gamma_0) \\
& \quad \times D^{e'e}(0, x) \Gamma_3 D^{eb'}(x, 0)(\gamma_0 \Gamma_1 \gamma_0) U^{aa'T}(x, 0)] \\
& +\Gamma_2 S^{cc'}(x, 0)(\gamma_0 \Gamma_2 \gamma_0) \text{Tr}[\Gamma_1 D^{bb'}(x, 0)(\gamma_0 \Gamma_1 \gamma_0) \\
& \quad \times U^{aa'T}(x, 0)] \text{Tr}[\Gamma_3 D^{ee}(x, x)] \text{Tr}[(\gamma_0 \Gamma_3 \gamma_0) D^{e'e'}(0, 0)] \\
& -\Gamma_2 S^{cc'}(x, 0)(\gamma_0 \Gamma_2 \gamma_0) \text{Tr}[\Gamma_1 D^{bb'}(x, 0)(\gamma_0 \Gamma_1 \gamma_0) \\
& \quad \times U^{aa'T}(x, 0)] \text{Tr}[\Gamma_3 D^{ee'}(x, 0)(\gamma_0 \Gamma_3 \gamma_0) D^{e'e}(0, x)] \\
& +\Gamma_2 S^{cb'}(x, 0)(\gamma_0 \Gamma_1 \gamma_0) U^{aa'T}(x, 0) \Gamma_1 D^{be}(x, x) \Gamma_3 \\
& \quad \times D^{e'e}(x, 0)(\gamma_0 \Gamma_3 \gamma_0) D^{e'c'}(0, 0)(\gamma_0 \Gamma_2 \gamma_0) \\
& -\Gamma_2 S^{cb'}(x, 0)(\gamma_0 \Gamma_1 \gamma_0) U^{aa'T}(x, 0) \Gamma_1 D^{be}(x, x) \Gamma_3 \\
& \quad \times D^{ec'}(x, 0)(\gamma_0 \Gamma_2 \gamma_0) \text{Tr}[(\gamma_0 \Gamma_3 \gamma_0) D^{e'e'}(0, 0)] \\
& -\Gamma_2 S^{cb'}(x, 0)(\gamma_0 \Gamma_1 \gamma_0) U^{aa'T}(x, 0) \Gamma_1 D^{be'}(x, 0)(\gamma_0 \Gamma_3 \gamma_0) \\
& \quad \times D^{e'c'}(0, 0)(\gamma_0 \Gamma_2 \gamma_0) \text{Tr}[\Gamma_3 D^{ee}(x, x)] \\
& +\Gamma_2 S^{cb'}(x, 0)(\gamma_0 \Gamma_1 \gamma_0) U^{aa'T}(x, 0) \Gamma_1 D^{be'}(x, 0)(\gamma_0 \Gamma_3 \gamma_0) \\
& \quad \times D^{e'e}(0, x) \Gamma_3 D^{ec'}(x, 0)(\gamma_0 \Gamma_2 \gamma_0) \\
& +\Gamma_2 S^{cb'}(x, 0)(\gamma_0 \Gamma_1 \gamma_0) U^{aa'T}(x, 0) \Gamma_1 D^{bc'}(x, 0)(\gamma_0 \Gamma_2 \gamma_0) \\
& \quad \times \text{Tr}[\Gamma_3 D^{ee}(x, x)] \text{Tr}[(\gamma_0 \Gamma_3 \gamma_0) D^{e'e'}(0, 0)] \\
& -\Gamma_2 S^{cb'}(x, 0)(\gamma_0 \Gamma_1 \gamma_0) U^{aa'T}(x, 0) \Gamma_1 D^{bc'}(x, 0)(\gamma_0 \Gamma_2 \gamma_0) \\
& \quad \times \text{Tr}[\Gamma_3 D^{ee'}(x, 0)(\gamma_0 \Gamma_3 \gamma_0) D^{e'e}(0, x)] \\
& +\Gamma_2 S^{cb'}(x, 0)(\gamma_0 \Gamma_1 \gamma_0) D^{e'a'T}(0, 0)(\gamma_0 \Gamma_3 \gamma_0)^T D^{ee'T}(x, 0) \Gamma_3^T \\
& \quad \times D^{be'T}(x, x) \Gamma_1^T U^{ac'}(x, 0)(\gamma_0 \Gamma_2 \gamma_0) \\
& -\Gamma_2 S^{cb'}(x, 0)(\gamma_0 \Gamma_1 \gamma_0) D^{ea'T}(x, 0) \Gamma_3^T D^{be'T}(x, x) \Gamma_1^T \\
& \quad \times U^{ac'}(x, 0)(\gamma_0 \Gamma_2 \gamma_0) \text{Tr}[(\gamma_0 \Gamma_3 \gamma_0) D^{e'e'}(0, 0)] \\
& -\Gamma_2 S^{cb'}(x, 0)(\gamma_0 \Gamma_1 \gamma_0) D^{e'a'T}(0, 0)(\gamma_0 \Gamma_3 \gamma_0)^T D^{be'T}(x, 0) \Gamma_1^T \\
& \quad \times U^{ac'}(x, 0)(\gamma_0 \Gamma_2 \gamma_0) \text{Tr}[\Gamma_3 D^{ee}(x, x)] \\
& +\Gamma_2 S^{cb'}(x, 0)(\gamma_0 \Gamma_1 \gamma_0) D^{ea'T}(x, 0) \Gamma_3^T D^{e'e'T}(0, x)(\gamma_0 \Gamma_3 \gamma_0)^T \\
& \quad \times D^{be'T}(x, 0) \Gamma_1^T U^{ac'}(x, 0)(\gamma_0 \Gamma_2 \gamma_0) \\
& +\Gamma_2 S^{cb'}(x, 0)(\gamma_0 \Gamma_1 \gamma_0) D^{ba'T}(x, 0) \Gamma_1^T U^{ac'}(x, 0)(\gamma_0 \Gamma_2 \gamma_0) \\
& \quad \times \text{Tr}[\Gamma_3 D^{ee}(x, x)] \text{Tr}[(\gamma_0 \Gamma_3 \gamma_0) D^{e'e'}(0, 0)] \\
& -\Gamma_2 S^{cb'}(x, 0)(\gamma_0 \Gamma_1 \gamma_0) D^{ba'T}(x, 0) \Gamma_1^T U^{ac'}(x, 0)(\gamma_0 \Gamma_2 \gamma_0)
\end{aligned}$$

$$\begin{aligned}
& \times \text{Tr}[\Gamma_3 D^{ee'}(x, 0)(\gamma_0 \Gamma_3 \gamma_0) D^{e'e}(0, x)] \\
& + \Gamma_2 S^{ce'}(x, 0)(\gamma_0 \Gamma_3 \gamma_0) S^{e'c'}(0, 0)(\gamma_0 \Gamma_2 \gamma_0) \text{Tr}[\Gamma_1 \\
& \quad \times D^{be}(x, x) \Gamma_3 D^{eb'}(x, 0)(\gamma_0 \Gamma_1 \gamma_0) U^{aa'T}(x, 0)] \\
& - \Gamma_2 S^{ce'}(x, 0)(\gamma_0 \Gamma_3 \gamma_0) S^{e'c'}(0, 0)(\gamma_0 \Gamma_2 \gamma_0) \text{Tr}[\Gamma_1 \\
& \quad \times D^{bb'}(x, 0)(\gamma_0 \Gamma_1 \gamma_0) U^{aa'T}(x, 0)] \text{Tr}[\Gamma_3 D^{ee}(x, x)] \\
& - \Gamma_2 S^{cc'}(x, 0)(\gamma_0 \Gamma_2 \gamma_0) \text{Tr}[\Gamma_1 D^{be}(x, x) \Gamma_3 \\
& \quad \times D^{eb'}(x, 0)(\gamma_0 \Gamma_1 \gamma_0) U^{aa'T}(x, 0)] \text{Tr}[(\gamma_0 \Gamma_3 \gamma_0) S^{e'e'}(0, 0)] \\
& + \Gamma_2 S^{cc'}(x, 0)(\gamma_0 \Gamma_2 \gamma_0) \text{Tr}[\Gamma_1 D^{bb'}(x, 0)(\gamma_0 \Gamma_1 \gamma_0) \\
& \quad \times U^{aa'T}(x, 0)] \text{Tr}[\Gamma_3 D^{ee}(x, x)] \text{Tr}[(\gamma_0 \Gamma_3 \gamma_0) S^{e'e'}(0, 0)] \\
& + \Gamma_2 S^{ce'}(x, 0)(\gamma_0 \Gamma_3 \gamma_0) S^{e'b'}(0, 0)(\gamma_0 \Gamma_1 \gamma_0) U^{aa'T}(x, 0) \Gamma_1 \\
& \quad \times D^{be}(x, x) \Gamma_3 D^{ec'}(x, 0)(\gamma_0 \Gamma_2 \gamma_0) \\
& - \Gamma_2 S^{ce'}(x, 0)(\gamma_0 \Gamma_3 \gamma_0) S^{e'b'}(0, 0)(\gamma_0 \Gamma_1 \gamma_0) U^{aa'T}(x, 0) \Gamma_1 \\
& \quad \times D^{bc'}(x, 0)(\gamma_0 \Gamma_2 \gamma_0) \text{Tr}[\Gamma_3 D^{ee}(x, x)] \\
& - \Gamma_2 S^{cb'}(x, 0)(\gamma_0 \Gamma_1 \gamma_0) U^{aa'T}(x, 0) \Gamma_1 D^{be}(x, x) \Gamma_3 \\
& \quad \times D^{ec'}(x, 0)(\gamma_0 \Gamma_2 \gamma_0) \text{Tr}[(\gamma_0 \Gamma_3 \gamma_0) S^{e'e'}(0, 0)] \\
& + \Gamma_2 S^{cb'}(x, 0)(\gamma_0 \Gamma_1 \gamma_0) U^{aa'T}(x, 0) \Gamma_1 D^{bc'}(x, 0)(\gamma_0 \Gamma_2 \gamma_0) \\
& \quad \times \text{Tr}[\Gamma_3 D^{ee}(x, x)] \text{Tr}[(\gamma_0 \Gamma_3 \gamma_0) S^{e'e'}(0, 0)] \\
& + \Gamma_2 S^{ce'}(x, 0)(\gamma_0 \Gamma_3 \gamma_0) S^{e'b'}(0, 0)(\gamma_0 \Gamma_1 \gamma_0) D^{ea'T}(x, 0) \Gamma_3^T \\
& \quad \times D^{be^T}(x, x) \Gamma_1^T U^{ac'}(x, 0)(\gamma_0 \Gamma_2 \gamma_0) \\
& - \Gamma_2 S^{ce'}(x, 0)(\gamma_0 \Gamma_3 \gamma_0) S^{e'b'}(0, 0)(\gamma_0 \Gamma_1 \gamma_0) D^{ba^T}(x, 0) \Gamma_1^T \\
& \quad \times U^{ac'}(x, 0)(\gamma_0 \Gamma_2 \gamma_0) \text{Tr}[\Gamma_3 D^{ee}(x, x)] \\
& - \Gamma_2 S^{cb'}(x, 0)(\gamma_0 \Gamma_1 \gamma_0) D^{ea^T}(x, 0) \Gamma_3^T D^{be^T}(x, x) \Gamma_1^T \\
& \quad \times U^{ac'}(x, 0)(\gamma_0 \Gamma_2 \gamma_0) \text{Tr}[(\gamma_0 \Gamma_3 \gamma_0) S^{e'e'}(0, 0)] \\
& + \Gamma_2 S^{cb'}(x, 0)(\gamma_0 \Gamma_1 \gamma_0) D^{ba^T}(x, 0) \Gamma_1^T U^{ac'}(x, 0)(\gamma_0 \Gamma_2 \gamma_0) \\
& \quad \times \text{Tr}[\Gamma_3 D^{ee}(x, x)] \text{Tr}[(\gamma_0 \Gamma_3 \gamma_0) S^{e'e'}(0, 0)] \\
& + \Gamma_2 D^{ce}(x, x) \Gamma_3 D^{eb'}(x, 0)(\gamma_0 \Gamma_1 \gamma_0) U^{e'a^T}(0, 0)(\gamma_0 \Gamma_3 \gamma_0)^T \\
& \quad \times U^{ae^T}(x, 0) \Gamma_1 S^{bc'}(x, 0)(\gamma_0 \Gamma_2 \gamma_0) \\
& - \Gamma_2 D^{ce}(x, x) \Gamma_3 D^{eb'}(x, 0)(\gamma_0 \Gamma_1 \gamma_0) U^{aa^T}(x, 0) \Gamma_1 \\
& \quad \times S^{bc'}(x, 0)(\gamma_0 \Gamma_2 \gamma_0) \text{Tr}[(\gamma_0 \Gamma_3 \gamma_0) U^{e'e'}(0, 0)] \\
& - \Gamma_2 D^{cb'}(x, 0)(\gamma_0 \Gamma_1 \gamma_0) U^{e'a^T}(0, 0)(\gamma_0 \Gamma_3 \gamma_0)^T U^{ae^T}(x, 0) \Gamma_1 \\
& \quad \times S^{bc'}(x, 0)(\gamma_0 \Gamma_2 \gamma_0) \text{Tr}[\Gamma_3 D^{ee}(x, x)]
\end{aligned}$$

$$\begin{aligned}
& + \Gamma_2 D^{cb'}(x, 0)(\gamma_0 \Gamma_1 \gamma_0) U^{aa'T}(x, 0) \Gamma_1 S^{bc'}(x, 0)(\gamma_0 \Gamma_2 \gamma_0) \\
& \quad \times \text{Tr}[\Gamma_3 D^{ee}(x, x)] \text{Tr}[(\gamma_0 \Gamma_3 \gamma_0) U^{e'e'}(0, 0)] \\
& + \Gamma_2 D^{ce}(x, x) \Gamma_3 D^{ec'}(x, 0)(\gamma_0 \Gamma_2 \gamma_0) \text{Tr}[\Gamma_1 \\
& \quad \times S^{bb'}(x, 0)(\gamma_0 \Gamma_1 \gamma_0) U^{e'a'T}(0, 0)(\gamma_0 \Gamma_3 \gamma_0)^T U^{ae'T}(x, 0)] \\
& - \Gamma_2 D^{ce}(x, x) \Gamma_3 D^{ec'}(x, 0)(\gamma_0 \Gamma_2 \gamma_0) \text{Tr}[\Gamma_1 \\
& \quad \times S^{bb'}(x, 0)(\gamma_0 \Gamma_1 \gamma_0) U^{aa'T}(x, 0)] \text{Tr}[(\gamma_0 \Gamma_3 \gamma_0) U^{e'e'}(0, 0)] \\
& - \Gamma_2 D^{cc'}(x, 0)(\gamma_0 \Gamma_2 \gamma_0) \text{Tr}[\Gamma_1 S^{bb'}(x, 0)(\gamma_0 \Gamma_1 \gamma_0) \\
& \quad \times U^{e'a'T}(0, 0)(\gamma_0 \Gamma_3 \gamma_0)^T U^{ae'T}(x, 0)] \text{Tr}[\Gamma_3 D^{ee}(x, x)] \\
& + \Gamma_2 D^{cc'}(x, 0)(\gamma_0 \Gamma_2 \gamma_0) \text{Tr}[\Gamma_1 S^{bb'}(x, 0)(\gamma_0 \Gamma_1 \gamma_0) \\
& \quad \times U^{aa'T}(x, 0)] \text{Tr}[\Gamma_3 D^{ee}(x, x)] \text{Tr}[(\gamma_0 \Gamma_3 \gamma_0) U^{e'e'}(0, 0)] \\
& + \Gamma_2 D^{ce}(x, x) \Gamma_3 D^{ea'}(x, 0)(\gamma_0 \Gamma_1 \gamma_0)^T S^{bb'T}(x, 0) \Gamma_1^T \\
& \quad \times U^{ae'}(x, 0)(\gamma_0 \Gamma_3 \gamma_0) U^{e'c'}(0, 0)(\gamma_0 \Gamma_2 \gamma_0) \\
& - \Gamma_2 D^{ce}(x, x) \Gamma_3 D^{ea'}(x, 0)(\gamma_0 \Gamma_1 \gamma_0)^T S^{bb'T}(x, 0) \Gamma_1^T \\
& \quad \times U^{ac'}(x, 0)(\gamma_0 \Gamma_2 \gamma_0) \text{Tr}[(\gamma_0 \Gamma_3 \gamma_0) U^{e'e'}(0, 0)] \\
& - \Gamma_2 D^{ca'}(x, 0)(\gamma_0 \Gamma_1 \gamma_0)^T S^{bb'T}(x, 0) \Gamma_1^T U^{ae'}(x, 0)(\gamma_0 \Gamma_3 \gamma_0) \\
& \quad \times U^{e'c'}(0, 0)(\gamma_0 \Gamma_2 \gamma_0) \text{Tr}[\Gamma_3 D^{ee}(x, x)] \\
& + \Gamma_2 D^{ca'}(x, 0)(\gamma_0 \Gamma_1 \gamma_0)^T S^{bb'T}(x, 0) \Gamma_1^T U^{ac'}(x, 0)(\gamma_0 \Gamma_2 \gamma_0) \\
& \quad \times \text{Tr}[\Gamma_3 D^{ee}(x, x)] \text{Tr}[(\gamma_0 \Gamma_3 \gamma_0) U^{e'e'}(0, 0)] \\
& + \Gamma_2 D^{ce}(x, x) \Gamma_3 D^{ee'}(x, 0)(\gamma_0 \Gamma_3 \gamma_0) D^{e'b'}(0, 0)(\gamma_0 \Gamma_1 \gamma_0) \\
& \quad \times U^{aa'T}(x, 0) \Gamma_1 S^{bc'}(x, 0)(\gamma_0 \Gamma_2 \gamma_0) \\
& - \Gamma_2 D^{ce}(x, x) \Gamma_3 D^{eb'}(x, 0)(\gamma_0 \Gamma_1 \gamma_0) U^{aa'T}(x, 0) \Gamma_1 \\
& \quad \times S^{bc'}(x, 0)(\gamma_0 \Gamma_2 \gamma_0) \text{Tr}[(\gamma_0 \Gamma_3 \gamma_0) D^{e'e'}(0, 0)] \\
& - \Gamma_2 D^{ce'}(x, 0)(\gamma_0 \Gamma_3 \gamma_0) D^{e'b'}(0, 0)(\gamma_0 \Gamma_1 \gamma_0) U^{aa'T}(x, 0) \Gamma_1 \\
& \quad \times S^{bc'}(x, 0)(\gamma_0 \Gamma_2 \gamma_0) \text{Tr}[\Gamma_3 D^{ee}(x, x)] \\
& + \Gamma_2 D^{ce'}(x, 0)(\gamma_0 \Gamma_3 \gamma_0) D^{e'e}(0, x) \Gamma_3 D^{eb'}(x, 0)(\gamma_0 \Gamma_1 \gamma_0) \\
& \quad \times U^{aa'T}(x, 0) \Gamma_1 S^{bc'}(x, 0)(\gamma_0 \Gamma_2 \gamma_0) \\
& + \Gamma_2 D^{cb'}(x, 0)(\gamma_0 \Gamma_1 \gamma_0) U^{aa'T}(x, 0) \Gamma_1 S^{bc'}(x, 0)(\gamma_0 \Gamma_2 \gamma_0) \\
& \quad \times \text{Tr}[\Gamma_3 D^{ee}(x, x)] \text{Tr}[(\gamma_0 \Gamma_3 \gamma_0) D^{e'e'}(0, 0)] \\
& - \Gamma_2 D^{cb'}(x, 0)(\gamma_0 \Gamma_1 \gamma_0) U^{aa'T}(x, 0) \Gamma_1 S^{bc'}(x, 0)(\gamma_0 \Gamma_2 \gamma_0) \\
& \quad \times \text{Tr}[\Gamma_3 D^{ee'}(x, 0)(\gamma_0 \Gamma_3 \gamma_0) D^{e'e}(0, x)] \\
& + \Gamma_2 D^{ce}(x, x) \Gamma_3 D^{ee'}(x, 0)(\gamma_0 \Gamma_3 \gamma_0) D^{e'c'}(0, 0)(\gamma_0 \Gamma_2 \gamma_0)
\end{aligned}$$

$$\begin{aligned}
& \times \text{Tr}[\Gamma_1 S^{bb'}(x, 0)(\gamma_0 \Gamma_1 \gamma_0) U^{aa'T}(x, 0)] \\
& - \Gamma_2 D^{ce}(x, x) \Gamma_3 D^{ec'}(x, 0)(\gamma_0 \Gamma_2 \gamma_0) \text{Tr}[\Gamma_1 \\
& \quad \times S^{bb'}(x, 0)(\gamma_0 \Gamma_1 \gamma_0) U^{aa'T}(x, 0)] \text{Tr}[(\gamma_0 \Gamma_3 \gamma_0) D^{e'e'}(0, 0)] \\
& - \Gamma_2 D^{ce'}(x, 0)(\gamma_0 \Gamma_3 \gamma_0) D^{e'e'}(0, 0)(\gamma_0 \Gamma_2 \gamma_0) \text{Tr}[\Gamma_1 \\
& \quad \times S^{bb'}(x, 0)(\gamma_0 \Gamma_1 \gamma_0) U^{aa'T}(x, 0)] \text{Tr}[\Gamma_3 D^{ee}(x, x)] \\
& + \Gamma_2 D^{ce'}(x, 0)(\gamma_0 \Gamma_3 \gamma_0) D^{e'e'}(0, x) \Gamma_3 D^{ec'}(x, 0)(\gamma_0 \Gamma_2 \gamma_0) \\
& \quad \times \text{Tr}[\Gamma_1 S^{bb'}(x, 0)(\gamma_0 \Gamma_1 \gamma_0) U^{aa'T}(x, 0)] \\
& + \Gamma_2 D^{cc'}(x, 0)(\gamma_0 \Gamma_2 \gamma_0) \text{Tr}[\Gamma_1 S^{bb'}(x, 0)(\gamma_0 \Gamma_1 \gamma_0) \\
& \quad \times U^{aa'T}(x, 0)] \text{Tr}[\Gamma_3 D^{ee}(x, x)] \text{Tr}[(\gamma_0 \Gamma_3 \gamma_0) D^{e'e'}(0, 0)] \\
& - \Gamma_2 D^{cc'}(x, 0)(\gamma_0 \Gamma_2 \gamma_0) \text{Tr}[\Gamma_1 S^{bb'}(x, 0)(\gamma_0 \Gamma_1 \gamma_0) \\
& \quad \times U^{aa'T}(x, 0)] \text{Tr}[\Gamma_3 D^{ee'}(x, 0)(\gamma_0 \Gamma_3 \gamma_0) D^{e'e'}(0, x)] \\
& + \Gamma_2 D^{ce}(x, x) \Gamma_3 D^{ee'}(x, 0)(\gamma_0 \Gamma_3 \gamma_0) D^{e'a'}(0, 0)(\gamma_0 \Gamma_1 \gamma_0)^T \\
& \quad \times S^{bb'T}(x, 0) \Gamma_1^T U^{ac'}(x, 0)(\gamma_0 \Gamma_2 \gamma_0) \\
& - \Gamma_2 D^{ce}(x, x) \Gamma_3 D^{ea'}(x, 0)(\gamma_0 \Gamma_1 \gamma_0)^T S^{bb'T}(x, 0) \Gamma_1^T \\
& \quad \times U^{ac'}(x, 0)(\gamma_0 \Gamma_2 \gamma_0) \text{Tr}[(\gamma_0 \Gamma_3 \gamma_0) D^{e'e'}(0, 0)] \\
& - \Gamma_2 D^{ce'}(x, 0)(\gamma_0 \Gamma_3 \gamma_0) D^{e'a'}(0, 0)(\gamma_0 \Gamma_1 \gamma_0)^T S^{bb'T}(x, 0) \Gamma_1^T \\
& \quad \times U^{ac'}(x, 0)(\gamma_0 \Gamma_2 \gamma_0) \text{Tr}[\Gamma_3 D^{ee}(x, x)] \\
& + \Gamma_2 D^{ce'}(x, 0)(\gamma_0 \Gamma_3 \gamma_0) D^{e'e'}(0, x) \Gamma_3 D^{ea'}(x, 0)(\gamma_0 \Gamma_1 \gamma_0)^T \\
& \quad \times S^{bb'T}(x, 0) \Gamma_1^T U^{ac'}(x, 0)(\gamma_0 \Gamma_2 \gamma_0) \\
& + \Gamma_2 D^{ca'}(x, 0)(\gamma_0 \Gamma_1 \gamma_0)^T S^{bb'T}(x, 0) \Gamma_1^T U^{ac'}(x, 0)(\gamma_0 \Gamma_2 \gamma_0) \\
& \quad \times \text{Tr}[\Gamma_3 D^{ee}(x, x)] \text{Tr}[(\gamma_0 \Gamma_3 \gamma_0) D^{e'e'}(0, 0)] \\
& - \Gamma_2 D^{ca'}(x, 0)(\gamma_0 \Gamma_1 \gamma_0)^T S^{bb'T}(x, 0) \Gamma_1^T U^{ac'}(x, 0)(\gamma_0 \Gamma_2 \gamma_0) \\
& \quad \times \text{Tr}[\Gamma_3 D^{ee'}(x, 0)(\gamma_0 \Gamma_3 \gamma_0) D^{e'e'}(0, x)] \\
& + \Gamma_2 D^{ce}(x, x) \Gamma_3 D^{eb'}(x, 0)(\gamma_0 \Gamma_1 \gamma_0) U^{aa'T}(x, 0) \Gamma_1 \\
& \quad \times S^{be'}(x, 0)(\gamma_0 \Gamma_3 \gamma_0) S^{e'e'}(0, 0)(\gamma_0 \Gamma_2 \gamma_0) \\
& - \Gamma_2 D^{cb'}(x, 0)(\gamma_0 \Gamma_1 \gamma_0) U^{aa'T}(x, 0) \Gamma_1 S^{be'}(x, 0)(\gamma_0 \Gamma_3 \gamma_0) \\
& \quad \times S^{e'e'}(0, 0)(\gamma_0 \Gamma_2 \gamma_0) \text{Tr}[\Gamma_3 D^{ee}(x, x)] \\
& - \Gamma_2 D^{ce}(x, x) \Gamma_3 D^{eb'}(x, 0)(\gamma_0 \Gamma_1 \gamma_0) U^{aa'T}(x, 0) \Gamma_1 \\
& \quad \times S^{bc'}(x, 0)(\gamma_0 \Gamma_2 \gamma_0) \text{Tr}[(\gamma_0 \Gamma_3 \gamma_0) S^{e'e'}(0, 0)] \\
& + \Gamma_2 D^{cb'}(x, 0)(\gamma_0 \Gamma_1 \gamma_0) U^{aa'T}(x, 0) \Gamma_1 S^{bc'}(x, 0)(\gamma_0 \Gamma_2 \gamma_0) \\
& \quad \times \text{Tr}[\Gamma_3 D^{ee}(x, x)] \text{Tr}[(\gamma_0 \Gamma_3 \gamma_0) S^{e'e'}(0, 0)]
\end{aligned}$$

$$\begin{aligned}
& + \Gamma_2 D^{ce}(x, x) \Gamma_3 D^{ec'}(x, 0) (\gamma_0 \Gamma_2 \gamma_0) \text{Tr} [\Gamma_1 \\
& \quad \times S^{be'}(x, 0) (\gamma_0 \Gamma_3 \gamma_0) S^{e'b'}(0, 0) (\gamma_0 \Gamma_1 \gamma_0) U^{aa'T}(x, 0)] \\
& - \Gamma_2 D^{cc'}(x, 0) (\gamma_0 \Gamma_2 \gamma_0) \text{Tr} [\Gamma_1 S^{be'}(x, 0) (\gamma_0 \Gamma_3 \gamma_0) \\
& \quad \times S^{e'b'}(0, 0) (\gamma_0 \Gamma_1 \gamma_0) U^{aa'T}(x, 0)] \text{Tr} [\Gamma_3 D^{ee}(x, x)] \\
& - \Gamma_2 D^{ce}(x, x) \Gamma_3 D^{ec'}(x, 0) (\gamma_0 \Gamma_2 \gamma_0) \text{Tr} [\Gamma_1 \\
& \quad \times S^{bb'}(x, 0) (\gamma_0 \Gamma_1 \gamma_0) U^{aa'T}(x, 0)] \text{Tr} [(\gamma_0 \Gamma_3 \gamma_0) S^{e'e'}(0, 0)] \\
& + \Gamma_2 D^{cc'}(x, 0) (\gamma_0 \Gamma_2 \gamma_0) \text{Tr} [\Gamma_1 S^{bb'}(x, 0) (\gamma_0 \Gamma_1 \gamma_0) \\
& \quad \times U^{aa'T}(x, 0)] \text{Tr} [\Gamma_3 D^{ee}(x, x)] \text{Tr} [(\gamma_0 \Gamma_3 \gamma_0) S^{e'e'}(0, 0)] \\
& + \Gamma_2 D^{ce}(x, x) \Gamma_3 D^{ea'}(x, 0) (\gamma_0 \Gamma_1 \gamma_0)^T S^{e'b'T}(0, 0) (\gamma_0 \Gamma_3 \gamma_0)^T \\
& \quad \times S^{be'T}(x, 0) \Gamma_1^T U^{ac'}(x, 0) (\gamma_0 \Gamma_2 \gamma_0) \\
& - \Gamma_2 D^{ca'}(x, 0) (\gamma_0 \Gamma_1 \gamma_0)^T S^{e'b'T}(0, 0) (\gamma_0 \Gamma_3 \gamma_0)^T S^{be'T}(x, 0) \Gamma_1^T \\
& \quad \times U^{ac'}(x, 0) (\gamma_0 \Gamma_2 \gamma_0) \text{Tr} [\Gamma_3 D^{ee}(x, x)] \\
& - \Gamma_2 D^{ce}(x, x) \Gamma_3 D^{ea'}(x, 0) (\gamma_0 \Gamma_1 \gamma_0)^T S^{bb'T}(x, 0) \Gamma_1^T \\
& \quad \times U^{ac'}(x, 0) (\gamma_0 \Gamma_2 \gamma_0) \text{Tr} [(\gamma_0 \Gamma_3 \gamma_0) S^{e'e'}(0, 0)] \\
& + \Gamma_2 D^{ca'}(x, 0) (\gamma_0 \Gamma_1 \gamma_0)^T S^{bb'T}(x, 0) \Gamma_1^T U^{ac'}(x, 0) (\gamma_0 \Gamma_2 \gamma_0) \\
& \quad \times \text{Tr} [\Gamma_3 D^{ee}(x, x)] \text{Tr} [(\gamma_0 \Gamma_3 \gamma_0) S^{e'e'}(0, 0)] \\
& + \Gamma_2 U^{ce'}(x, 0) (\gamma_0 \Gamma_3 \gamma_0) U^{e'a'}(0, 0) (\gamma_0 \Gamma_1 \gamma_0)^T D^{eb'T}(x, 0) \Gamma_3^T \\
& \quad \times D^{ae'T}(x, x) \Gamma_1 S^{bc'}(x, 0) (\gamma_0 \Gamma_2 \gamma_0) \\
& - \Gamma_2 U^{ca'}(x, 0) (\gamma_0 \Gamma_1 \gamma_0)^T D^{eb'T}(x, 0) \Gamma_3^T D^{ae'T}(x, x) \Gamma_1 \\
& \quad \times S^{bc'}(x, 0) (\gamma_0 \Gamma_2 \gamma_0) \text{Tr} [(\gamma_0 \Gamma_3 \gamma_0) U^{e'e'}(0, 0)] \\
& - \Gamma_2 U^{ce'}(x, 0) (\gamma_0 \Gamma_3 \gamma_0) U^{e'a'}(0, 0) (\gamma_0 \Gamma_1 \gamma_0)^T D^{ab'T}(x, 0) \Gamma_1 \\
& \quad \times S^{bc'}(x, 0) (\gamma_0 \Gamma_2 \gamma_0) \text{Tr} [\Gamma_3 D^{ee}(x, x)] \\
& + \Gamma_2 U^{ca'}(x, 0) (\gamma_0 \Gamma_1 \gamma_0)^T D^{ab'T}(x, 0) \Gamma_1 S^{bc'}(x, 0) (\gamma_0 \Gamma_2 \gamma_0) \\
& \quad \times \text{Tr} [\Gamma_3 D^{ee}(x, x)] \text{Tr} [(\gamma_0 \Gamma_3 \gamma_0) U^{e'e'}(0, 0)] \\
& + \Gamma_2 U^{ce'}(x, 0) (\gamma_0 \Gamma_3 \gamma_0) U^{e'a'}(0, 0) (\gamma_0 \Gamma_1 \gamma_0)^T S^{bb'T}(x, 0) \Gamma_1^T \\
& \quad \times D^{ae}(x, x) \Gamma_3 D^{ec'}(x, 0) (\gamma_0 \Gamma_2 \gamma_0) \\
& - \Gamma_2 U^{ca'}(x, 0) (\gamma_0 \Gamma_1 \gamma_0)^T S^{bb'T}(x, 0) \Gamma_1^T D^{ae}(x, x) \Gamma_3 \\
& \quad \times D^{ec'}(x, 0) (\gamma_0 \Gamma_2 \gamma_0) \text{Tr} [(\gamma_0 \Gamma_3 \gamma_0) U^{e'e'}(0, 0)] \\
& - \Gamma_2 U^{ce'}(x, 0) (\gamma_0 \Gamma_3 \gamma_0) U^{e'a'}(0, 0) (\gamma_0 \Gamma_1 \gamma_0)^T S^{bb'T}(x, 0) \Gamma_1^T \\
& \quad \times D^{ac'}(x, 0) (\gamma_0 \Gamma_2 \gamma_0) \text{Tr} [\Gamma_3 D^{ee}(x, x)] \\
& + \Gamma_2 U^{ca'}(x, 0) (\gamma_0 \Gamma_1 \gamma_0)^T S^{bb'T}(x, 0) \Gamma_1^T D^{ac'}(x, 0) (\gamma_0 \Gamma_2 \gamma_0)
\end{aligned}$$

$$\begin{aligned}
& \times \text{Tr}[\Gamma_3 D^{ee}(x, x)] \text{Tr}[(\gamma_0 \Gamma_3 \gamma_0) U^{e'e'}(0, 0)] \\
& + \Gamma_2 U^{ce'}(x, 0) (\gamma_0 \Gamma_3 \gamma_0) U^{e'c'}(0, 0) (\gamma_0 \Gamma_2 \gamma_0) \text{Tr}[\Gamma_1 \\
& \quad \times S^{bb'}(x, 0) (\gamma_0 \Gamma_1 \gamma_0) D^{ea'T}(x, 0) \Gamma_3^T D^{ae'T}(x, x)] \\
& - \Gamma_2 U^{cc'}(x, 0) (\gamma_0 \Gamma_2 \gamma_0) \text{Tr}[\Gamma_1 S^{bb'}(x, 0) (\gamma_0 \Gamma_1 \gamma_0) \\
& \quad \times D^{ea'T}(x, 0) \Gamma_3^T D^{ae'T}(x, x)] \text{Tr}[(\gamma_0 \Gamma_3 \gamma_0) U^{e'e'}(0, 0)] \\
& - \Gamma_2 U^{ce'}(x, 0) (\gamma_0 \Gamma_3 \gamma_0) U^{e'c'}(0, 0) (\gamma_0 \Gamma_2 \gamma_0) \text{Tr}[\Gamma_1 \\
& \quad \times S^{bb'}(x, 0) (\gamma_0 \Gamma_1 \gamma_0) D^{aa'T}(x, 0)] \text{Tr}[\Gamma_3 D^{ee}(x, x)] \\
& + \Gamma_2 U^{cc'}(x, 0) (\gamma_0 \Gamma_2 \gamma_0) \text{Tr}[\Gamma_1 S^{bb'}(x, 0) (\gamma_0 \Gamma_1 \gamma_0) \\
& \quad \times D^{aa'T}(x, 0)] \text{Tr}[\Gamma_3 D^{ee}(x, x)] \text{Tr}[(\gamma_0 \Gamma_3 \gamma_0) U^{e'e'}(0, 0)] \\
& + \Gamma_2 U^{ca'}(x, 0) (\gamma_0 \Gamma_1 \gamma_0)^T D^{e'b'T}(0, 0) (\gamma_0 \Gamma_3 \gamma_0)^T D^{ee'T}(x, 0) \Gamma_3^T \\
& \quad \times D^{ae'T}(x, x) \Gamma_1 S^{bc'}(x, 0) (\gamma_0 \Gamma_2 \gamma_0) \\
& - \Gamma_2 U^{ca'}(x, 0) (\gamma_0 \Gamma_1 \gamma_0)^T D^{eb'T}(x, 0) \Gamma_3^T D^{ae'T}(x, x) \Gamma_1 \\
& \quad \times S^{bc'}(x, 0) (\gamma_0 \Gamma_2 \gamma_0) \text{Tr}[(\gamma_0 \Gamma_3 \gamma_0) D^{e'e'}(0, 0)] \\
& - \Gamma_2 U^{ca'}(x, 0) (\gamma_0 \Gamma_1 \gamma_0)^T D^{e'b'T}(0, 0) (\gamma_0 \Gamma_3 \gamma_0)^T D^{ae'T}(x, 0) \Gamma_1 \\
& \quad \times S^{bc'}(x, 0) (\gamma_0 \Gamma_2 \gamma_0) \text{Tr}[\Gamma_3 D^{ee}(x, x)] \\
& + \Gamma_2 U^{ca'}(x, 0) (\gamma_0 \Gamma_1 \gamma_0)^T D^{eb'T}(x, 0) \Gamma_3^T D^{e'e'T}(0, x) (\gamma_0 \Gamma_3 \gamma_0)^T \\
& \quad \times D^{ae'T}(x, 0) \Gamma_1 S^{bc'}(x, 0) (\gamma_0 \Gamma_2 \gamma_0) \\
& + \Gamma_2 U^{ca'}(x, 0) (\gamma_0 \Gamma_1 \gamma_0)^T D^{ab'T}(x, 0) \Gamma_1 S^{bc'}(x, 0) (\gamma_0 \Gamma_2 \gamma_0) \\
& \quad \times \text{Tr}[\Gamma_3 D^{ee}(x, x)] \text{Tr}[(\gamma_0 \Gamma_3 \gamma_0) D^{e'e'}(0, 0)] \\
& - \Gamma_2 U^{ca'}(x, 0) (\gamma_0 \Gamma_1 \gamma_0)^T D^{ab'T}(x, 0) \Gamma_1 S^{bc'}(x, 0) (\gamma_0 \Gamma_2 \gamma_0) \\
& \quad \times \text{Tr}[\Gamma_3 D^{ee'}(x, 0) (\gamma_0 \Gamma_3 \gamma_0) D^{e'e}(0, x)] \\
& + \Gamma_2 U^{ca'}(x, 0) (\gamma_0 \Gamma_1 \gamma_0)^T S^{bb'T}(x, 0) \Gamma_1^T D^{ae}(x, x) \Gamma_3 \\
& \quad \times D^{ee'}(x, 0) (\gamma_0 \Gamma_3 \gamma_0) D^{e'c'}(0, 0) (\gamma_0 \Gamma_2 \gamma_0) \\
& - \Gamma_2 U^{ca'}(x, 0) (\gamma_0 \Gamma_1 \gamma_0)^T S^{bb'T}(x, 0) \Gamma_1^T D^{ae}(x, x) \Gamma_3 \\
& \quad \times D^{ec'}(x, 0) (\gamma_0 \Gamma_2 \gamma_0) \text{Tr}[(\gamma_0 \Gamma_3 \gamma_0) D^{e'e'}(0, 0)] \\
& - \Gamma_2 U^{ca'}(x, 0) (\gamma_0 \Gamma_1 \gamma_0)^T S^{bb'T}(x, 0) \Gamma_1^T D^{ae'}(x, 0) (\gamma_0 \Gamma_3 \gamma_0) \\
& \quad \times D^{e'c'}(0, 0) (\gamma_0 \Gamma_2 \gamma_0) \text{Tr}[\Gamma_3 D^{ee}(x, x)] \\
& + \Gamma_2 U^{ca'}(x, 0) (\gamma_0 \Gamma_1 \gamma_0)^T S^{bb'T}(x, 0) \Gamma_1^T D^{ae'}(x, 0) (\gamma_0 \Gamma_3 \gamma_0) \\
& \quad \times D^{e'e}(0, x) \Gamma_3 D^{ec'}(x, 0) (\gamma_0 \Gamma_2 \gamma_0) \\
& + \Gamma_2 U^{ca'}(x, 0) (\gamma_0 \Gamma_1 \gamma_0)^T S^{bb'T}(x, 0) \Gamma_1^T D^{ac'}(x, 0) (\gamma_0 \Gamma_2 \gamma_0) \\
& \quad \times \text{Tr}[\Gamma_3 D^{ee}(x, x)] \text{Tr}[(\gamma_0 \Gamma_3 \gamma_0) D^{e'e'}(0, 0)]
\end{aligned}$$

$$\begin{aligned}
& -\Gamma_2 U^{ca'}(x, 0)(\gamma_0 \Gamma_1 \gamma_0)^T S^{bb'T}(x, 0) \Gamma_1^T D^{ac'}(x, 0)(\gamma_0 \Gamma_2 \gamma_0) \\
& \quad \times \text{Tr}[\Gamma_3 D^{ee'}(x, 0)(\gamma_0 \Gamma_3 \gamma_0) D^{e'e}(0, x)] \\
& + \Gamma_2 U^{cc'}(x, 0)(\gamma_0 \Gamma_2 \gamma_0) \text{Tr}[\Gamma_1 S^{bb'}(x, 0)(\gamma_0 \Gamma_1 \gamma_0) \\
& \quad \times D^{e'a'T}(0, 0)(\gamma_0 \Gamma_3 \gamma_0)^T D^{ee'T}(x, 0) \Gamma_3^T D^{ae'T}(x, x)] \\
& - \Gamma_2 U^{cc'}(x, 0)(\gamma_0 \Gamma_2 \gamma_0) \text{Tr}[\Gamma_1 S^{bb'}(x, 0)(\gamma_0 \Gamma_1 \gamma_0) \\
& \quad \times D^{ea'T}(x, 0) \Gamma_3^T D^{ae'T}(x, x)] \text{Tr}[(\gamma_0 \Gamma_3 \gamma_0) D^{e'e'}(0, 0)] \\
& - \Gamma_2 U^{cc'}(x, 0)(\gamma_0 \Gamma_2 \gamma_0) \text{Tr}[\Gamma_1 S^{bb'}(x, 0)(\gamma_0 \Gamma_1 \gamma_0) \\
& \quad \times D^{e'a'T}(0, 0)(\gamma_0 \Gamma_3 \gamma_0)^T D^{ae'T}(x, 0)] \text{Tr}[\Gamma_3 D^{ee}(x, x)] \\
& + \Gamma_2 U^{cc'}(x, 0)(\gamma_0 \Gamma_2 \gamma_0) \text{Tr}[\Gamma_1 S^{bb'}(x, 0)(\gamma_0 \Gamma_1 \gamma_0) \\
& \quad \times D^{ea'T}(x, 0) \Gamma_3^T D^{e'e'T}(0, x)(\gamma_0 \Gamma_3 \gamma_0)^T D^{ae'T}(x, 0)] \\
& + \Gamma_2 U^{cc'}(x, 0)(\gamma_0 \Gamma_2 \gamma_0) \text{Tr}[\Gamma_1 S^{bb'}(x, 0)(\gamma_0 \Gamma_1 \gamma_0) \\
& \quad \times D^{aa'T}(x, 0)] \text{Tr}[\Gamma_3 D^{ee}(x, x)] \text{Tr}[(\gamma_0 \Gamma_3 \gamma_0) D^{e'e'}(0, 0)] \\
& - \Gamma_2 U^{cc'}(x, 0)(\gamma_0 \Gamma_2 \gamma_0) \text{Tr}[\Gamma_1 S^{bb'}(x, 0)(\gamma_0 \Gamma_1 \gamma_0) \\
& \quad \times D^{aa'T}(x, 0)] \text{Tr}[\Gamma_3 D^{ee'}(x, 0)(\gamma_0 \Gamma_3 \gamma_0) D^{e'e}(0, x)] \\
& + \Gamma_2 U^{ca'}(x, 0)(\gamma_0 \Gamma_1 \gamma_0)^T D^{eb'T}(x, 0) \Gamma_3^T D^{ae'T}(x, x) \Gamma_1 \\
& \quad \times S^{be'}(x, 0)(\gamma_0 \Gamma_3 \gamma_0) S^{e'c'}(0, 0)(\gamma_0 \Gamma_2 \gamma_0) \\
& - \Gamma_2 U^{ca'}(x, 0)(\gamma_0 \Gamma_1 \gamma_0)^T D^{ab'T}(x, 0) \Gamma_1 S^{be'}(x, 0)(\gamma_0 \Gamma_3 \gamma_0) \\
& \quad \times S^{e'c'}(0, 0)(\gamma_0 \Gamma_2 \gamma_0) \text{Tr}[\Gamma_3 D^{ee}(x, x)] \\
& - \Gamma_2 U^{ca'}(x, 0)(\gamma_0 \Gamma_1 \gamma_0)^T D^{eb'T}(x, 0) \Gamma_3^T D^{ae'T}(x, x) \Gamma_1 \\
& \quad \times S^{bc'}(x, 0)(\gamma_0 \Gamma_2 \gamma_0) \text{Tr}[(\gamma_0 \Gamma_3 \gamma_0) S^{e'e'}(0, 0)] \\
& + \Gamma_2 U^{ca'}(x, 0)(\gamma_0 \Gamma_1 \gamma_0)^T D^{ab'T}(x, 0) \Gamma_1 S^{bc'}(x, 0)(\gamma_0 \Gamma_2 \gamma_0) \\
& \quad \times \text{Tr}[\Gamma_3 D^{ee}(x, x)] \text{Tr}[(\gamma_0 \Gamma_3 \gamma_0) S^{e'e'}(0, 0)] \\
& + \Gamma_2 U^{ca'}(x, 0)(\gamma_0 \Gamma_1 \gamma_0)^T S^{e'b'T}(0, 0)(\gamma_0 \Gamma_3 \gamma_0)^T S^{be'T}(x, 0) \Gamma_1^T \\
& \quad \times D^{ae}(x, x) \Gamma_3 D^{ec'}(x, 0)(\gamma_0 \Gamma_2 \gamma_0) \\
& - \Gamma_2 U^{ca'}(x, 0)(\gamma_0 \Gamma_1 \gamma_0)^T S^{e'b'T}(0, 0)(\gamma_0 \Gamma_3 \gamma_0)^T S^{be'T}(x, 0) \Gamma_1^T \\
& \quad \times D^{ac'}(x, 0)(\gamma_0 \Gamma_2 \gamma_0) \text{Tr}[\Gamma_3 D^{ee}(x, x)] \\
& - \Gamma_2 U^{ca'}(x, 0)(\gamma_0 \Gamma_1 \gamma_0)^T S^{bb'T}(x, 0) \Gamma_1^T D^{ae}(x, x) \Gamma_3 \\
& \quad \times D^{ec'}(x, 0)(\gamma_0 \Gamma_2 \gamma_0) \text{Tr}[(\gamma_0 \Gamma_3 \gamma_0) S^{e'e'}(0, 0)] \\
& + \Gamma_2 U^{ca'}(x, 0)(\gamma_0 \Gamma_1 \gamma_0)^T S^{bb'T}(x, 0) \Gamma_1^T D^{ac'}(x, 0)(\gamma_0 \Gamma_2 \gamma_0) \\
& \quad \times \text{Tr}[\Gamma_3 D^{ee}(x, x)] \text{Tr}[(\gamma_0 \Gamma_3 \gamma_0) S^{e'e'}(0, 0)] \\
& + \Gamma_2 U^{cc'}(x, 0)(\gamma_0 \Gamma_2 \gamma_0) \text{Tr}[\Gamma_1 S^{be'}(x, 0)(\gamma_0 \Gamma_3 \gamma_0)
\end{aligned}$$



$$\begin{aligned}
& \times S^{e'b'}(0,0)(\gamma_0\Gamma_1\gamma_0)D^{ea'T}(x,0)\Gamma_3^T D^{ae'T}(x,x)] \\
& - \Gamma_2 U^{cc'}(x,0)(\gamma_0\Gamma_2\gamma_0)\text{Tr}[\Gamma_1 S^{be'}(x,0)(\gamma_0\Gamma_3\gamma_0) \\
& \quad \times S^{e'b'}(0,0)(\gamma_0\Gamma_1\gamma_0)D^{aa'T}(x,0)]\text{Tr}[\Gamma_3 D^{ee}(x,x)] \\
& - \Gamma_2 U^{cc'}(x,0)(\gamma_0\Gamma_2\gamma_0)\text{Tr}[\Gamma_1 S^{bb'}(x,0)(\gamma_0\Gamma_1\gamma_0) \\
& \quad \times D^{ea'T}(x,0)\Gamma_3^T D^{ae'T}(x,x)]\text{Tr}[(\gamma_0\Gamma_3\gamma_0)S^{e'e'}(0,0)] \\
& + \Gamma_2 U^{cc'}(x,0)(\gamma_0\Gamma_2\gamma_0)\text{Tr}[\Gamma_1 S^{bb'}(x,0)(\gamma_0\Gamma_1\gamma_0) \\
& \quad \times D^{aa'T}(x,0)]\text{Tr}[\Gamma_3 D^{ee}(x,x)]\text{Tr}[(\gamma_0\Gamma_3\gamma_0)S^{e'e'}(0,0)] \\
& + \Gamma_2 S^{ce}(x,x)\Gamma_3 S^{e'e'}(x,0)(\gamma_0\Gamma_2\gamma_0)\text{Tr}[\Gamma_1 \\
& \quad \times D^{bb'}(x,0)(\gamma_0\Gamma_1\gamma_0)U^{e'a'T}(0,0)(\gamma_0\Gamma_3\gamma_0)^T U^{ae'T}(x,0)] \\
& - \Gamma_2 S^{ce}(x,x)\Gamma_3 S^{e'e'}(x,0)(\gamma_0\Gamma_2\gamma_0)\text{Tr}[\Gamma_1 \\
& \quad \times D^{bb'}(x,0)(\gamma_0\Gamma_1\gamma_0)U^{aa'T}(x,0)]\text{Tr}[(\gamma_0\Gamma_3\gamma_0)U^{e'e'}(0,0)] \\
& - \Gamma_2 S^{cc'}(x,0)(\gamma_0\Gamma_2\gamma_0)\text{Tr}[\Gamma_1 D^{bb'}(x,0)(\gamma_0\Gamma_1\gamma_0) \\
& \quad \times U^{e'a'T}(0,0)(\gamma_0\Gamma_3\gamma_0)^T U^{ae'T}(x,0)]\text{Tr}[\Gamma_3 S^{ee}(x,x)] \\
& + \Gamma_2 S^{cc'}(x,0)(\gamma_0\Gamma_2\gamma_0)\text{Tr}[\Gamma_1 D^{bb'}(x,0)(\gamma_0\Gamma_1\gamma_0) \\
& \quad \times U^{aa'T}(x,0)]\text{Tr}[\Gamma_3 S^{ee}(x,x)]\text{Tr}[(\gamma_0\Gamma_3\gamma_0)U^{e'e'}(0,0)] \\
& + \Gamma_2 S^{ce}(x,x)\Gamma_3 S^{e'b'}(x,0)(\gamma_0\Gamma_1\gamma_0)U^{e'a'T}(0,0)(\gamma_0\Gamma_3\gamma_0)^T \\
& \quad \times U^{ae'T}(x,0)\Gamma_1 D^{bc'}(x,0)(\gamma_0\Gamma_2\gamma_0) \\
& - \Gamma_2 S^{ce}(x,x)\Gamma_3 S^{e'b'}(x,0)(\gamma_0\Gamma_1\gamma_0)U^{aa'T}(x,0)\Gamma_1 \\
& \quad \times D^{bc'}(x,0)(\gamma_0\Gamma_2\gamma_0)\text{Tr}[(\gamma_0\Gamma_3\gamma_0)U^{e'e'}(0,0)] \\
& - \Gamma_2 S^{cb'}(x,0)(\gamma_0\Gamma_1\gamma_0)U^{e'a'T}(0,0)(\gamma_0\Gamma_3\gamma_0)^T U^{ae'T}(x,0)\Gamma_1 \\
& \quad \times D^{bc'}(x,0)(\gamma_0\Gamma_2\gamma_0)\text{Tr}[\Gamma_3 S^{ee}(x,x)] \\
& + \Gamma_2 S^{cb'}(x,0)(\gamma_0\Gamma_1\gamma_0)U^{aa'T}(x,0)\Gamma_1 D^{bc'}(x,0)(\gamma_0\Gamma_2\gamma_0) \\
& \quad \times \text{Tr}[\Gamma_3 S^{ee}(x,x)]\text{Tr}[(\gamma_0\Gamma_3\gamma_0)U^{e'e'}(0,0)] \\
& + \Gamma_2 S^{ce}(x,x)\Gamma_3 S^{e'b'}(x,0)(\gamma_0\Gamma_1\gamma_0)D^{ba'T}(x,0)\Gamma_1^T \\
& \quad \times U^{ae'}(x,0)(\gamma_0\Gamma_3\gamma_0)U^{e'e'}(0,0)(\gamma_0\Gamma_2\gamma_0) \\
& - \Gamma_2 S^{ce}(x,x)\Gamma_3 S^{e'b'}(x,0)(\gamma_0\Gamma_1\gamma_0)D^{ba'T}(x,0)\Gamma_1^T \\
& \quad \times U^{ac'}(x,0)(\gamma_0\Gamma_2\gamma_0)\text{Tr}[(\gamma_0\Gamma_3\gamma_0)U^{e'e'}(0,0)] \\
& - \Gamma_2 S^{cb'}(x,0)(\gamma_0\Gamma_1\gamma_0)D^{ba'T}(x,0)\Gamma_1^T U^{ae'}(x,0)(\gamma_0\Gamma_3\gamma_0) \\
& \quad \times U^{e'e'}(0,0)(\gamma_0\Gamma_2\gamma_0)\text{Tr}[\Gamma_3 S^{ee}(x,x)] \\
& + \Gamma_2 S^{cb'}(x,0)(\gamma_0\Gamma_1\gamma_0)D^{ba'T}(x,0)\Gamma_1^T U^{ac'}(x,0)(\gamma_0\Gamma_2\gamma_0) \\
& \quad \times \text{Tr}[\Gamma_3 S^{ee}(x,x)]\text{Tr}[(\gamma_0\Gamma_3\gamma_0)U^{e'e'}(0,0)]
\end{aligned}$$

$$\begin{aligned}
& + \Gamma_2 S^{ce}(x, x) \Gamma_3 S^{ec'}(x, 0) (\gamma_0 \Gamma_2 \gamma_0) \text{Tr} [\Gamma_1 \\
& \quad \times D^{be'}(x, 0) (\gamma_0 \Gamma_3 \gamma_0) D^{e'b'}(0, 0) (\gamma_0 \Gamma_1 \gamma_0) U^{aa'T}(x, 0)] \\
& - \Gamma_2 S^{ce}(x, x) \Gamma_3 S^{ec'}(x, 0) (\gamma_0 \Gamma_2 \gamma_0) \text{Tr} [\Gamma_1 \\
& \quad \times D^{bb'}(x, 0) (\gamma_0 \Gamma_1 \gamma_0) U^{aa'T}(x, 0)] \text{Tr} [(\gamma_0 \Gamma_3 \gamma_0) D^{e'e'}(0, 0)] \\
& - \Gamma_2 S^{cc'}(x, 0) (\gamma_0 \Gamma_2 \gamma_0) \text{Tr} [\Gamma_1 D^{be'}(x, 0) (\gamma_0 \Gamma_3 \gamma_0) \\
& \quad \times D^{e'b'}(0, 0) (\gamma_0 \Gamma_1 \gamma_0) U^{aa'T}(x, 0)] \text{Tr} [\Gamma_3 S^{ee}(x, x)] \\
& + \Gamma_2 S^{cc'}(x, 0) (\gamma_0 \Gamma_2 \gamma_0) \text{Tr} [\Gamma_1 D^{bb'}(x, 0) (\gamma_0 \Gamma_1 \gamma_0) \\
& \quad \times U^{aa'T}(x, 0)] \text{Tr} [\Gamma_3 S^{ee}(x, x)] \text{Tr} [(\gamma_0 \Gamma_3 \gamma_0) D^{e'e'}(0, 0)] \\
& + \Gamma_2 S^{ce}(x, x) \Gamma_3 S^{eb'}(x, 0) (\gamma_0 \Gamma_1 \gamma_0) U^{aa'T}(x, 0) \Gamma_1 \\
& \quad \times D^{be'}(x, 0) (\gamma_0 \Gamma_3 \gamma_0) D^{e'c'}(0, 0) (\gamma_0 \Gamma_2 \gamma_0) \\
& - \Gamma_2 S^{ce}(x, x) \Gamma_3 S^{eb'}(x, 0) (\gamma_0 \Gamma_1 \gamma_0) U^{aa'T}(x, 0) \Gamma_1 \\
& \quad \times D^{bc'}(x, 0) (\gamma_0 \Gamma_2 \gamma_0) \text{Tr} [(\gamma_0 \Gamma_3 \gamma_0) D^{e'e'}(0, 0)] \\
& - \Gamma_2 S^{cb'}(x, 0) (\gamma_0 \Gamma_1 \gamma_0) U^{aa'T}(x, 0) \Gamma_1 D^{be'}(x, 0) (\gamma_0 \Gamma_3 \gamma_0) \\
& \quad \times D^{e'c'}(0, 0) (\gamma_0 \Gamma_2 \gamma_0) \text{Tr} [\Gamma_3 S^{ee}(x, x)] \\
& + \Gamma_2 S^{cb'}(x, 0) (\gamma_0 \Gamma_1 \gamma_0) U^{aa'T}(x, 0) \Gamma_1 D^{bc'}(x, 0) (\gamma_0 \Gamma_2 \gamma_0) \\
& \quad \times \text{Tr} [\Gamma_3 S^{ee}(x, x)] \text{Tr} [(\gamma_0 \Gamma_3 \gamma_0) D^{e'e'}(0, 0)] \\
& + \Gamma_2 S^{ce}(x, x) \Gamma_3 S^{eb'}(x, 0) (\gamma_0 \Gamma_1 \gamma_0) D^{e'a'T}(0, 0) (\gamma_0 \Gamma_3 \gamma_0)^T \\
& \quad \times D^{be'T}(x, 0) \Gamma_1^T U^{ac'}(x, 0) (\gamma_0 \Gamma_2 \gamma_0) \\
& - \Gamma_2 S^{ce}(x, x) \Gamma_3 S^{eb'}(x, 0) (\gamma_0 \Gamma_1 \gamma_0) D^{ba'T}(x, 0) \Gamma_1^T \\
& \quad \times U^{ac'}(x, 0) (\gamma_0 \Gamma_2 \gamma_0) \text{Tr} [(\gamma_0 \Gamma_3 \gamma_0) D^{e'e'}(0, 0)] \\
& - \Gamma_2 S^{cb'}(x, 0) (\gamma_0 \Gamma_1 \gamma_0) D^{e'a'T}(0, 0) (\gamma_0 \Gamma_3 \gamma_0)^T D^{be'T}(x, 0) \Gamma_1^T \\
& \quad \times U^{ac'}(x, 0) (\gamma_0 \Gamma_2 \gamma_0) \text{Tr} [\Gamma_3 S^{ee}(x, x)] \\
& + \Gamma_2 S^{cb'}(x, 0) (\gamma_0 \Gamma_1 \gamma_0) D^{ba'T}(x, 0) \Gamma_1^T U^{ac'}(x, 0) (\gamma_0 \Gamma_2 \gamma_0) \\
& \quad \times \text{Tr} [\Gamma_3 S^{ee}(x, x)] \text{Tr} [(\gamma_0 \Gamma_3 \gamma_0) D^{e'e'}(0, 0)] \\
& + \Gamma_2 S^{ce}(x, x) \Gamma_3 S^{ee'}(x, 0) (\gamma_0 \Gamma_3 \gamma_0) S^{e'c'}(0, 0) (\gamma_0 \Gamma_2 \gamma_0) \\
& \quad \times \text{Tr} [\Gamma_1 D^{bb'}(x, 0) (\gamma_0 \Gamma_1 \gamma_0) U^{aa'T}(x, 0)] \\
& - \Gamma_2 S^{ce}(x, x) \Gamma_3 S^{ec'}(x, 0) (\gamma_0 \Gamma_2 \gamma_0) \text{Tr} [\Gamma_1 \\
& \quad \times D^{bb'}(x, 0) (\gamma_0 \Gamma_1 \gamma_0) U^{aa'T}(x, 0)] \text{Tr} [(\gamma_0 \Gamma_3 \gamma_0) S^{e'e'}(0, 0)] \\
& - \Gamma_2 S^{ce'}(x, 0) (\gamma_0 \Gamma_3 \gamma_0) S^{e'c'}(0, 0) (\gamma_0 \Gamma_2 \gamma_0) \text{Tr} [\Gamma_1 \\
& \quad \times D^{bb'}(x, 0) (\gamma_0 \Gamma_1 \gamma_0) U^{aa'T}(x, 0)] \text{Tr} [\Gamma_3 S^{ee}(x, x)] \\
& + \Gamma_2 S^{ce'}(x, 0) (\gamma_0 \Gamma_3 \gamma_0) S^{e'e}(0, x) \Gamma_3 S^{ec'}(x, 0) (\gamma_0 \Gamma_2 \gamma_0)
\end{aligned}$$

$$\begin{aligned}
& \times \text{Tr}[\Gamma_1 D^{bb'}(x, 0)(\gamma_0 \Gamma_1 \gamma_0) U^{aa'T}(x, 0)] \\
& + \Gamma_2 S^{ce'}(x, 0)(\gamma_0 \Gamma_2 \gamma_0) \text{Tr}[\Gamma_1 D^{bb'}(x, 0)(\gamma_0 \Gamma_1 \gamma_0) \\
& \quad \times U^{aa'T}(x, 0)] \text{Tr}[\Gamma_3 S^{ee}(x, x)] \text{Tr}[(\gamma_0 \Gamma_3 \gamma_0) S^{e'e'}(0, 0)] \\
& - \Gamma_2 S^{ce'}(x, 0)(\gamma_0 \Gamma_2 \gamma_0) \text{Tr}[\Gamma_1 D^{bb'}(x, 0)(\gamma_0 \Gamma_1 \gamma_0) \\
& \quad \times U^{aa'T}(x, 0)] \text{Tr}[\Gamma_3 S^{ee'}(x, 0)(\gamma_0 \Gamma_3 \gamma_0) S^{e'e}(0, x)] \\
& + \Gamma_2 S^{ce}(x, x) \Gamma_3 S^{ee'}(x, 0)(\gamma_0 \Gamma_3 \gamma_0) S^{e'b'}(0, 0)(\gamma_0 \Gamma_1 \gamma_0) \\
& \quad \times U^{aa'T}(x, 0) \Gamma_1 D^{bc'}(x, 0)(\gamma_0 \Gamma_2 \gamma_0) \\
& - \Gamma_2 S^{ce}(x, x) \Gamma_3 S^{eb'}(x, 0)(\gamma_0 \Gamma_1 \gamma_0) U^{aa'T}(x, 0) \Gamma_1 \\
& \quad \times D^{bc'}(x, 0)(\gamma_0 \Gamma_2 \gamma_0) \text{Tr}[(\gamma_0 \Gamma_3 \gamma_0) S^{e'e'}(0, 0)] \\
& - \Gamma_2 S^{ce'}(x, 0)(\gamma_0 \Gamma_3 \gamma_0) S^{e'b'}(0, 0)(\gamma_0 \Gamma_1 \gamma_0) U^{aa'T}(x, 0) \Gamma_1 \\
& \quad \times D^{bc'}(x, 0)(\gamma_0 \Gamma_2 \gamma_0) \text{Tr}[\Gamma_3 S^{ee}(x, x)] \\
& + \Gamma_2 S^{ce'}(x, 0)(\gamma_0 \Gamma_3 \gamma_0) S^{e'e}(0, x) \Gamma_3 S^{eb'}(x, 0)(\gamma_0 \Gamma_1 \gamma_0) \\
& \quad \times U^{aa'T}(x, 0) \Gamma_1 D^{bc'}(x, 0)(\gamma_0 \Gamma_2 \gamma_0) \\
& + \Gamma_2 S^{cb'}(x, 0)(\gamma_0 \Gamma_1 \gamma_0) U^{aa'T}(x, 0) \Gamma_1 D^{bc'}(x, 0)(\gamma_0 \Gamma_2 \gamma_0) \\
& \quad \times \text{Tr}[\Gamma_3 S^{ee}(x, x)] \text{Tr}[(\gamma_0 \Gamma_3 \gamma_0) S^{e'e'}(0, 0)] \\
& - \Gamma_2 S^{cb'}(x, 0)(\gamma_0 \Gamma_1 \gamma_0) U^{aa'T}(x, 0) \Gamma_1 D^{bc'}(x, 0)(\gamma_0 \Gamma_2 \gamma_0) \\
& \quad \times \text{Tr}[\Gamma_3 S^{ee'}(x, 0)(\gamma_0 \Gamma_3 \gamma_0) S^{e'e}(0, x)] \\
& + \Gamma_2 S^{ce}(x, x) \Gamma_3 S^{ee'}(x, 0)(\gamma_0 \Gamma_3 \gamma_0) S^{e'b'}(0, 0)(\gamma_0 \Gamma_1 \gamma_0) \\
& \quad \times D^{ba'T}(x, 0) \Gamma_1^T U^{ac'}(x, 0)(\gamma_0 \Gamma_2 \gamma_0) \\
& - \Gamma_2 S^{ce}(x, x) \Gamma_3 S^{eb'}(x, 0)(\gamma_0 \Gamma_1 \gamma_0) D^{ba'T}(x, 0) \Gamma_1^T \\
& \quad \times U^{ac'}(x, 0)(\gamma_0 \Gamma_2 \gamma_0) \text{Tr}[(\gamma_0 \Gamma_3 \gamma_0) S^{e'e'}(0, 0)] \\
& - \Gamma_2 S^{ce'}(x, 0)(\gamma_0 \Gamma_3 \gamma_0) S^{e'b'}(0, 0)(\gamma_0 \Gamma_1 \gamma_0) D^{ba'T}(x, 0) \Gamma_1^T \\
& \quad \times U^{ac'}(x, 0)(\gamma_0 \Gamma_2 \gamma_0) \text{Tr}[\Gamma_3 S^{ee}(x, x)] \\
& + \Gamma_2 S^{ce'}(x, 0)(\gamma_0 \Gamma_3 \gamma_0) S^{e'e}(0, x) \Gamma_3 S^{eb'}(x, 0)(\gamma_0 \Gamma_1 \gamma_0) \\
& \quad \times D^{ba'T}(x, 0) \Gamma_1^T U^{ac'}(x, 0)(\gamma_0 \Gamma_2 \gamma_0) \\
& + \Gamma_2 S^{cb'}(x, 0)(\gamma_0 \Gamma_1 \gamma_0) D^{ba'T}(x, 0) \Gamma_1^T U^{ac'}(x, 0)(\gamma_0 \Gamma_2 \gamma_0) \\
& \quad \times \text{Tr}[\Gamma_3 S^{ee}(x, x)] \text{Tr}[(\gamma_0 \Gamma_3 \gamma_0) S^{e'e'}(0, 0)] \\
& - \Gamma_2 S^{cb'}(x, 0)(\gamma_0 \Gamma_1 \gamma_0) D^{ba'T}(x, 0) \Gamma_1^T U^{ac'}(x, 0)(\gamma_0 \Gamma_2 \gamma_0) \\
& \quad \times \text{Tr}[\Gamma_3 S^{ee'}(x, 0)(\gamma_0 \Gamma_3 \gamma_0) S^{e'e}(0, x)] \\
& + \Gamma_2 D^{cb'}(x, 0)(\gamma_0 \Gamma_1 \gamma_0) U^{e'a'T}(0, 0)(\gamma_0 \Gamma_3 \gamma_0)^T U^{ae'T}(x, 0) \Gamma_1 \\
& \quad \times S^{be}(x, x) \Gamma_3 S^{ec'}(x, 0)(\gamma_0 \Gamma_2 \gamma_0)
\end{aligned}$$

$$\begin{aligned}
& -\Gamma_2 D^{cb'}(x, 0)(\gamma_0 \Gamma_1 \gamma_0) U^{aa'T}(x, 0) \Gamma_1 S^{be}(x, x) \Gamma_3 \\
& \quad \times S^{e'c'}(x, 0)(\gamma_0 \Gamma_2 \gamma_0) \text{Tr}[(\gamma_0 \Gamma_3 \gamma_0) U^{e'e'}(0, 0)] \\
& -\Gamma_2 D^{cb'}(x, 0)(\gamma_0 \Gamma_1 \gamma_0) U^{e'a'T}(0, 0)(\gamma_0 \Gamma_3 \gamma_0)^T U^{ae'T}(x, 0) \Gamma_1 \\
& \quad \times S^{bc'}(x, 0)(\gamma_0 \Gamma_2 \gamma_0) \text{Tr}[\Gamma_3 S^{ee}(x, x)] \\
& +\Gamma_2 D^{cb'}(x, 0)(\gamma_0 \Gamma_1 \gamma_0) U^{aa'T}(x, 0) \Gamma_1 S^{bc'}(x, 0)(\gamma_0 \Gamma_2 \gamma_0) \\
& \quad \times \text{Tr}[\Gamma_3 S^{ee}(x, x)] \text{Tr}[(\gamma_0 \Gamma_3 \gamma_0) U^{e'e'}(0, 0)] \\
& +\Gamma_2 D^{cc'}(x, 0)(\gamma_0 \Gamma_2 \gamma_0) \text{Tr}[\Gamma_1 S^{be}(x, x) \Gamma_3 \\
& \quad \times S^{eb'}(x, 0)(\gamma_0 \Gamma_1 \gamma_0) U^{e'a'T}(0, 0)(\gamma_0 \Gamma_3 \gamma_0)^T U^{ae'T}(x, 0)] \\
& -\Gamma_2 D^{cc'}(x, 0)(\gamma_0 \Gamma_2 \gamma_0) \text{Tr}[\Gamma_1 S^{be}(x, x) \Gamma_3 \\
& \quad \times S^{eb'}(x, 0)(\gamma_0 \Gamma_1 \gamma_0) U^{aa'T}(x, 0)] \text{Tr}[(\gamma_0 \Gamma_3 \gamma_0) U^{e'e'}(0, 0)] \\
& -\Gamma_2 D^{cc'}(x, 0)(\gamma_0 \Gamma_2 \gamma_0) \text{Tr}[\Gamma_1 S^{bb'}(x, 0)(\gamma_0 \Gamma_1 \gamma_0) \\
& \quad \times U^{e'a'T}(0, 0)(\gamma_0 \Gamma_3 \gamma_0)^T U^{ae'T}(x, 0)] \text{Tr}[\Gamma_3 S^{ee}(x, x)] \\
& +\Gamma_2 D^{cc'}(x, 0)(\gamma_0 \Gamma_2 \gamma_0) \text{Tr}[\Gamma_1 S^{bb'}(x, 0)(\gamma_0 \Gamma_1 \gamma_0) \\
& \quad \times U^{aa'T}(x, 0)] \text{Tr}[\Gamma_3 S^{ee}(x, x)] \text{Tr}[(\gamma_0 \Gamma_3 \gamma_0) U^{e'e'}(0, 0)] \\
& +\Gamma_2 D^{ca'}(x, 0)(\gamma_0 \Gamma_1 \gamma_0)^T S^{eb'T}(x, 0) \Gamma_3^T S^{be^T}(x, x) \Gamma_1^T \\
& \quad \times U^{ae'}(x, 0)(\gamma_0 \Gamma_3 \gamma_0) U^{e'c'}(0, 0)(\gamma_0 \Gamma_2 \gamma_0) \\
& -\Gamma_2 D^{ca'}(x, 0)(\gamma_0 \Gamma_1 \gamma_0)^T S^{eb'T}(x, 0) \Gamma_3^T S^{be^T}(x, x) \Gamma_1^T \\
& \quad \times U^{ac'}(x, 0)(\gamma_0 \Gamma_2 \gamma_0) \text{Tr}[(\gamma_0 \Gamma_3 \gamma_0) U^{e'e'}(0, 0)] \\
& -\Gamma_2 D^{ca'}(x, 0)(\gamma_0 \Gamma_1 \gamma_0)^T S^{bb'T}(x, 0) \Gamma_1^T U^{ae'}(x, 0)(\gamma_0 \Gamma_3 \gamma_0) \\
& \quad \times U^{e'c'}(0, 0)(\gamma_0 \Gamma_2 \gamma_0) \text{Tr}[\Gamma_3 S^{ee}(x, x)] \\
& +\Gamma_2 D^{ca'}(x, 0)(\gamma_0 \Gamma_1 \gamma_0)^T S^{bb'T}(x, 0) \Gamma_1^T U^{ac'}(x, 0)(\gamma_0 \Gamma_2 \gamma_0) \\
& \quad \times \text{Tr}[\Gamma_3 S^{ee}(x, x)] \text{Tr}[(\gamma_0 \Gamma_3 \gamma_0) U^{e'e'}(0, 0)] \\
& +\Gamma_2 D^{ce'}(x, 0)(\gamma_0 \Gamma_3 \gamma_0) D^{e'b'}(0, 0)(\gamma_0 \Gamma_1 \gamma_0) U^{aa'T}(x, 0) \Gamma_1 \\
& \quad \times S^{be}(x, x) \Gamma_3 S^{ec'}(x, 0)(\gamma_0 \Gamma_2 \gamma_0) \\
& -\Gamma_2 D^{cb'}(x, 0)(\gamma_0 \Gamma_1 \gamma_0) U^{aa'T}(x, 0) \Gamma_1 S^{be}(x, x) \Gamma_3 \\
& \quad \times S^{e'c'}(x, 0)(\gamma_0 \Gamma_2 \gamma_0) \text{Tr}[(\gamma_0 \Gamma_3 \gamma_0) D^{e'e'}(0, 0)] \\
& -\Gamma_2 D^{ce'}(x, 0)(\gamma_0 \Gamma_3 \gamma_0) D^{e'b'}(0, 0)(\gamma_0 \Gamma_1 \gamma_0) U^{aa'T}(x, 0) \Gamma_1 \\
& \quad \times S^{bc'}(x, 0)(\gamma_0 \Gamma_2 \gamma_0) \text{Tr}[\Gamma_3 S^{ee}(x, x)] \\
& +\Gamma_2 D^{cb'}(x, 0)(\gamma_0 \Gamma_1 \gamma_0) U^{aa'T}(x, 0) \Gamma_1 S^{bc'}(x, 0)(\gamma_0 \Gamma_2 \gamma_0) \\
& \quad \times \text{Tr}[\Gamma_3 S^{ee}(x, x)] \text{Tr}[(\gamma_0 \Gamma_3 \gamma_0) D^{e'e'}(0, 0)] \\
& +\Gamma_2 D^{ce'}(x, 0)(\gamma_0 \Gamma_3 \gamma_0) D^{e'c'}(0, 0)(\gamma_0 \Gamma_2 \gamma_0) \text{Tr}[\Gamma_1
\end{aligned}$$

$$\begin{aligned}
& \times S^{be}(x, x)\Gamma_3 S^{eb'}(x, 0)(\gamma_0\Gamma_1\gamma_0)U^{aa'T}(x, 0)] \\
& - \Gamma_2 D^{cc'}(x, 0)(\gamma_0\Gamma_2\gamma_0)\text{Tr}[\Gamma_1 S^{be}(x, x)\Gamma_3 \\
& \quad \times S^{eb'}(x, 0)(\gamma_0\Gamma_1\gamma_0)U^{aa'T}(x, 0)]\text{Tr}[(\gamma_0\Gamma_3\gamma_0)D^{e'e'}(0, 0)] \\
& - \Gamma_2 D^{cc'}(x, 0)(\gamma_0\Gamma_3\gamma_0)D^{e'e'}(0, 0)(\gamma_0\Gamma_2\gamma_0)\text{Tr}[\Gamma_1 \\
& \quad \times S^{bb'}(x, 0)(\gamma_0\Gamma_1\gamma_0)U^{aa'T}(x, 0)]\text{Tr}[\Gamma_3 S^{ee}(x, x)] \\
& + \Gamma_2 D^{cc'}(x, 0)(\gamma_0\Gamma_2\gamma_0)\text{Tr}[\Gamma_1 S^{bb'}(x, 0)(\gamma_0\Gamma_1\gamma_0) \\
& \quad \times U^{aa'T}(x, 0)]\text{Tr}[\Gamma_3 S^{ee}(x, x)]\text{Tr}[(\gamma_0\Gamma_3\gamma_0)D^{e'e'}(0, 0)] \\
& + \Gamma_2 D^{cc'}(x, 0)(\gamma_0\Gamma_3\gamma_0)D^{e'a'}(0, 0)(\gamma_0\Gamma_1\gamma_0)^T S^{eb'T}(x, 0)\Gamma_3^T \\
& \quad \times S^{be^T}(x, x)\Gamma_1^T U^{ac'}(x, 0)(\gamma_0\Gamma_2\gamma_0) \\
& - \Gamma_2 D^{ca'}(x, 0)(\gamma_0\Gamma_1\gamma_0)^T S^{eb'T}(x, 0)\Gamma_3^T S^{be^T}(x, x)\Gamma_1^T \\
& \quad \times U^{ac'}(x, 0)(\gamma_0\Gamma_2\gamma_0)\text{Tr}[(\gamma_0\Gamma_3\gamma_0)D^{e'e'}(0, 0)] \\
& - \Gamma_2 D^{cc'}(x, 0)(\gamma_0\Gamma_3\gamma_0)D^{e'a'}(0, 0)(\gamma_0\Gamma_1\gamma_0)^T S^{bb'T}(x, 0)\Gamma_1^T \\
& \quad \times U^{ac'}(x, 0)(\gamma_0\Gamma_2\gamma_0)\text{Tr}[\Gamma_3 S^{ee}(x, x)] \\
& + \Gamma_2 D^{ca'}(x, 0)(\gamma_0\Gamma_1\gamma_0)^T S^{bb'T}(x, 0)\Gamma_1^T U^{ac'}(x, 0)(\gamma_0\Gamma_2\gamma_0) \\
& \quad \times \text{Tr}[\Gamma_3 S^{ee}(x, x)]\text{Tr}[(\gamma_0\Gamma_3\gamma_0)D^{e'e'}(0, 0)] \\
& + \Gamma_2 D^{cb'}(x, 0)(\gamma_0\Gamma_1\gamma_0)U^{aa'T}(x, 0)\Gamma_1 S^{be}(x, x)\Gamma_3 \\
& \quad \times S^{e'e'}(x, 0)(\gamma_0\Gamma_3\gamma_0)S^{e'e'}(0, 0)(\gamma_0\Gamma_2\gamma_0) \\
& - \Gamma_2 D^{cb'}(x, 0)(\gamma_0\Gamma_1\gamma_0)U^{aa'T}(x, 0)\Gamma_1 S^{be}(x, x)\Gamma_3 \\
& \quad \times S^{e'e'}(x, 0)(\gamma_0\Gamma_2\gamma_0)\text{Tr}[(\gamma_0\Gamma_3\gamma_0)S^{e'e'}(0, 0)] \\
& - \Gamma_2 D^{cb'}(x, 0)(\gamma_0\Gamma_1\gamma_0)U^{aa'T}(x, 0)\Gamma_1 S^{be'}(x, 0)(\gamma_0\Gamma_3\gamma_0) \\
& \quad \times S^{e'e'}(0, 0)(\gamma_0\Gamma_2\gamma_0)\text{Tr}[\Gamma_3 S^{ee}(x, x)] \\
& + \Gamma_2 D^{cb'}(x, 0)(\gamma_0\Gamma_1\gamma_0)U^{aa'T}(x, 0)\Gamma_1 S^{be'}(x, 0)(\gamma_0\Gamma_3\gamma_0) \\
& \quad \times S^{e'e'}(0, x)\Gamma_3 S^{e'e'}(x, 0)(\gamma_0\Gamma_2\gamma_0) \\
& + \Gamma_2 D^{cb'}(x, 0)(\gamma_0\Gamma_1\gamma_0)U^{aa'T}(x, 0)\Gamma_1 S^{bc'}(x, 0)(\gamma_0\Gamma_2\gamma_0) \\
& \quad \times \text{Tr}[\Gamma_3 S^{ee}(x, x)]\text{Tr}[(\gamma_0\Gamma_3\gamma_0)S^{e'e'}(0, 0)] \\
& - \Gamma_2 D^{cb'}(x, 0)(\gamma_0\Gamma_1\gamma_0)U^{aa'T}(x, 0)\Gamma_1 S^{bc'}(x, 0)(\gamma_0\Gamma_2\gamma_0) \\
& \quad \times \text{Tr}[\Gamma_3 S^{e'e'}(x, 0)(\gamma_0\Gamma_3\gamma_0)S^{e'e'}(0, x)] \\
& + \Gamma_2 D^{cc'}(x, 0)(\gamma_0\Gamma_2\gamma_0)\text{Tr}[\Gamma_1 S^{be}(x, x)\Gamma_3 \\
& \quad \times S^{e'e'}(x, 0)(\gamma_0\Gamma_3\gamma_0)S^{e'b'}(0, 0)(\gamma_0\Gamma_1\gamma_0)U^{aa'T}(x, 0)] \\
& - \Gamma_2 D^{cc'}(x, 0)(\gamma_0\Gamma_2\gamma_0)\text{Tr}[\Gamma_1 S^{be}(x, x)\Gamma_3 \\
& \quad \times S^{eb'}(x, 0)(\gamma_0\Gamma_1\gamma_0)U^{aa'T}(x, 0)]\text{Tr}[(\gamma_0\Gamma_3\gamma_0)S^{e'e'}(0, 0)]
\end{aligned}$$

$$\begin{aligned}
& -\Gamma_2 D^{cc'}(x, 0)(\gamma_0 \Gamma_2 \gamma_0) \text{Tr} [\Gamma_1 S^{be'}(x, 0)(\gamma_0 \Gamma_3 \gamma_0) \\
& \quad \times S^{e'b'}(0, 0)(\gamma_0 \Gamma_1 \gamma_0) U^{aa'T}(x, 0)] \text{Tr} [\Gamma_3 S^{ee}(x, x)] \\
& + \Gamma_2 D^{cc'}(x, 0)(\gamma_0 \Gamma_2 \gamma_0) \text{Tr} [\Gamma_1 S^{be'}(x, 0)(\gamma_0 \Gamma_3 \gamma_0) \\
& \quad \times S^{e'e}(0, x) \Gamma_3 S^{eb'}(x, 0)(\gamma_0 \Gamma_1 \gamma_0) U^{aa'T}(x, 0)] \\
& + \Gamma_2 D^{cc'}(x, 0)(\gamma_0 \Gamma_2 \gamma_0) \text{Tr} [\Gamma_1 S^{bb'}(x, 0)(\gamma_0 \Gamma_1 \gamma_0) \\
& \quad \times U^{aa'T}(x, 0)] \text{Tr} [\Gamma_3 S^{ee}(x, x)] \text{Tr} [(\gamma_0 \Gamma_3 \gamma_0) S^{e'e'}(0, 0)] \\
& - \Gamma_2 D^{cc'}(x, 0)(\gamma_0 \Gamma_2 \gamma_0) \text{Tr} [\Gamma_1 S^{bb'}(x, 0)(\gamma_0 \Gamma_1 \gamma_0) \\
& \quad \times U^{aa'T}(x, 0)] \text{Tr} [\Gamma_3 S^{ee'}(x, 0)(\gamma_0 \Gamma_3 \gamma_0) S^{e'e}(0, x)] \\
& + \Gamma_2 D^{ca'}(x, 0)(\gamma_0 \Gamma_1 \gamma_0)^T S^{e'b'T}(0, 0)(\gamma_0 \Gamma_3 \gamma_0)^T S^{ee'T}(x, 0) \Gamma_3^T \\
& \quad \times S^{be^T}(x, x) \Gamma_1^T U^{ac'}(x, 0)(\gamma_0 \Gamma_2 \gamma_0) \\
& - \Gamma_2 D^{ca'}(x, 0)(\gamma_0 \Gamma_1 \gamma_0)^T S^{eb'T}(x, 0) \Gamma_3^T S^{be^T}(x, x) \Gamma_1^T \\
& \quad \times U^{ac'}(x, 0)(\gamma_0 \Gamma_2 \gamma_0) \text{Tr} [(\gamma_0 \Gamma_3 \gamma_0) S^{e'e'}(0, 0)] \\
& - \Gamma_2 D^{ca'}(x, 0)(\gamma_0 \Gamma_1 \gamma_0)^T S^{e'b'T}(0, 0)(\gamma_0 \Gamma_3 \gamma_0)^T S^{be^T}(x, 0) \Gamma_1^T \\
& \quad \times U^{ac'}(x, 0)(\gamma_0 \Gamma_2 \gamma_0) \text{Tr} [\Gamma_3 S^{ee}(x, x)] \\
& + \Gamma_2 D^{ca'}(x, 0)(\gamma_0 \Gamma_1 \gamma_0)^T S^{eb'T}(x, 0) \Gamma_3^T S^{e'e^T}(0, x)(\gamma_0 \Gamma_3 \gamma_0)^T \\
& \quad \times S^{be^T}(x, 0) \Gamma_1^T U^{ac'}(x, 0)(\gamma_0 \Gamma_2 \gamma_0) \\
& + \Gamma_2 D^{ca'}(x, 0)(\gamma_0 \Gamma_1 \gamma_0)^T S^{bb^T}(x, 0) \Gamma_1^T U^{ac'}(x, 0)(\gamma_0 \Gamma_2 \gamma_0) \\
& \quad \times \text{Tr} [\Gamma_3 S^{ee}(x, x)] \text{Tr} [(\gamma_0 \Gamma_3 \gamma_0) S^{e'e'}(0, 0)] \\
& - \Gamma_2 D^{ca'}(x, 0)(\gamma_0 \Gamma_1 \gamma_0)^T S^{bb^T}(x, 0) \Gamma_1^T U^{ac'}(x, 0)(\gamma_0 \Gamma_2 \gamma_0) \\
& \quad \times \text{Tr} [\Gamma_3 S^{ee'}(x, 0)(\gamma_0 \Gamma_3 \gamma_0) S^{e'e}(0, x)] \\
& + \Gamma_2 U^{ce'}(x, 0)(\gamma_0 \Gamma_3 \gamma_0) U^{e'a'}(0, 0)(\gamma_0 \Gamma_1 \gamma_0)^T D^{ab^T}(x, 0) \Gamma_1 \\
& \quad \times S^{be}(x, x) \Gamma_3 S^{ec'}(x, 0)(\gamma_0 \Gamma_2 \gamma_0) \\
& - \Gamma_2 U^{ca'}(x, 0)(\gamma_0 \Gamma_1 \gamma_0)^T D^{ab^T}(x, 0) \Gamma_1 S^{be}(x, x) \Gamma_3 \\
& \quad \times S^{ec'}(x, 0)(\gamma_0 \Gamma_2 \gamma_0) \text{Tr} [(\gamma_0 \Gamma_3 \gamma_0) U^{e'e'}(0, 0)] \\
& - \Gamma_2 U^{ce'}(x, 0)(\gamma_0 \Gamma_3 \gamma_0) U^{e'a'}(0, 0)(\gamma_0 \Gamma_1 \gamma_0)^T D^{ab^T}(x, 0) \Gamma_1 \\
& \quad \times S^{bc'}(x, 0)(\gamma_0 \Gamma_2 \gamma_0) \text{Tr} [\Gamma_3 S^{ee}(x, x)] \\
& + \Gamma_2 U^{ca'}(x, 0)(\gamma_0 \Gamma_1 \gamma_0)^T D^{ab^T}(x, 0) \Gamma_1 S^{bc'}(x, 0)(\gamma_0 \Gamma_2 \gamma_0) \\
& \quad \times \text{Tr} [\Gamma_3 S^{ee}(x, x)] \text{Tr} [(\gamma_0 \Gamma_3 \gamma_0) U^{e'e'}(0, 0)] \\
& + \Gamma_2 U^{ce'}(x, 0)(\gamma_0 \Gamma_3 \gamma_0) U^{e'a'}(0, 0)(\gamma_0 \Gamma_1 \gamma_0)^T S^{eb^T}(x, 0) \Gamma_3^T \\
& \quad \times S^{be^T}(x, x) \Gamma_1^T D^{ac'}(x, 0)(\gamma_0 \Gamma_2 \gamma_0) \\
& - \Gamma_2 U^{ca'}(x, 0)(\gamma_0 \Gamma_1 \gamma_0)^T S^{eb^T}(x, 0) \Gamma_3^T S^{be^T}(x, x) \Gamma_1^T
\end{aligned}$$

$$\begin{aligned}
& \times D^{ac'}(x, 0)(\gamma_0 \Gamma_2 \gamma_0) \text{Tr}[(\gamma_0 \Gamma_3 \gamma_0) U^{e'e'}(0, 0)] \\
& - \Gamma_2 U^{ce'}(x, 0)(\gamma_0 \Gamma_3 \gamma_0) U^{e'a'}(0, 0)(\gamma_0 \Gamma_1 \gamma_0)^T S^{bb'T}(x, 0) \Gamma_1^T \\
& \quad \times D^{ac'}(x, 0)(\gamma_0 \Gamma_2 \gamma_0) \text{Tr}[\Gamma_3 S^{ee}(x, x)] \\
& + \Gamma_2 U^{ca'}(x, 0)(\gamma_0 \Gamma_1 \gamma_0)^T S^{bb'T}(x, 0) \Gamma_1^T D^{ac'}(x, 0)(\gamma_0 \Gamma_2 \gamma_0) \\
& \quad \times \text{Tr}[\Gamma_3 S^{ee}(x, x)] \text{Tr}[(\gamma_0 \Gamma_3 \gamma_0) U^{e'e'}(0, 0)] \\
& + \Gamma_2 U^{ce'}(x, 0)(\gamma_0 \Gamma_3 \gamma_0) U^{e'c'}(0, 0)(\gamma_0 \Gamma_2 \gamma_0) \text{Tr}[\Gamma_1 \\
& \quad \times S^{be}(x, x) \Gamma_3 S^{eb'}(x, 0)(\gamma_0 \Gamma_1 \gamma_0) D^{aa'T}(x, 0)] \\
& - \Gamma_2 U^{cc'}(x, 0)(\gamma_0 \Gamma_2 \gamma_0) \text{Tr}[\Gamma_1 S^{be}(x, x) \Gamma_3 \\
& \quad \times S^{eb'}(x, 0)(\gamma_0 \Gamma_1 \gamma_0) D^{aa'T}(x, 0)] \text{Tr}[(\gamma_0 \Gamma_3 \gamma_0) U^{e'e'}(0, 0)] \\
& - \Gamma_2 U^{cc'}(x, 0)(\gamma_0 \Gamma_3 \gamma_0) U^{e'c'}(0, 0)(\gamma_0 \Gamma_2 \gamma_0) \text{Tr}[\Gamma_1 \\
& \quad \times S^{bb'}(x, 0)(\gamma_0 \Gamma_1 \gamma_0) D^{aa'T}(x, 0)] \text{Tr}[\Gamma_3 S^{ee}(x, x)] \\
& + \Gamma_2 U^{cc'}(x, 0)(\gamma_0 \Gamma_2 \gamma_0) \text{Tr}[\Gamma_1 S^{bb'}(x, 0)(\gamma_0 \Gamma_1 \gamma_0) \\
& \quad \times D^{aa'T}(x, 0)] \text{Tr}[\Gamma_3 S^{ee}(x, x)] \text{Tr}[(\gamma_0 \Gamma_3 \gamma_0) U^{e'e'}(0, 0)] \\
& + \Gamma_2 U^{ca'}(x, 0)(\gamma_0 \Gamma_1 \gamma_0)^T D^{e'b'T}(0, 0)(\gamma_0 \Gamma_3 \gamma_0)^T D^{ae'T}(x, 0) \Gamma_1 \\
& \quad \times S^{be}(x, x) \Gamma_3 S^{ec'}(x, 0)(\gamma_0 \Gamma_2 \gamma_0) \\
& - \Gamma_2 U^{ca'}(x, 0)(\gamma_0 \Gamma_1 \gamma_0)^T D^{ab'T}(x, 0) \Gamma_1 S^{be}(x, x) \Gamma_3 \\
& \quad \times S^{ec'}(x, 0)(\gamma_0 \Gamma_2 \gamma_0) \text{Tr}[(\gamma_0 \Gamma_3 \gamma_0) D^{e'e'}(0, 0)] \\
& - \Gamma_2 U^{ca'}(x, 0)(\gamma_0 \Gamma_1 \gamma_0)^T D^{e'b'T}(0, 0)(\gamma_0 \Gamma_3 \gamma_0)^T D^{ae'T}(x, 0) \Gamma_1 \\
& \quad \times S^{bc'}(x, 0)(\gamma_0 \Gamma_2 \gamma_0) \text{Tr}[\Gamma_3 S^{ee}(x, x)] \\
& + \Gamma_2 U^{ca'}(x, 0)(\gamma_0 \Gamma_1 \gamma_0)^T D^{ab'T}(x, 0) \Gamma_1 S^{bc'}(x, 0)(\gamma_0 \Gamma_2 \gamma_0) \\
& \quad \times \text{Tr}[\Gamma_3 S^{ee}(x, x)] \text{Tr}[(\gamma_0 \Gamma_3 \gamma_0) D^{e'e'}(0, 0)] \\
& + \Gamma_2 U^{ca'}(x, 0)(\gamma_0 \Gamma_1 \gamma_0)^T S^{eb'T}(x, 0) \Gamma_3^T S^{be'T}(x, x) \Gamma_1^T \\
& \quad \times D^{ae'}(x, 0)(\gamma_0 \Gamma_3 \gamma_0) D^{e'c'}(0, 0)(\gamma_0 \Gamma_2 \gamma_0) \\
& - \Gamma_2 U^{ca'}(x, 0)(\gamma_0 \Gamma_1 \gamma_0)^T S^{eb'T}(x, 0) \Gamma_3^T S^{be'T}(x, x) \Gamma_1^T \\
& \quad \times D^{ac'}(x, 0)(\gamma_0 \Gamma_2 \gamma_0) \text{Tr}[(\gamma_0 \Gamma_3 \gamma_0) D^{e'e'}(0, 0)] \\
& - \Gamma_2 U^{ca'}(x, 0)(\gamma_0 \Gamma_1 \gamma_0)^T S^{bb'T}(x, 0) \Gamma_1^T D^{ae'}(x, 0)(\gamma_0 \Gamma_3 \gamma_0) \\
& \quad \times D^{e'c'}(0, 0)(\gamma_0 \Gamma_2 \gamma_0) \text{Tr}[\Gamma_3 S^{ee}(x, x)] \\
& + \Gamma_2 U^{ca'}(x, 0)(\gamma_0 \Gamma_1 \gamma_0)^T S^{bb'T}(x, 0) \Gamma_1^T D^{ac'}(x, 0)(\gamma_0 \Gamma_2 \gamma_0) \\
& \quad \times \text{Tr}[\Gamma_3 S^{ee}(x, x)] \text{Tr}[(\gamma_0 \Gamma_3 \gamma_0) D^{e'e'}(0, 0)] \\
& + \Gamma_2 U^{cc'}(x, 0)(\gamma_0 \Gamma_2 \gamma_0) \text{Tr}[\Gamma_1 S^{be}(x, x) \Gamma_3 \\
& \quad \times S^{eb'}(x, 0)(\gamma_0 \Gamma_1 \gamma_0) D^{e'a'T}(0, 0)(\gamma_0 \Gamma_3 \gamma_0)^T D^{ae'T}(x, 0)]
\end{aligned}$$

$$\begin{aligned}
& - \Gamma_2 U^{cc'}(x, 0)(\gamma_0 \Gamma_2 \gamma_0) \text{Tr} [\Gamma_1 S^{be}(x, x) \Gamma_3 \\
& \quad \times S^{eb'}(x, 0)(\gamma_0 \Gamma_1 \gamma_0) D^{aa'T}(x, 0)] \text{Tr} [(\gamma_0 \Gamma_3 \gamma_0) D^{e'e'}(0, 0)] \\
& - \Gamma_2 U^{cc'}(x, 0)(\gamma_0 \Gamma_2 \gamma_0) \text{Tr} [\Gamma_1 S^{bb'}(x, 0)(\gamma_0 \Gamma_1 \gamma_0) \\
& \quad \times D^{e'a'T}(0, 0)(\gamma_0 \Gamma_3 \gamma_0)^T D^{ae'T}(x, 0)] \text{Tr} [\Gamma_3 S^{ee}(x, x)] \\
& + \Gamma_2 U^{cc'}(x, 0)(\gamma_0 \Gamma_2 \gamma_0) \text{Tr} [\Gamma_1 S^{bb'}(x, 0)(\gamma_0 \Gamma_1 \gamma_0) \\
& \quad \times D^{aa'T}(x, 0)] \text{Tr} [\Gamma_3 S^{ee}(x, x)] \text{Tr} [(\gamma_0 \Gamma_3 \gamma_0) D^{e'e'}(0, 0)] \\
& + \Gamma_2 U^{ca'}(x, 0)(\gamma_0 \Gamma_1 \gamma_0)^T D^{ab'T}(x, 0) \Gamma_1 S^{be}(x, x) \Gamma_3 \\
& \quad \times S^{e'e'}(x, 0)(\gamma_0 \Gamma_3 \gamma_0) S^{e'c'}(0, 0)(\gamma_0 \Gamma_2 \gamma_0) \\
& - \Gamma_2 U^{ca'}(x, 0)(\gamma_0 \Gamma_1 \gamma_0)^T D^{ab'T}(x, 0) \Gamma_1 S^{be}(x, x) \Gamma_3 \\
& \quad \times S^{e'e'}(x, 0)(\gamma_0 \Gamma_2 \gamma_0) \text{Tr} [(\gamma_0 \Gamma_3 \gamma_0) S^{e'e'}(0, 0)] \\
& - \Gamma_2 U^{ca'}(x, 0)(\gamma_0 \Gamma_1 \gamma_0)^T D^{ab'T}(x, 0) \Gamma_1 S^{be'}(x, 0)(\gamma_0 \Gamma_3 \gamma_0) \\
& \quad \times S^{e'e'}(0, 0)(\gamma_0 \Gamma_2 \gamma_0) \text{Tr} [\Gamma_3 S^{ee}(x, x)] \\
& + \Gamma_2 U^{ca'}(x, 0)(\gamma_0 \Gamma_1 \gamma_0)^T D^{ab'T}(x, 0) \Gamma_1 S^{be'}(x, 0)(\gamma_0 \Gamma_3 \gamma_0) \\
& \quad \times S^{e'e}(0, x) \Gamma_3 S^{ec'}(x, 0)(\gamma_0 \Gamma_2 \gamma_0) \\
& + \Gamma_2 U^{ca'}(x, 0)(\gamma_0 \Gamma_1 \gamma_0)^T D^{ab'T}(x, 0) \Gamma_1 S^{be'}(x, 0)(\gamma_0 \Gamma_2 \gamma_0) \\
& \quad \times \text{Tr} [\Gamma_3 S^{ee}(x, x)] \text{Tr} [(\gamma_0 \Gamma_3 \gamma_0) S^{e'e'}(0, 0)] \\
& - \Gamma_2 U^{ca'}(x, 0)(\gamma_0 \Gamma_1 \gamma_0)^T D^{ab'T}(x, 0) \Gamma_1 S^{bc'}(x, 0)(\gamma_0 \Gamma_2 \gamma_0) \\
& \quad \times \text{Tr} [\Gamma_3 S^{ee'}(x, 0)(\gamma_0 \Gamma_3 \gamma_0) S^{e'e}(0, x)] \\
& + \Gamma_2 U^{ca'}(x, 0)(\gamma_0 \Gamma_1 \gamma_0)^T S^{e'b'T}(0, 0)(\gamma_0 \Gamma_3 \gamma_0)^T S^{ee'T}(x, 0) \Gamma_3^T \\
& \quad \times S^{be'T}(x, x) \Gamma_1^T D^{ac'}(x, 0)(\gamma_0 \Gamma_2 \gamma_0) \\
& - \Gamma_2 U^{ca'}(x, 0)(\gamma_0 \Gamma_1 \gamma_0)^T S^{e'b'T}(x, 0) \Gamma_3^T S^{be'T}(x, x) \Gamma_1^T \\
& \quad \times D^{ac'}(x, 0)(\gamma_0 \Gamma_2 \gamma_0) \text{Tr} [(\gamma_0 \Gamma_3 \gamma_0) S^{e'e'}(0, 0)] \\
& - \Gamma_2 U^{ca'}(x, 0)(\gamma_0 \Gamma_1 \gamma_0)^T S^{e'b'T}(0, 0)(\gamma_0 \Gamma_3 \gamma_0)^T S^{be'T}(x, 0) \Gamma_1^T \\
& \quad \times D^{ac'}(x, 0)(\gamma_0 \Gamma_2 \gamma_0) \text{Tr} [\Gamma_3 S^{ee}(x, x)] \\
& + \Gamma_2 U^{ca'}(x, 0)(\gamma_0 \Gamma_1 \gamma_0)^T S^{eb'T}(x, 0) \Gamma_3^T S^{e'e'T}(0, x)(\gamma_0 \Gamma_3 \gamma_0)^T \\
& \quad \times S^{be'T}(x, 0) \Gamma_1^T D^{ac'}(x, 0)(\gamma_0 \Gamma_2 \gamma_0) \\
& + \Gamma_2 U^{ca'}(x, 0)(\gamma_0 \Gamma_1 \gamma_0)^T S^{bb'T}(x, 0) \Gamma_1^T D^{ac'}(x, 0)(\gamma_0 \Gamma_2 \gamma_0) \\
& \quad \times \text{Tr} [\Gamma_3 S^{ee}(x, x)] \text{Tr} [(\gamma_0 \Gamma_3 \gamma_0) S^{e'e'}(0, 0)] \\
& - \Gamma_2 U^{ca'}(x, 0)(\gamma_0 \Gamma_1 \gamma_0)^T S^{bb'T}(x, 0) \Gamma_1^T D^{ac'}(x, 0)(\gamma_0 \Gamma_2 \gamma_0) \\
& \quad \times \text{Tr} [\Gamma_3 S^{ee'}(x, 0)(\gamma_0 \Gamma_3 \gamma_0) S^{e'e}(0, x)] \\
& + \Gamma_2 U^{cc'}(x, 0)(\gamma_0 \Gamma_2 \gamma_0) \text{Tr} [\Gamma_1 S^{be}(x, x) \Gamma_3
\end{aligned}$$



$$\begin{aligned}
& \times S^{ee'}(x, 0)(\gamma_0 \Gamma_3 \gamma_0) S^{e'b'}(0, 0)(\gamma_0 \Gamma_1 \gamma_0) D^{aa'T}(x, 0) \\
& - \Gamma_2 U^{cc'}(x, 0)(\gamma_0 \Gamma_2 \gamma_0) \text{Tr}[\Gamma_1 S^{be}(x, x) \Gamma_3 \\
& \quad \times S^{eb'}(x, 0)(\gamma_0 \Gamma_1 \gamma_0) D^{aa'T}(x, 0)] \text{Tr}[(\gamma_0 \Gamma_3 \gamma_0) S^{e'e'}(0, 0)] \\
& - \Gamma_2 U^{cc'}(x, 0)(\gamma_0 \Gamma_2 \gamma_0) \text{Tr}[\Gamma_1 S^{be'}(x, 0)(\gamma_0 \Gamma_3 \gamma_0) \\
& \quad \times S^{e'b'}(0, 0)(\gamma_0 \Gamma_1 \gamma_0) D^{aa'T}(x, 0)] \text{Tr}[\Gamma_3 S^{ee}(x, x)] \\
& + \Gamma_2 U^{cc'}(x, 0)(\gamma_0 \Gamma_2 \gamma_0) \text{Tr}[\Gamma_1 S^{be'}(x, 0)(\gamma_0 \Gamma_3 \gamma_0) \\
& \quad \times S^{e'e}(0, x) \Gamma_3 S^{eb'}(x, 0)(\gamma_0 \Gamma_1 \gamma_0) D^{aa'T}(x, 0)] \\
& + \Gamma_2 U^{cc'}(x, 0)(\gamma_0 \Gamma_2 \gamma_0) \text{Tr}[\Gamma_1 S^{bb'}(x, 0)(\gamma_0 \Gamma_1 \gamma_0) \\
& \quad \times D^{aa'T}(x, 0)] \text{Tr}[\Gamma_3 S^{ee}(x, x)] \text{Tr}[(\gamma_0 \Gamma_3 \gamma_0) S^{e'e'}(0, 0)] \\
& - \Gamma_2 U^{cc'}(x, 0)(\gamma_0 \Gamma_2 \gamma_0) \text{Tr}[\Gamma_1 S^{bb'}(x, 0)(\gamma_0 \Gamma_1 \gamma_0) \\
& \quad \times D^{aa'T}(x, 0)] \text{Tr}[\Gamma_3 S^{ee'}(x, 0)(\gamma_0 \Gamma_3 \gamma_0) S^{e'e}(0, x)] \Big]
\end{aligned} \tag{F.3}$$

$$\begin{aligned}
\mathcal{G}_2^{\Lambda \text{can.}}(t, \vec{p}) &= \sum_{\vec{x}} e^{-i\vec{p}\cdot\vec{x}} \epsilon^{abc} \epsilon^{a'b'c'} \Big[ \\
& + S_s^{aa'}(x, 0) \text{Tr}[(C\gamma_5) S_u^{bb'}(x, 0)(C\gamma_5) \\
& \quad \times S_u^{e'c'T}(0, 0) \gamma_5 S_u^{ee'T}(x, 0) \gamma_5 S_u^{cc'T}(x, x)] \\
& - 2S_s^{aa'}(x, 0) \text{Tr}[(C\gamma_5) S_u^{bb'}(x, 0)(C\gamma_5) \\
& \quad \times S_u^{e'c'T}(x, 0) \gamma_5 S_u^{cc'T}(x, x)] \text{Tr}[\gamma_5 S_u^{e'e'}(0, 0)] \\
& - 2S_s^{aa'}(x, 0) \text{Tr}[(C\gamma_5) S_u^{bb'}(x, 0)(C\gamma_5) \\
& \quad \times S_u^{e'c'T}(0, 0) \gamma_5 S_u^{cc'T}(x, 0)] \text{Tr}[\gamma_5 S_u^{ee}(x, x)] \\
& + S_s^{aa'}(x, 0) \text{Tr}[(C\gamma_5) S_u^{bb'}(x, 0)(C\gamma_5) \\
& \quad \times S_u^{e'c'T}(x, 0) \gamma_5 S_u^{e'e'T}(0, x) \gamma_5 S_u^{cc'T}(x, 0)] \\
& + 4S_s^{aa'}(x, 0) \text{Tr}[(C\gamma_5) S_u^{bb'}(x, 0)(C\gamma_5) \\
& \quad \times S_u^{cc'T}(x, 0)] \text{Tr}[\gamma_5 S_u^{ee}(x, x)] \text{Tr}[\gamma_5 S_u^{e'e'}(0, 0)] \\
& - 2S_s^{aa'}(x, 0) \text{Tr}[(C\gamma_5) S_u^{bb'}(x, 0)(C\gamma_5) \\
& \quad \times S_u^{cc'T}(x, 0)] \text{Tr}[\gamma_5 S_u^{ee'}(x, 0) \gamma_5 S_u^{e'e}(0, x)] \\
& - 2S_s^{aa'}(x, 0)(C\gamma_5) S_u^{e'b'T}(0, 0) \gamma_5 S_u^{ee'T}(x, 0) \gamma_5 \\
& \quad \times S_u^{be'T}(x, x)(C\gamma_5) S_u^{cc'}(x, 0) \\
& + 4S_s^{aa'}(x, 0)(C\gamma_5) S_u^{eb'T}(x, 0) \gamma_5 S_u^{be'T}(x, x)(C\gamma_5) \\
& \quad \times S_u^{c'}(x, 0) \text{Tr}[\gamma_5 S_u^{e'e'}(0, 0)] \\
& + 4S_s^{aa'}(x, 0)(C\gamma_5) S_u^{e'b'T}(0, 0) \gamma_5 S_u^{be'T}(x, 0)(C\gamma_5)
\end{aligned}$$

$$\begin{aligned}
& \times S_u^{cc'}(x, 0) \text{Tr}[\gamma_5 S_u^{ee}(x, x)] \\
& - 2S_s^{aa'}(x, 0)(C\gamma_5)S_u^{eb'T}(x, 0)\gamma_5 S_u^{e'eT}(0, x)\gamma_5 \\
& \quad \times S_u^{be'T}(x, 0)(C\gamma_5)S_u^{cc'}(x, 0) \\
& - 8S_s^{aa'}(x, 0)(C\gamma_5)S_u^{bb'T}(x, 0)(C\gamma_5)S_u^{cc'}(x, 0) \\
& \quad \times \text{Tr}[\gamma_5 S_u^{ee}(x, x)] \text{Tr}[\gamma_5 S_u^{e'e'}(0, 0)] \\
& + 4S_s^{aa'}(x, 0)(C\gamma_5)S_u^{bb'T}(x, 0)(C\gamma_5)S_u^{cc'}(x, 0) \\
& \quad \times \text{Tr}[\gamma_5 S_u^{ee'}(x, 0)\gamma_5 S_u^{e'e}(0, x)] \\
& - 2S_s^{aa'}(x, 0)(C\gamma_5)S_u^{bb'T}(x, 0)(C\gamma_5)S_u^{ce}(x, x)\gamma_5 \\
& \quad \times S_u^{ee'}(x, 0)\gamma_5 S_u^{e'e'}(0, 0) \\
& + 4S_s^{aa'}(x, 0)(C\gamma_5)S_u^{bb'T}(x, 0)(C\gamma_5)S_u^{ce}(x, x)\gamma_5 \\
& \quad \times S_u^{e'e'}(x, 0) \text{Tr}[\gamma_5 S_u^{e'e'}(0, 0)] \\
& + 4S_s^{aa'}(x, 0)(C\gamma_5)S_u^{bb'T}(x, 0)(C\gamma_5)S_u^{ce'}(x, 0)\gamma_5 \\
& \quad \times S_u^{e'e'}(0, 0) \text{Tr}[\gamma_5 S_u^{ee}(x, x)] \\
& - 2S_s^{aa'}(x, 0)(C\gamma_5)S_u^{bb'T}(x, 0)(C\gamma_5)S_u^{ce'}(x, 0)\gamma_5 \\
& \quad \times S_u^{e'e}(0, x)\gamma_5 S_u^{ec'}(x, 0) \\
& + S_s^{aa'}(x, 0) \text{Tr}[(C\gamma_5)S_u^{be'}(x, 0)\gamma_5 \\
& \quad \times S_u^{e'b'}(0, 0)(C\gamma_5)S_u^{ec'T}(x, 0)\gamma_5 S_u^{ceT}(x, x)] \\
& - 2S_s^{aa'}(x, 0) \text{Tr}[(C\gamma_5)S_u^{be'}(x, 0)\gamma_5 \\
& \quad \times S_u^{e'b'}(0, 0)(C\gamma_5)S_u^{cc'T}(x, 0)] \text{Tr}[\gamma_5 S_u^{ee}(x, x)] \\
& - 2S_s^{aa'}(x, 0)(C\gamma_5)S_u^{eb'T}(x, 0)\gamma_5 S_u^{beT}(x, x)(C\gamma_5) \\
& \quad \times S_u^{ce'}(x, 0)\gamma_5 S_u^{e'e'}(0, 0) \\
& - 2S_s^{aa'}(x, 0)(C\gamma_5)S_u^{e'b'T}(0, 0)\gamma_5 S_u^{be'T}(x, 0)(C\gamma_5) \\
& \quad \times S_u^{ce}(x, x)\gamma_5 S_u^{e'e'}(x, 0) \\
& + S_s^{ae'}(x, 0)\gamma_5 S_s^{e'a'}(0, 0) \text{Tr}[(C\gamma_5) \\
& \quad \times S_u^{bb'}(x, 0)(C\gamma_5)S_u^{ec'T}(x, 0)\gamma_5 S_u^{ceT}(x, x)] \\
& - 2S_s^{ae'}(x, 0)\gamma_5 S_s^{e'a'}(0, 0) \text{Tr}[(C\gamma_5) \\
& \quad \times S_u^{bb'}(x, 0)(C\gamma_5)S_u^{cc'T}(x, 0)] \text{Tr}[\gamma_5 S_u^{ee}(x, x)] \\
& - S_s^{aa'}(x, 0) \text{Tr}[(C\gamma_5)S_u^{bb'}(x, 0)(C\gamma_5) \\
& \quad \times S_u^{ec'T}(x, 0)\gamma_5 S_u^{ceT}(x, x)] \text{Tr}[\gamma_5 S_s^{e'e'}(0, 0)] \\
& + 2S_s^{aa'}(x, 0) \text{Tr}[(C\gamma_5)S_u^{bb'}(x, 0)(C\gamma_5) \\
& \quad \times S_u^{cc'T}(x, 0)] \text{Tr}[\gamma_5 S_u^{ee}(x, x)] \text{Tr}[\gamma_5 S_s^{e'e'}(0, 0)]
\end{aligned}$$

$$\begin{aligned}
& - 2S_s^{ae'}(x, 0)\gamma_5 S_s^{e'a'}(0, 0)(C\gamma_5)S_u^{eb'T}(x, 0)\gamma_5 \\
& \quad \times S_u^{beT}(x, x)(C\gamma_5)S_u^{cc'}(x, 0) \\
& + 4S_s^{ae'}(x, 0)\gamma_5 S_s^{e'a'}(0, 0)(C\gamma_5)S_u^{bb'T}(x, 0)(C\gamma_5) \\
& \quad \times S_u^{cc'}(x, 0)\text{Tr}[\gamma_5 S_u^{ee}(x, x)] \\
& + 2S_s^{aa'}(x, 0)(C\gamma_5)S_u^{eb'T}(x, 0)\gamma_5 S_u^{beT}(x, x)(C\gamma_5) \\
& \quad \times S_u^{cc'}(x, 0)\text{Tr}[\gamma_5 S_s^{e'e'}(0, 0)] \\
& - 4S_s^{aa'}(x, 0)(C\gamma_5)S_u^{bb'T}(x, 0)(C\gamma_5)S_u^{cc'}(x, 0) \\
& \quad \times \text{Tr}[\gamma_5 S_u^{ee}(x, x)]\text{Tr}[\gamma_5 S_s^{e'e'}(0, 0)] \\
& - 2S_s^{ae'}(x, 0)\gamma_5 S_s^{e'a'}(0, 0)(C\gamma_5)S_u^{bb'T}(x, 0)(C\gamma_5) \\
& \quad \times S_u^{ce}(x, x)\gamma_5 S_u^{ec'}(x, 0) \\
& + 2S_s^{aa'}(x, 0)(C\gamma_5)S_u^{bb'T}(x, 0)(C\gamma_5)S_u^{ce}(x, x)\gamma_5 \\
& \quad \times S_u^{ec'}(x, 0)\text{Tr}[\gamma_5 S_s^{e'e'}(0, 0)] \\
& - 2S_u^{aa'}(x, 0)(C\gamma_5)S_u^{e'b'T}(0, 0)\gamma_5 S_u^{ee'T}(x, 0)\gamma_5 \\
& \quad \times S_u^{beT}(x, x)(C\gamma_5)S_s^{cc'}(x, 0) \\
& + 4S_u^{aa'}(x, 0)(C\gamma_5)S_u^{eb'T}(x, 0)\gamma_5 S_u^{beT}(x, x)(C\gamma_5) \\
& \quad \times S_s^{cc'}(x, 0)\text{Tr}[\gamma_5 S_u^{e'e'}(0, 0)] \\
& + 4S_u^{aa'}(x, 0)(C\gamma_5)S_u^{e'b'T}(0, 0)\gamma_5 S_u^{be'T}(x, 0)(C\gamma_5) \\
& \quad \times S_s^{cc'}(x, 0)\text{Tr}[\gamma_5 S_u^{ee}(x, x)] \\
& - 2S_u^{aa'}(x, 0)(C\gamma_5)S_u^{eb'T}(x, 0)\gamma_5 S_u^{e'eT}(0, x)\gamma_5 \\
& \quad \times S_u^{be'T}(x, 0)(C\gamma_5)S_s^{cc'}(x, 0) \\
& - 8S_u^{aa'}(x, 0)(C\gamma_5)S_u^{bb'T}(x, 0)(C\gamma_5)S_s^{cc'}(x, 0) \\
& \quad \times \text{Tr}[\gamma_5 S_u^{ee}(x, x)]\text{Tr}[\gamma_5 S_u^{e'e'}(0, 0)] \\
& + 4S_u^{aa'}(x, 0)(C\gamma_5)S_u^{bb'T}(x, 0)(C\gamma_5)S_s^{cc'}(x, 0) \\
& \quad \times \text{Tr}[\gamma_5 S_u^{ee'}(x, 0)\gamma_5 S_u^{e'e}(0, x)] \\
& + 2S_u^{aa'}(x, 0)\text{Tr}[(C\gamma_5)S_s^{bb'}(x, 0)(C\gamma_5) \\
& \quad \times S_u^{e'c'T}(0, 0)\gamma_5 S_u^{ee'T}(x, 0)\gamma_5 S_u^{ceT}(x, x)] \\
& - 4S_u^{aa'}(x, 0)\text{Tr}[(C\gamma_5)S_s^{bb'}(x, 0)(C\gamma_5) \\
& \quad \times S_u^{ec'T}(x, 0)\gamma_5 S_u^{ceT}(x, x)]\text{Tr}[\gamma_5 S_u^{e'e'}(0, 0)] \\
& - 4S_u^{aa'}(x, 0)\text{Tr}[(C\gamma_5)S_s^{bb'}(x, 0)(C\gamma_5) \\
& \quad \times S_u^{e'c'T}(0, 0)\gamma_5 S_u^{ce'T}(x, 0)]\text{Tr}[\gamma_5 S_u^{ee}(x, x)] \\
& + 2S_u^{aa'}(x, 0)\text{Tr}[(C\gamma_5)S_s^{bb'}(x, 0)(C\gamma_5)
\end{aligned}$$

$$\begin{aligned}
& \times S_u^{ec'T}(x, 0)\gamma_5 S_u^{e'e^T}(0, x)\gamma_5 S_u^{ce'T}(x, 0)] \\
& + 8S_u^{aa'}(x, 0)\text{Tr}[(C\gamma_5)S_s^{bb'}(x, 0)(C\gamma_5) \\
& \quad \times S_u^{cc'T}(x, 0)]\text{Tr}[\gamma_5 S_u^{ee}(x, x)]\text{Tr}[\gamma_5 S_u^{e'e'}(0, 0)] \\
& - 4S_u^{aa'}(x, 0)\text{Tr}[(C\gamma_5)S_s^{bb'}(x, 0)(C\gamma_5) \\
& \quad \times S_u^{cc'T}(x, 0)]\text{Tr}[\gamma_5 S_u^{ee'}(x, 0)\gamma_5 S_u^{e'e}(0, x)] \\
& - 2S_u^{aa'}(x, 0)(C\gamma_5)S_s^{bb'T}(x, 0)(C\gamma_5)S_u^{ce}(x, x)\gamma_5 \\
& \quad \times S_u^{e'e'}(x, 0)\gamma_5 S_u^{e'c'}(0, 0) \\
& + 4S_u^{aa'}(x, 0)(C\gamma_5)S_s^{bb'T}(x, 0)(C\gamma_5)S_u^{ce}(x, x)\gamma_5 \\
& \quad \times S_u^{e'c'}(x, 0)\text{Tr}[\gamma_5 S_u^{e'e'}(0, 0)] \\
& + 4S_u^{aa'}(x, 0)(C\gamma_5)S_s^{bb'T}(x, 0)(C\gamma_5)S_u^{ce'}(x, 0)\gamma_5 \\
& \quad \times S_u^{e'c'}(0, 0)\text{Tr}[\gamma_5 S_u^{ee}(x, x)] \\
& - 2S_u^{aa'}(x, 0)(C\gamma_5)S_s^{bb'T}(x, 0)(C\gamma_5)S_u^{ce'}(x, 0)\gamma_5 \\
& \quad \times S_u^{e'e}(0, x)\gamma_5 S_u^{ec'}(x, 0) \\
& - 8S_u^{aa'}(x, 0)(C\gamma_5)S_s^{bb'T}(x, 0)(C\gamma_5)S_u^{cc'}(x, 0) \\
& \quad \times \text{Tr}[\gamma_5 S_u^{ee}(x, x)]\text{Tr}[\gamma_5 S_u^{e'e'}(0, 0)] \\
& + 4S_u^{aa'}(x, 0)(C\gamma_5)S_s^{bb'T}(x, 0)(C\gamma_5)S_u^{cc'}(x, 0) \\
& \quad \times \text{Tr}[\gamma_5 S_u^{ee'}(x, 0)\gamma_5 S_u^{e'e}(0, x)] \\
& - 2S_u^{ae'}(x, 0)\gamma_5 S_u^{e'a'}(0, 0)(C\gamma_5)S_u^{eb'T}(x, 0)\gamma_5 \\
& \quad \times S_u^{be^T}(x, x)(C\gamma_5)S_s^{cc'}(x, 0) \\
& + 4S_u^{ae'}(x, 0)\gamma_5 S_u^{e'a'}(0, 0)(C\gamma_5)S_s^{bb'T}(x, 0)(C\gamma_5) \\
& \quad \times S_s^{cc'}(x, 0)\text{Tr}[\gamma_5 S_u^{ee}(x, x)] \\
& + 2S_u^{ae'}(x, 0)\gamma_5 S_u^{e'a'}(0, 0)\text{Tr}[(C\gamma_5) \\
& \quad \times S_s^{bb'}(x, 0)(C\gamma_5)S_u^{ec'T}(x, 0)\gamma_5 S_u^{ce^T}(x, x)] \\
& - 4S_u^{ae'}(x, 0)\gamma_5 S_u^{e'a'}(0, 0)\text{Tr}[(C\gamma_5) \\
& \quad \times S_s^{bb'}(x, 0)(C\gamma_5)S_u^{cc'T}(x, 0)]\text{Tr}[\gamma_5 S_u^{ee}(x, x)] \\
& - 2S_u^{ae'}(x, 0)\gamma_5 S_u^{e'a'}(0, 0)(C\gamma_5)S_s^{bb'T}(x, 0)(C\gamma_5) \\
& \quad \times S_u^{ce}(x, x)\gamma_5 S_u^{e'c'}(x, 0) \\
& + 4S_u^{ae'}(x, 0)\gamma_5 S_u^{e'a'}(0, 0)(C\gamma_5)S_s^{bb'T}(x, 0)(C\gamma_5) \\
& \quad \times S_u^{cc'}(x, 0)\text{Tr}[\gamma_5 S_u^{ee}(x, x)] \\
& - 2S_u^{aa'}(x, 0)(C\gamma_5)S_u^{eb'T}(x, 0)\gamma_5 S_u^{be^T}(x, x)(C\gamma_5) \\
& \quad \times S_s^{cc'}(x, 0)\gamma_5 S_s^{e'c'}(0, 0)
\end{aligned}$$

$$\begin{aligned}
& + 4S_u^{aa'}(x, 0)(C\gamma_5)S_u^{bb'T}(x, 0)(C\gamma_5)S_s^{ce'}(x, 0)\gamma_5 \\
& \quad \times S_s^{e'c'}(0, 0)\text{Tr}[\gamma_5 S_u^{ee}(x, x)] \\
& + 2S_u^{aa'}(x, 0)(C\gamma_5)S_u^{eb'T}(x, 0)\gamma_5 S_u^{be'T}(x, x)(C\gamma_5) \\
& \quad \times S_s^{cc'}(x, 0)\text{Tr}[\gamma_5 S_s^{e'e'}(0, 0)] \\
& - 4S_u^{aa'}(x, 0)(C\gamma_5)S_u^{bb'T}(x, 0)(C\gamma_5)S_s^{cc'}(x, 0) \\
& \quad \times \text{Tr}[\gamma_5 S_u^{ee}(x, x)]\text{Tr}[\gamma_5 S_s^{e'e'}(0, 0)] \\
& + 2S_u^{aa'}(x, 0)\text{Tr}[(C\gamma_5)S_s^{be'}(x, 0)\gamma_5 \\
& \quad \times S_s^{e'b'}(0, 0)(C\gamma_5)S_u^{ec'T}(x, 0)\gamma_5 S_u^{ce'T}(x, x)] \\
& - 4S_u^{aa'}(x, 0)\text{Tr}[(C\gamma_5)S_s^{be'}(x, 0)\gamma_5 \\
& \quad \times S_s^{e'b'}(0, 0)(C\gamma_5)S_u^{cc'T}(x, 0)]\text{Tr}[\gamma_5 S_u^{ee}(x, x)] \\
& - 2S_u^{aa'}(x, 0)\text{Tr}[(C\gamma_5)S_s^{bb'}(x, 0)(C\gamma_5) \\
& \quad \times S_u^{ec'T}(x, 0)\gamma_5 S_u^{ce'T}(x, x)]\text{Tr}[\gamma_5 S_s^{e'e'}(0, 0)] \\
& + 4S_u^{aa'}(x, 0)\text{Tr}[(C\gamma_5)S_s^{bb'}(x, 0)(C\gamma_5) \\
& \quad \times S_u^{cc'T}(x, 0)]\text{Tr}[\gamma_5 S_u^{ee}(x, x)]\text{Tr}[\gamma_5 S_s^{e'e'}(0, 0)] \\
& - 2S_u^{aa'}(x, 0)(C\gamma_5)S_s^{e'b'T}(0, 0)\gamma_5 S_s^{be'T}(x, 0)(C\gamma_5) \\
& \quad \times S_u^{ce}(x, x)\gamma_5 S_u^{ec'}(x, 0) \\
& + 4S_u^{aa'}(x, 0)(C\gamma_5)S_s^{e'b'T}(0, 0)\gamma_5 S_s^{be'T}(x, 0)(C\gamma_5) \\
& \quad \times S_u^{cc'}(x, 0)\text{Tr}[\gamma_5 S_u^{ee}(x, x)] \\
& + 2S_u^{aa'}(x, 0)(C\gamma_5)S_s^{bb'T}(x, 0)(C\gamma_5)S_u^{ce}(x, x)\gamma_5 \\
& \quad \times S_u^{ec'}(x, 0)\text{Tr}[\gamma_5 S_s^{e'e'}(0, 0)] \\
& - 4S_u^{aa'}(x, 0)(C\gamma_5)S_s^{bb'T}(x, 0)(C\gamma_5)S_u^{cc'}(x, 0) \\
& \quad \times \text{Tr}[\gamma_5 S_u^{ee}(x, x)]\text{Tr}[\gamma_5 S_s^{e'e'}(0, 0)] \\
& - 2S_u^{ae}(x, x)\gamma_5 S_u^{ee'}(x, 0)\gamma_5 S_u^{e'a'}(0, 0)(C\gamma_5) \\
& \quad \times S_u^{bb'T}(x, 0)(C\gamma_5)S_s^{cc'}(x, 0) \\
& + 4S_u^{ae}(x, x)\gamma_5 S_u^{ea'}(x, 0)(C\gamma_5)S_u^{bb'T}(x, 0)(C\gamma_5) \\
& \quad \times S_s^{cc'}(x, 0)\text{Tr}[\gamma_5 S_u^{e'e'}(0, 0)] \\
& - 2S_u^{ae'}(x, 0)\gamma_5 S_u^{e'e}(0, x)\gamma_5 S_u^{ea'}(x, 0)(C\gamma_5) \\
& \quad \times S_u^{bb'T}(x, 0)(C\gamma_5)S_s^{cc'}(x, 0) \\
& - 2S_u^{ae}(x, x)\gamma_5 S_u^{ee'}(x, 0)\gamma_5 S_u^{e'a'}(0, 0)(C\gamma_5) \\
& \quad \times S_s^{bb'T}(x, 0)(C\gamma_5)S_u^{cc'}(x, 0) \\
& + 4S_u^{ae}(x, x)\gamma_5 S_u^{ea'}(x, 0)(C\gamma_5)S_s^{bb'T}(x, 0)(C\gamma_5)
\end{aligned}$$

$$\begin{aligned}
& \times S_u^{cc'}(x, 0) \text{Tr}[\gamma_5 S_u^{e'e'}(0, 0)] \\
& - 2S_u^{ae'}(x, 0) \gamma_5 S_u^{e'e}(0, x) \gamma_5 S_u^{ea'}(x, 0) (C\gamma_5) \\
& \quad \times S_s^{bb'^T}(x, 0) (C\gamma_5) S_u^{cc'}(x, 0) \\
& + 2S_u^{ae}(x, x) \gamma_5 S_u^{ee'}(x, 0) \gamma_5 S_u^{e'a'}(0, 0) \\
& \quad \times \text{Tr}[(C\gamma_5) S_s^{bb'}(x, 0) (C\gamma_5) S_u^{cc'^T}(x, 0)] \\
& - 4S_u^{ae}(x, x) \gamma_5 S_u^{ea'}(x, 0) \text{Tr}[(C\gamma_5) \\
& \quad \times S_s^{bb'}(x, 0) (C\gamma_5) S_u^{cc'^T}(x, 0)] \text{Tr}[\gamma_5 S_u^{e'e'}(0, 0)] \\
& + 2S_u^{ae'}(x, 0) \gamma_5 S_u^{e'e}(0, x) \gamma_5 S_u^{ea'}(x, 0) \\
& \quad \times \text{Tr}[(C\gamma_5) S_s^{bb'}(x, 0) (C\gamma_5) S_u^{cc'^T}(x, 0)] \\
& - 2S_u^{ae}(x, x) \gamma_5 S_u^{ea'}(x, 0) (C\gamma_5) S_u^{e'b'^T}(0, 0) \gamma_5 \\
& \quad \times S_u^{be'^T}(x, 0) (C\gamma_5) S_s^{cc'}(x, 0) \\
& - 2S_u^{ae}(x, x) \gamma_5 S_u^{ea'}(x, 0) (C\gamma_5) S_s^{bb'^T}(x, 0) (C\gamma_5) \\
& \quad \times S_u^{ce'}(x, 0) \gamma_5 S_u^{e'c'}(0, 0) \\
& + 2S_u^{ae}(x, x) \gamma_5 S_u^{ea'}(x, 0) \text{Tr}[(C\gamma_5) \\
& \quad \times S_s^{bb'}(x, 0) (C\gamma_5) S_u^{e'c'^T}(0, 0) \gamma_5 S_u^{ce'^T}(x, 0)] \\
& - 2S_u^{ae}(x, x) \gamma_5 S_u^{ea'}(x, 0) (C\gamma_5) S_u^{bb'^T}(x, 0) (C\gamma_5) \\
& \quad \times S_s^{ce'}(x, 0) \gamma_5 S_s^{e'c'}(0, 0) \\
& + 2S_u^{ae}(x, x) \gamma_5 S_u^{ea'}(x, 0) (C\gamma_5) S_u^{bb'^T}(x, 0) (C\gamma_5) \\
& \quad \times S_s^{cc'}(x, 0) \text{Tr}[\gamma_5 S_s^{e'e'}(0, 0)] \\
& - 2S_u^{ae}(x, x) \gamma_5 S_u^{ea'}(x, 0) (C\gamma_5) S_s^{e'b'^T}(0, 0) \gamma_5 \\
& \quad \times S_s^{be'^T}(x, 0) (C\gamma_5) S_u^{cc'}(x, 0) \\
& + 2S_u^{ae}(x, x) \gamma_5 S_u^{ea'}(x, 0) (C\gamma_5) S_s^{bb'^T}(x, 0) (C\gamma_5) \\
& \quad \times S_u^{cc'}(x, 0) \text{Tr}[\gamma_5 S_s^{e'e'}(0, 0)] \\
& + 2S_u^{ae}(x, x) \gamma_5 S_u^{ea'}(x, 0) \text{Tr}[(C\gamma_5) \\
& \quad \times S_s^{be'}(x, 0) \gamma_5 S_s^{e'b'}(0, 0) (C\gamma_5) S_u^{cc'^T}(x, 0)] \\
& - 2S_u^{ae}(x, x) \gamma_5 S_u^{ea'}(x, 0) \text{Tr}[(C\gamma_5) \\
& \quad \times S_s^{bb'}(x, 0) (C\gamma_5) S_u^{cc'^T}(x, 0)] \text{Tr}[\gamma_5 S_s^{e'e'}(0, 0)] \\
& + S_s^{aa'}(x, 0) \text{Tr}[(C\gamma_5) S_u^{be}(x, x) \gamma_5 \\
& \quad \times S_u^{eb'}(x, 0) (C\gamma_5) S_u^{e'c'^T}(0, 0) \gamma_5 S_u^{ce'^T}(x, 0)] \\
& - 2S_s^{aa'}(x, 0) \text{Tr}[(C\gamma_5) S_u^{be}(x, x) \gamma_5 \\
& \quad \times S_u^{eb'}(x, 0) (C\gamma_5) S_u^{cc'^T}(x, 0)] \text{Tr}[\gamma_5 S_u^{e'e'}(0, 0)]
\end{aligned}$$

$$\begin{aligned}
& + S_s^{aa'}(x, 0) \text{Tr}[(C\gamma_5)S_u^{be}(x, x)\gamma_5 \\
& \quad \times S_u^{e'e'}(x, 0)\gamma_5 S_u^{e'b'}(0, 0)(C\gamma_5)S_u^{cc'T}(x, 0)] \\
& + S_s^{aa'}(x, 0) \text{Tr}[(C\gamma_5)S_u^{be'}(x, 0)\gamma_5 \\
& \quad \times S_u^{e'e}(0, x)\gamma_5 S_u^{eb'}(x, 0)(C\gamma_5)S_u^{cc'T}(x, 0)] \\
& + S_s^{ae'}(x, 0)\gamma_5 S_s^{e'a'}(0, 0) \text{Tr}[(C\gamma_5) \\
& \quad \times S_u^{be}(x, x)\gamma_5 S_u^{eb'}(x, 0)(C\gamma_5)S_u^{cc'T}(x, 0)] \\
& - S_s^{aa'}(x, 0) \text{Tr}[(C\gamma_5)S_u^{be}(x, x)\gamma_5 \\
& \quad \times S_u^{eb'}(x, 0)(C\gamma_5)S_u^{cc'T}(x, 0)] \text{Tr}[\gamma_5 S_s^{e'e'}(0, 0)] \\
& + S_s^{ae}(x, x)\gamma_5 S_s^{ea'}(x, 0) \text{Tr}[(C\gamma_5) \\
& \quad \times S_u^{bb'}(x, 0)(C\gamma_5)S_u^{e'c'T}(0, 0)\gamma_5 S_u^{ce'T}(x, 0)] \\
& - 2S_s^{ae}(x, x)\gamma_5 S_s^{ea'}(x, 0) \text{Tr}[(C\gamma_5) \\
& \quad \times S_u^{bb'}(x, 0)(C\gamma_5)S_u^{cc'T}(x, 0)] \text{Tr}[\gamma_5 S_u^{e'e'}(0, 0)] \\
& - S_s^{aa'}(x, 0) \text{Tr}[(C\gamma_5)S_u^{bb'}(x, 0)(C\gamma_5) \\
& \quad \times S_u^{e'c'T}(0, 0)\gamma_5 S_u^{ce'T}(x, 0)] \text{Tr}[\gamma_5 S_s^{ee}(x, x)] \\
& + 2S_s^{aa'}(x, 0) \text{Tr}[(C\gamma_5)S_u^{bb'}(x, 0)(C\gamma_5) \\
& \quad \times S_u^{cc'T}(x, 0)] \text{Tr}[\gamma_5 S_s^{ee}(x, x)] \text{Tr}[\gamma_5 S_u^{e'e'}(0, 0)] \\
& - 2S_s^{ae}(x, x)\gamma_5 S_s^{ea'}(x, 0)(C\gamma_5)S_u^{e'b'T}(0, 0)\gamma_5 \\
& \quad \times S_u^{be'T}(x, 0)(C\gamma_5)S_u^{cc'}(x, 0) \\
& + 4S_s^{ae}(x, x)\gamma_5 S_s^{ea'}(x, 0)(C\gamma_5)S_u^{bb'T}(x, 0)(C\gamma_5) \\
& \quad \times S_u^{cc'}(x, 0) \text{Tr}[\gamma_5 S_u^{e'e'}(0, 0)] \\
& + 2S_s^{aa'}(x, 0)(C\gamma_5)S_u^{e'b'T}(0, 0)\gamma_5 S_u^{be'T}(x, 0)(C\gamma_5) \\
& \quad \times S_u^{cc'}(x, 0) \text{Tr}[\gamma_5 S_s^{ee}(x, x)] \\
& - 4S_s^{aa'}(x, 0)(C\gamma_5)S_u^{bb'T}(x, 0)(C\gamma_5)S_u^{cc'}(x, 0) \\
& \quad \times \text{Tr}[\gamma_5 S_s^{ee}(x, x)] \text{Tr}[\gamma_5 S_u^{e'e'}(0, 0)] \\
& - 2S_s^{ae}(x, x)\gamma_5 S_s^{ea'}(x, 0)(C\gamma_5)S_u^{bb'T}(x, 0)(C\gamma_5) \\
& \quad \times S_u^{ce'}(x, 0)\gamma_5 S_u^{e'c'}(0, 0) \\
& + 2S_s^{aa'}(x, 0)(C\gamma_5)S_u^{bb'T}(x, 0)(C\gamma_5)S_u^{ce'}(x, 0)\gamma_5 \\
& \quad \times S_u^{e'c'}(0, 0) \text{Tr}[\gamma_5 S_s^{ee}(x, x)] \\
& + S_s^{ae}(x, x)\gamma_5 S_s^{ea'}(x, 0) \text{Tr}[(C\gamma_5) \\
& \quad \times S_u^{be'}(x, 0)\gamma_5 S_u^{e'b'}(0, 0)(C\gamma_5)S_u^{cc'T}(x, 0)] \\
& - S_s^{aa'}(x, 0) \text{Tr}[(C\gamma_5)S_u^{be'}(x, 0)\gamma_5
\end{aligned}$$

$$\begin{aligned}
& \times S_u^{e'b'}(0,0)(C\gamma_5)S_u^{cc'T}(x,0)] \text{Tr}[\gamma_5 S_s^{ee}(x,x)] \\
+ & S_s^{ae}(x,x)\gamma_5 S_s^{ee'}(x,0)\gamma_5 S_s^{e'a'}(0,0) \\
& \times \text{Tr}[(C\gamma_5)S_u^{bb'}(x,0)(C\gamma_5)S_u^{cc'T}(x,0)] \\
- & S_s^{ae}(x,x)\gamma_5 S_s^{ea'}(x,0)\text{Tr}[(C\gamma_5) \\
& \times S_u^{bb'}(x,0)(C\gamma_5)S_u^{cc'T}(x,0)] \text{Tr}[\gamma_5 S_s^{e'e'}(0,0)] \\
- & S_s^{ae'}(x,0)\gamma_5 S_s^{e'a'}(0,0)\text{Tr}[(C\gamma_5) \\
& \times S_u^{bb'}(x,0)(C\gamma_5)S_u^{cc'T}(x,0)] \text{Tr}[\gamma_5 S_s^{ee}(x,x)] \\
+ & S_s^{ae'}(x,0)\gamma_5 S_s^{e'e}(0,x)\gamma_5 S_s^{ea'}(x,0) \\
& \times \text{Tr}[(C\gamma_5)S_u^{bb'}(x,0)(C\gamma_5)S_u^{cc'T}(x,0)] \\
+ & S_s^{aa'}(x,0)\text{Tr}[(C\gamma_5)S_u^{bb'}(x,0)(C\gamma_5) \\
& \times S_u^{cc'T}(x,0)] \text{Tr}[\gamma_5 S_s^{ee}(x,x)] \text{Tr}[\gamma_5 S_s^{e'e'}(0,0)] \\
- & S_s^{aa'}(x,0)\text{Tr}[(C\gamma_5)S_u^{bb'}(x,0)(C\gamma_5) \\
& \times S_u^{cc'T}(x,0)] \text{Tr}[\gamma_5 S_s^{ee'}(x,0)\gamma_5 S_s^{e'e}(0,x)] \\
- & 2S_s^{ae}(x,x)\gamma_5 S_s^{ee'}(x,0)\gamma_5 S_s^{e'a'}(0,0)(C\gamma_5) \\
& \times S_u^{bb'T}(x,0)(C\gamma_5)S_u^{cc'}(x,0) \\
+ & 2S_s^{ae}(x,x)\gamma_5 S_s^{ea'}(x,0)(C\gamma_5)S_u^{bb'T}(x,0)(C\gamma_5) \\
& \times S_u^{cc'}(x,0)\text{Tr}[\gamma_5 S_s^{e'e'}(0,0)] \\
+ & 2S_s^{ae'}(x,0)\gamma_5 S_s^{e'a'}(0,0)(C\gamma_5)S_u^{bb'T}(x,0)(C\gamma_5) \\
& \times S_u^{cc'}(x,0)\text{Tr}[\gamma_5 S_s^{ee}(x,x)] \\
- & 2S_s^{ae'}(x,0)\gamma_5 S_s^{e'e}(0,x)\gamma_5 S_s^{ea'}(x,0)(C\gamma_5) \\
& \times S_u^{bb'T}(x,0)(C\gamma_5)S_u^{cc'}(x,0) \\
- & 2S_s^{aa'}(x,0)(C\gamma_5)S_u^{bb'T}(x,0)(C\gamma_5)S_u^{cc'}(x,0) \\
& \times \text{Tr}[\gamma_5 S_s^{ee}(x,x)] \text{Tr}[\gamma_5 S_s^{e'e'}(0,0)] \\
+ & 2S_s^{aa'}(x,0)(C\gamma_5)S_u^{bb'T}(x,0)(C\gamma_5)S_u^{cc'}(x,0) \\
& \times \text{Tr}[\gamma_5 S_s^{ee'}(x,0)\gamma_5 S_s^{e'e}(0,x)] \\
- & 2S_u^{aa'}(x,0)(C\gamma_5)S_u^{e'b'T}(0,0)\gamma_5 S_u^{be'T}(x,0)(C\gamma_5) \\
& \times S_s^{ce}(x,x)\gamma_5 S_s^{e'c'}(x,0) \\
+ & 4S_u^{aa'}(x,0)(C\gamma_5)S_u^{bb'T}(x,0)(C\gamma_5)S_s^{ce}(x,x)\gamma_5 \\
& \times S_s^{e'c'}(x,0)\text{Tr}[\gamma_5 S_u^{e'e'}(0,0)] \\
+ & 2S_u^{aa'}(x,0)(C\gamma_5)S_u^{e'b'T}(0,0)\gamma_5 S_u^{be'T}(x,0)(C\gamma_5) \\
& \times S_s^{cc'}(x,0)\text{Tr}[\gamma_5 S_s^{ee}(x,x)]
\end{aligned}$$



$$\begin{aligned}
& -4S_u^{aa'}(x, 0)(C\gamma_5)S_u^{bb'T}(x, 0)(C\gamma_5)S_s^{cc'}(x, 0) \\
& \quad \times \text{Tr}[\gamma_5 S_s^{ee}(x, x)] \text{Tr}[\gamma_5 S_u^{e'e'}(0, 0)] \\
& + 2S_u^{aa'}(x, 0) \text{Tr}[(C\gamma_5)S_s^{be}(x, x)\gamma_5 \\
& \quad \times S_s^{eb'}(x, 0)(C\gamma_5)S_u^{e'e'T}(0, 0)\gamma_5 S_u^{ce'T}(x, 0)] \\
& - 4S_u^{aa'}(x, 0) \text{Tr}[(C\gamma_5)S_s^{be}(x, x)\gamma_5 \\
& \quad \times S_s^{eb'}(x, 0)(C\gamma_5)S_u^{cc'T}(x, 0)] \text{Tr}[\gamma_5 S_u^{e'e'}(0, 0)] \\
& - 2S_u^{aa'}(x, 0) \text{Tr}[(C\gamma_5)S_s^{bb'}(x, 0)(C\gamma_5) \\
& \quad \times S_u^{e'e'T}(0, 0)\gamma_5 S_u^{ce'T}(x, 0)] \text{Tr}[\gamma_5 S_s^{ee}(x, x)] \\
& + 4S_u^{aa'}(x, 0) \text{Tr}[(C\gamma_5)S_s^{bb'}(x, 0)(C\gamma_5) \\
& \quad \times S_u^{cc'T}(x, 0)] \text{Tr}[\gamma_5 S_s^{ee}(x, x)] \text{Tr}[\gamma_5 S_u^{e'e'}(0, 0)] \\
& - 2S_u^{aa'}(x, 0)(C\gamma_5)S_s^{eb'T}(x, 0)\gamma_5 S_s^{be'T}(x, x)(C\gamma_5) \\
& \quad \times S_u^{ce'}(x, 0)\gamma_5 S_u^{e'e'}(0, 0) \\
& + 4S_u^{aa'}(x, 0)(C\gamma_5)S_s^{eb'T}(x, 0)\gamma_5 S_s^{be'T}(x, x)(C\gamma_5) \\
& \quad \times S_u^{ce'}(x, 0) \text{Tr}[\gamma_5 S_u^{e'e'}(0, 0)] \\
& + 2S_u^{aa'}(x, 0)(C\gamma_5)S_s^{bb'T}(x, 0)(C\gamma_5)S_u^{ce'}(x, 0)\gamma_5 \\
& \quad \times S_u^{e'e'}(0, 0) \text{Tr}[\gamma_5 S_s^{ee}(x, x)] \\
& - 4S_u^{aa'}(x, 0)(C\gamma_5)S_s^{bb'T}(x, 0)(C\gamma_5)S_u^{cc'}(x, 0) \\
& \quad \times \text{Tr}[\gamma_5 S_s^{ee}(x, x)] \text{Tr}[\gamma_5 S_u^{e'e'}(0, 0)] \\
& - 2S_u^{ae'}(x, 0)\gamma_5 S_u^{e'a'}(0, 0)(C\gamma_5)S_u^{bb'T}(x, 0)(C\gamma_5) \\
& \quad \times S_s^{ce}(x, x)\gamma_5 S_s^{ce'}(x, 0) \\
& + 2S_u^{ae'}(x, 0)\gamma_5 S_u^{e'a'}(0, 0)(C\gamma_5)S_u^{bb'T}(x, 0)(C\gamma_5) \\
& \quad \times S_s^{ce'}(x, 0) \text{Tr}[\gamma_5 S_s^{ee}(x, x)] \\
& + 2S_u^{ae'}(x, 0)\gamma_5 S_u^{e'a'}(0, 0) \text{Tr}[(C\gamma_5) \\
& \quad \times S_s^{be}(x, x)\gamma_5 S_s^{eb'}(x, 0)(C\gamma_5)S_u^{cc'T}(x, 0)] \\
& - 2S_u^{ae'}(x, 0)\gamma_5 S_u^{e'a'}(0, 0) \text{Tr}[(C\gamma_5) \\
& \quad \times S_s^{bb'}(x, 0)(C\gamma_5)S_u^{cc'T}(x, 0)] \text{Tr}[\gamma_5 S_s^{ee}(x, x)] \\
& - 2S_u^{ae'}(x, 0)\gamma_5 S_u^{e'a'}(0, 0)(C\gamma_5)S_s^{eb'T}(x, 0)\gamma_5 \\
& \quad \times S_s^{be'T}(x, x)(C\gamma_5)S_u^{ce'}(x, 0) \\
& + 2S_u^{ae'}(x, 0)\gamma_5 S_u^{e'a'}(0, 0)(C\gamma_5)S_s^{bb'T}(x, 0)(C\gamma_5) \\
& \quad \times S_u^{ce'}(x, 0) \text{Tr}[\gamma_5 S_s^{ee}(x, x)] \\
& - 2S_u^{aa'}(x, 0)(C\gamma_5)S_u^{bb'T}(x, 0)(C\gamma_5)S_s^{ce}(x, x)\gamma_5
\end{aligned}$$

$$\begin{aligned}
& \times S_s^{ee'}(x, 0)\gamma_5 S_s^{e'c'}(0, 0) \\
+ 2S_u^{aa'}(x, 0)(C\gamma_5)S_u^{bb'T}(x, 0)(C\gamma_5)S_s^{ce}(x, x)\gamma_5 \\
& \times S_s^{e'c'}(x, 0)\text{Tr}[\gamma_5 S_s^{e'e'}(0, 0)] \\
+ 2S_u^{aa'}(x, 0)(C\gamma_5)S_u^{bb'T}(x, 0)(C\gamma_5)S_s^{ce'}(x, 0)\gamma_5 \\
& \times S_s^{e'c'}(0, 0)\text{Tr}[\gamma_5 S_s^{ee}(x, x)] \\
- 2S_u^{aa'}(x, 0)(C\gamma_5)S_u^{bb'T}(x, 0)(C\gamma_5)S_s^{ce'}(x, 0)\gamma_5 \\
& \times S_s^{e'e}(0, x)\gamma_5 S_s^{ec'}(x, 0) \\
- 2S_u^{aa'}(x, 0)(C\gamma_5)S_u^{bb'T}(x, 0)(C\gamma_5)S_s^{cc'}(x, 0) \\
& \times \text{Tr}[\gamma_5 S_s^{ee}(x, x)]\text{Tr}[\gamma_5 S_s^{e'e'}(0, 0)] \\
+ 2S_u^{aa'}(x, 0)(C\gamma_5)S_u^{bb'T}(x, 0)(C\gamma_5)S_s^{cc'}(x, 0) \\
& \times \text{Tr}[\gamma_5 S_s^{ee'}(x, 0)\gamma_5 S_s^{e'e}(0, x)] \\
+ 2S_u^{aa'}(x, 0)\text{Tr}[(C\gamma_5)S_s^{be}(x, x)\gamma_5 \\
& \times S_s^{e'e'}(x, 0)\gamma_5 S_s^{e'b'}(0, 0)(C\gamma_5)S_u^{cc'T}(x, 0)] \\
- 2S_u^{aa'}(x, 0)\text{Tr}[(C\gamma_5)S_s^{be}(x, x)\gamma_5 \\
& \times S_s^{e'b'}(x, 0)(C\gamma_5)S_u^{cc'T}(x, 0)]\text{Tr}[\gamma_5 S_s^{e'e'}(0, 0)] \\
- 2S_u^{aa'}(x, 0)\text{Tr}[(C\gamma_5)S_s^{be'}(x, 0)\gamma_5 \\
& \times S_s^{e'b'}(0, 0)(C\gamma_5)S_u^{cc'T}(x, 0)]\text{Tr}[\gamma_5 S_s^{ee}(x, x)] \\
+ 2S_u^{aa'}(x, 0)\text{Tr}[(C\gamma_5)S_s^{be'}(x, 0)\gamma_5 \\
& \times S_s^{e'e}(0, x)\gamma_5 S_s^{b'e'}(x, 0)(C\gamma_5)S_u^{cc'T}(x, 0)] \\
+ 2S_u^{aa'}(x, 0)\text{Tr}[(C\gamma_5)S_s^{bb'}(x, 0)(C\gamma_5) \\
& \times S_u^{cc'T}(x, 0)]\text{Tr}[\gamma_5 S_s^{ee}(x, x)]\text{Tr}[\gamma_5 S_s^{e'e'}(0, 0)] \\
- 2S_u^{aa'}(x, 0)\text{Tr}[(C\gamma_5)S_s^{bb'}(x, 0)(C\gamma_5) \\
& \times S_u^{cc'T}(x, 0)]\text{Tr}[\gamma_5 S_s^{ee'}(x, 0)\gamma_5 S_s^{e'e}(0, x)] \\
- 2S_u^{aa'}(x, 0)(C\gamma_5)S_s^{e'b'T}(0, 0)\gamma_5 S_s^{ee'T}(x, 0)\gamma_5 \\
& \times S_s^{beT}(x, x)(C\gamma_5)S_u^{cc'}(x, 0) \\
+ 2S_u^{aa'}(x, 0)(C\gamma_5)S_s^{eb'T}(x, 0)\gamma_5 S_s^{beT}(x, x)(C\gamma_5) \\
& \times S_u^{cc'}(x, 0)\text{Tr}[\gamma_5 S_s^{e'e'}(0, 0)] \\
+ 2S_u^{aa'}(x, 0)(C\gamma_5)S_s^{e'b'T}(0, 0)\gamma_5 S_s^{be'T}(x, 0)(C\gamma_5) \\
& \times S_u^{cc'}(x, 0)\text{Tr}[\gamma_5 S_s^{ee}(x, x)] \\
- 2S_u^{aa'}(x, 0)(C\gamma_5)S_s^{eb'T}(x, 0)\gamma_5 S_s^{e'eT}(0, x)\gamma_5 \\
& \times S_s^{be'T}(x, 0)(C\gamma_5)S_u^{cc'}(x, 0)
\end{aligned}$$

$$\begin{aligned}
& - 2S_u^{aa'}(x, 0)(C\gamma_5)S_s^{bb'T}(x, 0)(C\gamma_5)S_u^{cc'}(x, 0) \\
& \quad \times \text{Tr}[\gamma_5 S_s^{ee}(x, x)] \text{Tr}[\gamma_5 S_s^{e'e'}(0, 0)] \\
& + 2S_u^{aa'}(x, 0)(C\gamma_5)S_s^{bb'T}(x, 0)(C\gamma_5)S_u^{cc'}(x, 0) \\
& \quad \times \text{Tr}[\gamma_5 S_s^{ee'}(x, 0)\gamma_5 S_s^{e'e}(0, x)] \Big] \tag{F.4}
\end{aligned}$$

### F.3 Two-Particle $\Delta^{++}$ Correlation Function

$$\begin{aligned}
\mathcal{G}_2^{\Delta^{++}}(t, \vec{p}) = \sum_{\vec{x}} e^{-i\vec{p}\cdot\vec{x}} \epsilon^{abc} \epsilon^{a'b'c'} \Big[ & \\
& + \Gamma_2 U^{cc'}(x, 0)(\gamma_0 \Gamma_2^\dagger \gamma_0) \text{Tr}[\Gamma_1 D^{be}(x, x) \Gamma_3 \\
& \quad \times U^{ea'}(x, 0)(\gamma_0 \Gamma_1^\dagger \gamma_0)^T D^{e'b'T}(0, 0)(\gamma_0 \Gamma_3^\dagger \gamma_0)^T U^{ae'T}(x, 0)] \\
& - \Gamma_2 U^{ca'}(x, 0)(\gamma_0 \Gamma_1^\dagger \gamma_0)^T D^{e'b'T}(0, 0)(\gamma_0 \Gamma_3^\dagger \gamma_0)^T U^{ae'T}(x, 0) \Gamma_1 \\
& \quad \times D^{be}(x, x) \Gamma_3 U^{ec'}(x, 0)(\gamma_0 \Gamma_2^\dagger \gamma_0) \\
& - \Gamma_2 U^{ce'}(x, 0)(\gamma_0 \Gamma_3^\dagger \gamma_0) D^{e'b'}(0, 0)(\gamma_0 \Gamma_1^\dagger \gamma_0) U^{ea'T}(x, 0) \Gamma_3^T \\
& \quad \times D^{beT}(x, x) \Gamma_1^T U^{ac'}(x, 0)(\gamma_0 \Gamma_2^\dagger \gamma_0) \\
& + \Gamma_2 U^{ca'}(x, 0)(\gamma_0 \Gamma_1^\dagger \gamma_0)^T D^{e'b'T}(0, 0)(\gamma_0 \Gamma_3^\dagger \gamma_0)^T U^{ee'T}(x, 0) \Gamma_3^T \\
& \quad \times D^{beT}(x, x) \Gamma_1^T U^{ac'}(x, 0)(\gamma_0 \Gamma_2^\dagger \gamma_0) \\
& + \Gamma_2 U^{ce'}(x, 0)(\gamma_0 \Gamma_3^\dagger \gamma_0) D^{e'b'}(0, 0)(\gamma_0 \Gamma_1^\dagger \gamma_0) U^{aa'T}(x, 0) \Gamma_1 \\
& \quad \times D^{be}(x, x) \Gamma_3 U^{ec'}(x, 0)(\gamma_0 \Gamma_2^\dagger \gamma_0) \\
& - \Gamma_2 U^{cc'}(x, 0)(\gamma_0 \Gamma_2^\dagger \gamma_0) \text{Tr}[\Gamma_1 D^{be}(x, x) \Gamma_3 \\
& \quad \times U^{ee'}(x, 0)(\gamma_0 \Gamma_3^\dagger \gamma_0) D^{e'b'}(0, 0)(\gamma_0 \Gamma_1^\dagger \gamma_0) U^{aa'T}(x, 0)] \\
& - \Gamma_2 U^{cc'}(x, 0)(\gamma_0 \Gamma_2^\dagger \gamma_0) \text{Tr}[\Gamma_1 D^{bb'}(x, 0)(\gamma_0 \Gamma_1^\dagger \gamma_0) \\
& \quad \times U^{ea'T}(x, 0) \Gamma_3^T D^{e'eT}(0, x)(\gamma_0 \Gamma_3^\dagger \gamma_0)^T U^{ae'T}(x, 0)] \\
& + \Gamma_2 U^{ca'}(x, 0)(\gamma_0 \Gamma_1^\dagger \gamma_0)^T D^{bb'T}(x, 0) \Gamma_1^T U^{ae'}(x, 0)(\gamma_0 \Gamma_3^\dagger \gamma_0) \\
& \quad \times D^{e'e}(0, x) \Gamma_3 U^{ec'}(x, 0)(\gamma_0 \Gamma_2^\dagger \gamma_0) \\
& + \Gamma_2 U^{ce'}(x, 0)(\gamma_0 \Gamma_3^\dagger \gamma_0) D^{e'e}(0, x) \Gamma_3 U^{ea'}(x, 0)(\gamma_0 \Gamma_1^\dagger \gamma_0)^T \\
& \quad \times D^{bb'T}(x, 0) \Gamma_1^T U^{ac'}(x, 0)(\gamma_0 \Gamma_2^\dagger \gamma_0) \\
& - \Gamma_2 U^{ca'}(x, 0)(\gamma_0 \Gamma_1^\dagger \gamma_0)^T D^{bb'T}(x, 0) \Gamma_1^T U^{ac'}(x, 0)(\gamma_0 \Gamma_2^\dagger \gamma_0) \\
& \quad \times \text{Tr}[\Gamma_3 U^{ee'}(x, 0)(\gamma_0 \Gamma_3^\dagger \gamma_0) D^{e'e}(0, x)] \\
& - \Gamma_2 U^{ce'}(x, 0)(\gamma_0 \Gamma_3^\dagger \gamma_0) D^{e'e}(0, x) \Gamma_3 U^{ec'}(x, 0)(\gamma_0 \Gamma_2^\dagger \gamma_0) \\
& \quad \times \text{Tr}[\Gamma_1 D^{bb'}(x, 0)(\gamma_0 \Gamma_1^\dagger \gamma_0) U^{aa'T}(x, 0)] \\
& + \Gamma_2 U^{cc'}(x, 0)(\gamma_0 \Gamma_2^\dagger \gamma_0) \text{Tr}[\Gamma_1 D^{bb'}(x, 0)(\gamma_0 \Gamma_1^\dagger \gamma_0)
\end{aligned}$$

$$\times U^{aa'T}(x, 0)] \text{Tr} \left[ \Gamma_3 U^{ee'}(x, 0) (\gamma_0 \Gamma_3^\dagger \gamma_0) D^{e'e}(0, x) \right] \quad (\text{F.5})$$

## F.4 Equivalence of Correlation Functions

In this section we briefly demonstrate that some of the correlation functions corresponding to the interpolators outlined in table 3.1 are identical at the  $SU(3)$  flavour limit (or simply after imposing isospin symmetry where no strange quarks are present). We begin with the simple case of demonstrating the equivalence of  $\langle 0 | \chi_{\pi^0}(x) \chi_{\pi^0}^\dagger(0) | 0 \rangle$  and  $\langle 0 | \chi_{\pi^+}(x) \chi_{\pi^+}^\dagger(0) | 0 \rangle$ . Starting with  $\pi^+$  we see

$$\chi_{\pi^+}(x) = \bar{d}^e(x) \gamma_5 u^e(x) \quad \rightarrow \quad \chi_{\pi^+}^\dagger(x) = -\bar{u}^{e'}(x) \gamma_5 d^{e'}(x), \quad (\text{F.6})$$

and therefore

$$\begin{aligned} \chi_{\pi^+}(x) \chi_{\pi^+}^\dagger(0) &= -\bar{d}_\alpha^e(x) (\gamma_5)_{\alpha\beta} u_\beta^e(x) \bar{u}_{\beta'}^{e'}(0) (\gamma_5)_{\beta'\alpha'} d_{\alpha'}^{e'}(0) \\ &= d_{\alpha'}^{e'}(0) \bar{d}_\alpha^e(x) u_\beta^e(x) \bar{u}_{\beta'}^{e'}(0) (\gamma_5)_{\alpha\beta} (\gamma_5)_{\beta'\alpha'}. \end{aligned} \quad (\text{F.7})$$

Now taking all possible contractions as ameliorated in appendix D we obtain

$$\begin{aligned} \langle 0 | \chi_{\pi^+}(x) \chi_{\pi^+}^\dagger(0) | 0 \rangle &= D_{\alpha'\alpha}^{e'e}(0, x) U_{\beta\beta'}^{ee'}(\gamma_5)_{\alpha\beta} (\gamma_5)_{\beta'\alpha'} \\ &= D_{\alpha'\alpha}^{e'e}(0, x) (\gamma_5)_{\alpha\beta} U_{\beta\beta'}^{ee'}(\gamma_5)_{\beta'\alpha'} \\ &= \text{Tr} [S^{e'e}(0, x) (\gamma_5) S^{e'e}(x, 0) (\gamma_5)], \end{aligned} \quad (\text{F.8})$$

where we have imposed isospin symmetry on the final line, denoting the propagator  $S$ . Similarly, using

$$\begin{aligned} \chi_{\pi^0}(x) &= \frac{1}{\sqrt{2}} (\bar{d}^e(x) \gamma_5 d^e(x) - \bar{u}^e(x) \gamma_5 u^e(x)) \\ \chi_{\pi^0}^\dagger(x) &= \frac{1}{\sqrt{2}} (\bar{u}^e(x) \gamma_5 u^e(x) - \bar{d}^e(x) \gamma_5 d^e(x)) \end{aligned} \quad (\text{F.9})$$

we obtain

$$\begin{aligned} \chi_{\pi^0}(x) \chi_{\pi^0}^\dagger(0) &= \frac{1}{2} \left[ (\bar{d}_\alpha^e(x) (\gamma_5)_{\alpha\beta} d_\beta^e(x) - \bar{u}_\alpha^e(x) (\gamma_5)_{\alpha\beta} u_\beta^e(x)) \right. \\ &\quad \left. \times (\bar{u}_{\beta'}^{e'}(0) (\gamma_5)_{\beta'\alpha'} u_{\alpha'}^{e'}(0) - \bar{d}_{\beta'}^{e'}(0) (\gamma_5)_{\beta'\alpha'} d_{\alpha'}^{e'}(0)) \right] \\ &= \frac{1}{2} \left[ d_\beta^e(x) \bar{d}_\alpha^e(x) u_{\alpha'}^{e'}(0) \bar{u}_{\beta'}^{e'}(0) - d_\beta^e(x) \bar{d}_\alpha^e(x) d_{\alpha'}^{e'}(0) \bar{d}_{\beta'}^{e'}(0) \right. \\ &\quad \left. - u_\beta^e(x) \bar{u}_\alpha^e(x) u_{\alpha'}^{e'}(0) \bar{u}_{\beta'}^{e'}(0) + u_\beta^e(x) \bar{u}_\alpha^e(x) d_{\alpha'}^{e'}(0) \bar{d}_{\beta'}^{e'}(0) \right] (\gamma_5)_{\alpha\beta} (\gamma_5)_{\beta'\alpha'}. \end{aligned} \quad (\text{F.10})$$

Taking contractions and imposing isospin symmetry as before we arrive at

$$\begin{aligned}
\langle 0 | \chi_{\pi^0}(x) \chi_{\pi^0}^\dagger(0) | 0 \rangle &= \frac{1}{2} \left[ D_{\beta\alpha}^{ee}(x, x) U_{\alpha'\beta'}^{e'e'}(0, 0) - D_{\beta\alpha}^{ee}(x, x) D_{\alpha'\beta'}^{e'e'}(0, 0) \right. \\
&\quad + D_{\beta\beta'}^{e'e'}(x, 0) D_{\alpha'\alpha}^{e'e}(0, x) - U_{\beta\alpha}^{ee}(x, x) U_{\alpha'\beta'}^{e'e'}(0, 0) \\
&\quad \left. + U_{\beta\beta'}^{e'e'}(x, 0) U_{\alpha'\alpha}^{e'e}(0, x) + U_{\beta\alpha}^{ee}(x, x) D_{\alpha'\beta'}^{e'e'}(0, 0) \right] (\gamma_5)_{\alpha\beta} (\gamma_5)_{\beta'\alpha'} \\
&= \frac{1}{2} \left[ S_{\beta\alpha}^{ee}(x, x) S_{\alpha'\beta'}^{e'e'}(0, 0) - S_{\beta\alpha}^{ee}(x, x) S_{\alpha'\beta'}^{e'e'}(0, 0) \right. \\
&\quad + S_{\beta\beta'}^{e'e'}(x, 0) S_{\alpha'\alpha}^{e'e}(0, x) - S_{\beta\alpha}^{ee}(x, x) S_{\alpha'\beta'}^{e'e'}(0, 0) \\
&\quad \left. + S_{\beta\beta'}^{e'e'}(x, 0) S_{\alpha'\alpha}^{e'e}(0, x) + S_{\beta\alpha}^{ee}(x, x) S_{\alpha'\beta'}^{e'e'}(0, 0) \right] (\gamma_5)_{\alpha\beta} (\gamma_5)_{\beta'\alpha'} \\
&= S_{\beta\beta'}^{e'e'}(x, 0) S_{\alpha'\alpha}^{e'e}(0, x) (\gamma_5)_{\alpha\beta} (\gamma_5)_{\beta'\alpha'} \\
&= S_{\alpha'\alpha}^{e'e}(0, x) (\gamma_5)_{\alpha\beta} S_{\beta\beta'}^{e'e'}(x, 0) (\gamma_5)_{\beta'\alpha'} \\
&= \text{Tr} [ S^{e'e}(0, x) (\gamma_5) S^{e'e'}(x, 0) (\gamma_5) ]. \tag{F.11}
\end{aligned}$$

As we can now see this two-point function is the same as the two-point function for  $\chi_{\pi^+}$  in equation (F.8). That is,

$$\langle 0 | \chi_{\pi^0}(x) \chi_{\pi^0}^\dagger(0) | 0 \rangle = \langle 0 | \chi_{\pi^+}(x) \chi_{\pi^+}^\dagger(0) | 0 \rangle. \tag{F.12}$$

Furthermore, it is clear that the correlation functions for  $\chi_{K^-} = \bar{u}^e(x) \gamma_5 s^e(x)$  and  $\chi_{\bar{K}^0} = \bar{d}^e(x) \gamma_5 s^e(x)$ , are identical upon imposing isospin symmetry. That is,

$$\langle 0 | \chi_{K^-}(x) \chi_{K^-}^\dagger(0) | 0 \rangle = \langle 0 | \chi_{\bar{K}^0}(x) \chi_{\bar{K}^0}^\dagger(0) | 0 \rangle. \tag{F.13}$$

It is also immediately obvious in the  $SU(3)$  flavour limit that the interpolators  $\chi_{\pi^+}$ ,  $\chi_{K^-}$  and  $\chi_{\bar{K}^0}$  are identical. We can therefore write (in the  $SU(3)$  flavour limit)

$$\begin{aligned}
\langle 0 | \chi_{K^-}(x) \chi_{K^-}^\dagger(0) | 0 \rangle &= \langle 0 | \chi_{\bar{K}^0}(x) \chi_{\bar{K}^0}^\dagger(0) | 0 \rangle \\
&= \langle 0 | \chi_{\pi^0}(x) \chi_{\pi^0}^\dagger(0) | 0 \rangle \\
&= \langle 0 | \chi_{\pi^+}(x) \chi_{\pi^+}^\dagger(0) | 0 \rangle. \tag{F.14}
\end{aligned}$$

Now turning our attention to the proton and  $\Lambda$ , we begin by calculating the correlation function for the proton. We therefore start with the interpolator  $\chi_3^p$ , given in table 3.1

$$\begin{aligned}
\chi_3^p(x) &= \frac{1}{\sqrt{2}} \epsilon^{abc} (u^{Ta}(x) (C \gamma_5) d^b(x)) u^c(x) \\
\bar{\chi}_3^p(x) &= -\frac{1}{\sqrt{2}} \epsilon^{a'b'c'} \bar{u}^{c'}(x) (\bar{d}^{b'}(x) (C \gamma_5) \bar{u}^{Ta'}(x)). \tag{F.15}
\end{aligned}$$

Hence,

$$\begin{aligned}
\chi_3^p(x)\bar{\chi}_3^p(0) &= -\frac{1}{2}\epsilon^{abc}\epsilon^{a'b'c'} \\
&\quad \times \left[ (u_\alpha^{Ta}(x)(C\gamma_5)_{\alpha\beta}d_\beta^b(x))u_\lambda^c(x)\bar{u}_{\lambda'}^{c'}(0)(\bar{d}_{\beta'}^{b'}(0)(C\gamma_5)_{\beta'\alpha'}\bar{u}_{\alpha'}^{T a'}(0)) \right] \\
&= -\frac{1}{2}\epsilon^{abc}\epsilon^{a'b'c'} \\
&\quad \times \left[ u_\alpha^{Ta}(x)d_\beta^b(x)u_\lambda^c(x)\bar{u}_{\lambda'}^{c'}(0)\bar{d}_{\beta'}^{b'}(0)\bar{u}_{\alpha'}^{T a'}(0)(C\gamma_5)_{\alpha\beta}(C\gamma_5)_{\beta'\alpha'} \right].
\end{aligned} \tag{F.16}$$

Then taking all possible contractions as before we obtain

$$\begin{aligned}
\langle 0|\chi_3^p(x)\bar{\chi}_3^p(0)|0\rangle &= -\frac{1}{2}\epsilon^{abc}\epsilon^{a'b'c'} \left[ U_{\alpha\alpha'}^{aa'}(x,0)U_{\lambda\lambda'}^{cc'}(x,0)D_{\beta\beta'}^{bb'}(x,0) \right. \\
&\quad \left. - U_{\alpha\lambda'}^{ac'}(x,0)U_{\lambda\alpha'}^{ca'}(x,0)D_{\beta\beta'}^{bb'}(x,0) \right] (C\gamma_5)_{\alpha\beta}(C\gamma_5)_{\beta'\alpha'} \\
&= -\frac{1}{2}\epsilon^{abc}\epsilon^{a'b'c'} \left[ U_{\lambda\lambda'}^{cc'}(x,0)(C\gamma_5)_{\alpha\beta}D_{\beta\beta'}^{bb'}(x,0)(C\gamma_5)_{\beta'\alpha'}U_{\alpha'\alpha}^{aa'T} \right. \\
&\quad \left. - U_{\lambda\alpha'}^{ca'}(x,0)(C\gamma_5)_{\alpha'\beta'}^T D_{\beta\beta'}^{bb'T}(x,0)(C\gamma_5)_{\beta\alpha}^T U_{\alpha\lambda'}^{ac'}(x,0) \right] \\
&= -\frac{1}{2}\epsilon^{abc}\epsilon^{a'b'c'} \left[ U^{cc'}(x,0)\text{Tr}[(C\gamma_5)D^{bb'}(x,0)(C\gamma_5)U^{aa'T}] \right. \\
&\quad \left. + U^{aa'}(x,0)(C\gamma_5)D^{bb'T}(x,0)(C\gamma_5)U^{cc'}(x,0) \right], \tag{F.17}
\end{aligned}$$

where we have picked up three signs on the final line for taking the transpose off two  $C\gamma_5$  and swapping  $a \leftrightarrow c$ . Turning our attention to the  $\Lambda$ , we start with the interpolator

$$\begin{aligned}
\chi_3^\Lambda(x) &= \frac{1}{\sqrt{6}}\epsilon^{abc} \left[ 2(u^{Ta}(x)(C\gamma_5)d^b(x))s^c(x) + (u^{Ta}(x)(C\gamma_5)s^b(x))d^c(x) \right. \\
&\quad \left. - (d^{Ta}(x)(C\gamma_5)s^b(x))u^c(x) \right], \tag{F.18}
\end{aligned}$$

and hence

$$\begin{aligned}
\bar{\chi}_3^\Lambda(x) &= -\frac{1}{\sqrt{6}}\epsilon^{a'b'c'} \left[ -\bar{u}^{c'}(x)(\bar{s}^{b'}(x)(C\gamma_5)\bar{d}^{T a'}(x)) + \bar{d}^{c'}(x)(\bar{s}^{b'}(x)(C\gamma_5)\bar{u}^{T a'}(x)) \right. \\
&\quad \left. + 2\bar{s}^{c'}(x)(\bar{d}^{b'}(x)(C\gamma_5)\bar{u}^{T a'}(x)) \right]. \tag{F.19}
\end{aligned}$$

Therefore,

$$\begin{aligned}
\chi_3^\Lambda(x)\bar{\chi}_3^\Lambda(0) &= -\frac{1}{6}\epsilon^{abc}\epsilon^{a'b'c'} \\
&\quad \left[ \left[ 2(u_\alpha^{Ta}(x)(C\gamma_5)_{\alpha\beta}d_\beta^b(x))s_\lambda^c(x) \right. \right.
\end{aligned}$$

$$\begin{aligned}
& + \left( u_\alpha^{T_a}(x)(C\gamma_5)_{\alpha\beta}s_\beta^b(x) \right) d_\lambda^c(x) \\
& \quad - \left( d_\alpha^{T_a}(x)(C\gamma_5)_{\alpha\beta}s_\beta^b(x) \right) u_\lambda^c(x) \Big] \\
& \quad \times \left[ - \bar{u}_{\lambda'}^{c'}(0) (\bar{s}_{\beta'}^{b'}(0)(C\gamma_5)_{\beta'\alpha'} \bar{d}_{\alpha'}^{T_{a'}}(0)) \right. \\
& \quad \quad + \bar{d}_{\lambda'}^{c'}(0) (\bar{s}_{\beta'}^{b'}(0)(C\gamma_5)_{\beta'\alpha'} \bar{u}_{\alpha'}^{T_{a'}}(0)) \\
& \quad \quad \left. + 2\bar{s}_{\lambda'}^{c'}(0) (\bar{d}_{\beta'}^{b'}(0)(C\gamma_5)_{\beta'\alpha'} \bar{u}_{\alpha'}^{T_{a'}}(0)) \right] \Big] \\
= & -\frac{1}{6} \epsilon^{abc} \epsilon^{a'b'c'} \left[ -2u_\alpha^{T_a}(x) d_\beta^b(x) s_\lambda^c(x) \bar{u}_{\lambda'}^{c'}(0) \bar{s}_{\beta'}^{b'}(0) \bar{d}_{\alpha'}^{T_{a'}}(0) \right. \\
& + 2u_\alpha^{T_a}(x) d_\beta^b(x) s_\lambda^c(x) \bar{d}_{\lambda'}^{c'}(0) \bar{s}_{\beta'}^{b'}(0) \bar{u}_{\alpha'}^{T_{a'}}(0) \\
& + 4u_\alpha^{T_a}(x) d_\beta^b(x) s_\lambda^c(x) \bar{s}_{\lambda'}^{c'}(0) \bar{d}_{\beta'}^{b'}(0) \bar{u}_{\alpha'}^{T_{a'}}(0) \\
& - u_\alpha^{T_a}(x) s_\beta^b(x) d_\lambda^c(x) \bar{u}_{\lambda'}^{c'}(0) \bar{s}_{\beta'}^{b'}(0) \bar{d}_{\alpha'}^{T_{a'}}(0) \\
& + u_\alpha^{T_a}(x) s_\beta^b(x) d_\lambda^c(x) \bar{d}_{\lambda'}^{c'}(0) \bar{s}_{\beta'}^{b'}(0) \bar{u}_{\alpha'}^{T_{a'}}(0) \\
& + 2u_\alpha^{T_a}(x) s_\beta^b(x) d_\lambda^c(x) \bar{s}_{\lambda'}^{c'}(0) \bar{d}_{\beta'}^{b'}(0) \bar{u}_{\alpha'}^{T_{a'}}(0) \\
& + d_\alpha^{T_a}(x) s_\beta^b(x) u_\lambda^c(x) \bar{u}_{\lambda'}^{c'}(0) \bar{s}_{\beta'}^{b'}(0) \bar{d}_{\alpha'}^{T_{a'}}(0) \\
& - d_\alpha^{T_a}(x) s_\beta^b(x) u_\lambda^c(x) \bar{d}_{\lambda'}^{c'}(0) \bar{s}_{\beta'}^{b'}(0) \bar{u}_{\alpha'}^{T_{a'}}(0) \\
& \left. - 2d_\alpha^{T_a}(x) s_\beta^b(x) u_\lambda^c(x) \bar{s}_{\lambda'}^{c'}(0) \bar{d}_{\beta'}^{b'}(0) \bar{u}_{\alpha'}^{T_{a'}}(0) \right] (C\gamma_5)_{\alpha\beta} (C\gamma_5)_{\beta'\alpha'}. \tag{F.20}
\end{aligned}$$

Then taking all possible contractions as before and going to the  $SU(3)$  flavour limit we have

$$\begin{aligned}
\langle 0 | \chi_3^\Lambda(x) \bar{\chi}_3^\Lambda(0) | 0 \rangle = & -\frac{1}{6} \epsilon^{abc} \epsilon^{a'b'c'} \left[ -2U_{\alpha\lambda'}^{ac'}(x, 0) D_{\beta\alpha'}^{ba'}(x, 0) S_{\lambda\beta'}^{cb'}(x, 0) \right. \\
& - 2U_{\alpha\alpha'}^{aa'}(x, 0) D_{\beta\lambda'}^{bc'}(x, 0) S_{\lambda\beta'}^{cb'}(x, 0) \\
& + 4U_{\alpha\alpha'}^{aa'}(x, 0) D_{\beta\beta'}^{bb'}(x, 0) S_{\lambda\lambda'}^{cc'}(x, 0) \\
& + U_{\alpha\lambda'}^{ac'}(x, 0) S_{\beta\beta'}^{bb'}(x, 0) D_{\lambda\alpha'}^{ca'}(x, 0) \\
& + U_{\alpha\alpha'}^{aa'}(x, 0) S_{\beta\beta'}^{bb'}(x, 0) D_{\lambda\lambda'}^{cc'}(x, 0) \\
& - 2U_{\alpha\alpha'}^{aa'}(x, 0) S_{\beta\lambda'}^{bc'}(x, 0) D_{\lambda\beta'}^{cb'}(x, 0) \\
& + D_{\alpha\alpha'}^{aa'}(x, 0) S_{\beta\beta'}^{bb'}(x, 0) U_{\lambda\lambda'}^{cc'}(x, 0) \\
& + D_{\alpha\lambda'}^{ac'}(x, 0) S_{\beta\beta'}^{bb'}(x, 0) U_{\lambda\alpha'}^{ca'}(x, 0) \\
& \left. - 2D_{\alpha\beta'}^{ab'}(x, 0) S_{\beta\lambda'}^{bc'}(x, 0) U_{\lambda\alpha'}^{ca'}(x, 0) \right] (C\gamma_5)_{\alpha\beta} (C\gamma_5)_{\beta'\alpha'}. \\
= & -\frac{1}{6} \epsilon^{abc} \epsilon^{a'b'c'} \left[ -2S_{\alpha\lambda'}^{ac'}(x, 0) S_{\beta\alpha'}^{ba'}(x, 0) S_{\lambda\beta'}^{cb'}(x, 0) \right. \\
& \left. - 4S_{\alpha\alpha'}^{aa'}(x, 0) S_{\beta\lambda'}^{bc'}(x, 0) S_{\lambda\beta'}^{cb'}(x, 0) \right]
\end{aligned}$$

$$\begin{aligned}
& + 6S_{\alpha\alpha'}^{aa'}(x, 0)S_{\beta\beta'}^{bb'}(x, 0)S_{\lambda\lambda'}^{cc'}(x, 0) \\
& + 2S_{\alpha\lambda'}^{ac'}(x, 0)S_{\beta\beta'}^{bb'}(x, 0)S_{\lambda\alpha'}^{ca'}(x, 0) \\
& - 2S_{\alpha\beta'}^{ab'}(x, 0)S_{\beta\lambda'}^{bc'}(x, 0)S_{\lambda\alpha'}^{ca'}(x, 0) \Big] (C\gamma_5)_{\alpha\beta}(C\gamma_5)_{\beta'\alpha'}.
\end{aligned} \tag{F.21}$$

We have, of course, denoted the propagator in the  $SU(3)$  flavour limit by  $S$ , as per our previous convention. We then obtain

$$\begin{aligned}
\langle 0|\chi_3^\Lambda(x)\bar{\chi}_3^\Lambda(0)|0\rangle & = -\frac{1}{6}\epsilon^{abc}\epsilon^{a'b'c'} \Big[ \\
& - 2S_{\lambda\beta'}^{cb'}(x, 0)(C\gamma_5)_{\beta'\alpha'}S_{\alpha'\beta}^{ba'T}(x, 0)(C\gamma_5)_{\beta\alpha}^TS_{\alpha\lambda'}^{ac'}(x, 0) \\
& - 4S_{\lambda\beta'}^{cb'}(x, 0)(C\gamma_5)_{\beta'\alpha'}S_{\alpha'\alpha}^{aa'T}(x, 0)(C\gamma_5)_{\alpha\beta}S_{\beta\lambda'}^{bc'}(x, 0) \\
& + 6S_{\lambda\lambda'}^{cc'}(x, 0)(C\gamma_5)_{\alpha\beta}S_{\beta\beta'}^{bb'}(x, 0)(C\gamma_5)_{\beta'\alpha'}S_{\alpha'\alpha}^{aa'T}(x, 0) \\
& + 2S_{\lambda\alpha'}^{ca'}(x, 0)(C\gamma_5)_{\alpha'\beta'}^TS_{\beta'\beta}^{bb'T}(x, 0)(C\gamma_5)_{\beta\alpha}^TS_{\alpha\lambda'}^{ac'}(x, 0) \\
& - 2S_{\lambda\alpha'}^{ca'}(x, 0)(C\gamma_5)_{\alpha'\beta'}^TS_{\beta'\alpha}^{ab'T}(x, 0)(C\gamma_5)_{\alpha\beta}S_{\beta\lambda'}^{bc'}(x, 0) \\
& = -\epsilon^{abc}\epsilon^{a'b'c'} \Big[ S^{cc'}(x, 0)\text{Tr}(C\gamma_5)S^{bb'}(x, 0)(C\gamma_5)S^{aa'T}(x, 0) \\
& + S^{aa'}(x, 0)(C\gamma_5)S^{bb'T}(x, 0)(C\gamma_5)S^{cc'}(x, 0) \Big],
\end{aligned} \tag{F.22}$$

where we have taken the transpose off  $C\gamma_5$  for a sign and performed colour index relabeling on the final line. We can see that this is in the same form as the three quark proton two-point function given in (F.17).



# Bibliography

- [1] K. G. Wilson, *Confinement of Quarks*, Phys. Rev. **D10**, 2445-2459 (1974).
- [2] CLAS Collaboration, R. W. Gothe, *The nucleon resonance program at JLab*, AIP Conf. Proc **814** (2006) 278.
- [3] W. Melnitchouk *et al.*, *Excited baryons in lattice QCD*, Phys. Rev. D **67**, 114506 (2003) [arXiv:hep-lat/0202022].
- [4] N. Mathur *et al.*, *Roper resonance and  $S(11)(1535)$  from lattice QCD*, Phys. Lett. B **605**, 137 (2005) [arXiv:hep-ph/0306199].
- [5] D. Guadagnoli, M. Papinutto and S. Simula, *Extracting excited states from lattice QCD: The Roper resonance*, Phys. Lett. B **604**, 74 (2004) [arXiv:hep-lat/0409011].
- [6] S. Sasaki, *Latest results from lattice QCD for the Roper resonance*, Prog. Theor. Phys. Suppl. **151**, 143 (2003) [arXiv:nucl-th/0305014].
- [7] D. G. Richards, M. Gockeler, R. Horsley, D. Pleiter, P. E. L. Rakow, G. Schierholz and C. M. Maynard [LHPC Collaboration and QCDSF Collaboration and UKQCD Collaboration], *Excited nucleon spectrum using a non-perturbatively improved clover fermion action*, Nucl. Phys. Proc. Suppl. **109A**, 89 (2002) [arXiv:hep-lat/0112031].
- [8] C. M. Maynard and D. G. Richards [UKQCD Collaboration and LHP Collaboration], *Excitations of the nucleon with dynamical fermions*, Nucl. Phys. Proc. Suppl. **119**, 287 (2003) [arXiv:hep-lat/0209165].
- [9] B. J. Menadue, W. Kamleh, D. B. Leinweber and M. S. Mahbub, *Isolating the  $\Lambda(1405)$  in Lattice QCD*, arXiv:1109.6716 [hep-lat].
- [10] B. G. Lasscock, J. N. Hedditch, W. Kamleh, D. B. Leinweber, W. Melnitchouk, A. G. Williams and J. M. Zanotti, *Even parity excitations of the*

- nucleon in lattice QCD*, Phys. Rev. D **76**, 054510 (2007) [arXiv:0705.0861 [hep-lat]].
- [11] D. B. Leinweber, W. Melnitchouk, D. G. Richards, A. G. Williams, J. M. Zanotti, *Baryon spectroscopy in lattice QCD*, Lect. Notes Phys. **663**, 71-112 (2005). [nucl-th/0406032].
- [12] M. S. Mahbub, A. O. Cais, W. Kamleh, D. B. Leinweber and A. G. Williams, *Positive-parity Excited-states of the Nucleon in Quenched Lattice QCD*, Phys. Rev. D **82**, 094504 (2010) [arXiv:1004.5455 [hep-lat]].
- [13] M. S. Mahbub, A. O. Cais, W. Kamleh, B. G. Lasscock, D. B. Leinweber and A. G. Williams, *Isolating the Roper Resonance in Lattice QCD*, Phys. Lett. B **679**, 418 (2009) [arXiv:0906.5433 [hep-lat]].
- [14] M. S. Mahbub, A. O. Cais, W. Kamleh, B. G. Lasscock, D. B. Leinweber and A. G. Williams, *Isolating Excited States of the Nucleon in Lattice QCD*, Phys. Rev. D **80**, 054507 (2009) [arXiv:0905.3616 [hep-lat]].
- [15] S. Sasaki, T. Blum and S. Ohta, *A lattice study of the nucleon excited states with domain wall fermions*, Phys. Rev. D **65**, 074503 (2002) [arXiv:hep-lat/0102010].
- [16] M. Lüscher, Commun. Math. Phys. **105** (1986) 153.
- [17] M. Lüscher, Nucl. Phys. B **354** (1991) 531.
- [18] M. Lüscher, Nucl. Phys. B **364** (1991) 237.
- [19] P. Giudice and M. J. Peardon, *Hadronic decay width from finite-volume energy spectrum in lattice QCD*, AIP Conf. Proc. **1257**, 784 (2010) [arXiv:1010.1390 [hep-lat]].
- [20] B. J. Menadue, W. Kamleh, D. B. Leinweber and M. S. Mahbub, *Extracting Low-Lying Lambda Resonances Using Correlation Matrix Techniques*, AIP Conf. Proc. **1354**, 213 (2011) [arXiv:1102.3492 [hep-lat]].
- [21] M. S. Mahbub, W. Kamleh, D. B. Leinweber, P. J. Moran and A. G. Williams [CSSM Lattice collaboration], *Roper Resonance in 2+1 Flavor QCD*, arXiv:1011.5724 [hep-lat].

- [22] C. Amsler, et al., Phys. Lett. B667 (2008) 1. doi:10.1016/j.physletb.2008.07.018.
- [23] C. Gattringer, C. B. Lang, *Quantum Chromodynamics on the Lattice* (Springer 2010)
- [24] W. Kamleh, *Lattice Quantum Chromodynamics with FLIC Overlap Fermions*, PhD Thesis, (University of Adelaide 2004)
- [25] P. J. Moran, *Impact of Dynamical Fermions on the Vacuum of Quantum Chromodynamics*, PhD Thesis, (University of Adelaide 2004)
- [26] H. J. Rothe, *Lattice Gauge Theories: An Introduction* (World Scientific 1992)
- [27] F. A. Berezin, *The Method of Second Quantization* (Academic Press, New York, 1966)
- [28] T. Mathews and A.Salam: Nuovo Cim. **12**, 563 (1954)
- [29] T. Mathews and A.Salam: Nuovo Cim. **2**, 120 (1955)
- [30] R. M. Woloshyn, *An Overview of Lattice QCD* (1988), lectures given at Lake Louise Winter Inst., Lake Louise, Canada, Mar 6-12, 1988
- [31] C. R. Allton *et al.* [UKQCD Collaboration], *Quenched Hadrons Using Wilson And  $O(A)$  Improved Fermion Actions At  $\beta = 6.2$* , Phys. Lett. B **284**, 377 (1992) [arXiv:hep-lat/9205016].
- [32] C. R. Allton *et al.* [UKQCD Collaboration], *The Light hadron spectrum and decay constants in quenched lattice QCD*, Phys. Rev. D **49**, 474 (1994) [arXiv:hep-lat/9309002].
- [33] C. R. Allton *et al.* [UKQCD Collaboration], *Quenched light hadron mass spectrum and decay constants: The Effects of  $O(a)$  improvement at  $\beta = 6.2$* , Nucl. Phys. B **407**, 331 (1993) [arXiv:hep-lat/9307009].
- [34] H. Neuberger, *Bounds on the Wilson Dirac operator*, Phys. Rev. D **61**, 085015 (2000) [arXiv:hep-lat/9911004].
- [35] H. B. Nielsen and M. Ninomiya, *No Go Theorem For Regularizing Chiral Fermions*, Phys. Lett. B **105**, 219 (1981).

- [36] H. B. Nielsen and M. Ninomiya, *Absence Of Neutrinos On A Lattice. 1. proof by homotopy theory*, Nucl. Phys. B **185**, 20 (1981).
- [37] H. B. Nielsen and M. Ninomiya, *Absence Of Neutrinos On A Lattice. 2. Intuitive Topological Proof*, Nucl. Phys. B **193**, 173 (1981).
- [38] T. DeGrand, C. DeTar, *Lattice Methods For Quantum Chromodynamics* (World Scientific 2006)
- [39] H. Neuberger, *Exact chiral symmetry on the lattice*, Ann. Rev. Nucl. Part. Sci. **51**, 23 (2001) [arXiv:hep-lat/0101006].
- [40] B. Sheikholeslami and R. Wohlert, *Improved Continuum Limit Lattice Action For QCD With Wilson Fermions*, Nucl. Phys. B **259**, 572 (1985).
- [41] F. D. R. Bonnet, P. Fitzhenry, D. B. Leinweber, M. R. Stanford and A. G. Williams, *Calibration of smearing and cooling algorithms in SU(3)-color gauge theory*, Phys. Rev. D **62**, 094509 (2000) [arXiv:hep-lat/0001018].
- [42] S. O. Bilson-Thompson, D. B. Leinweber and A. G. Williams, *Highly-improved lattice field-strength tensor*, Annals Phys. **304**, 1 (2003) [arXiv:hep-lat/0203008].
- [43] W. Kamleh, B. Lasscock, D. B. Leinweber and A. G. Williams, *Scaling analysis of FLIC fermion actions* Phys. Rev. D **77**, 014507 (2008) [arXiv:0709.1531 [hep-lat]].
- [44] G. P. Lepage and P. B. Mackenzie, *On The Viability Of Lattice Perturbation Theory*, Phys. Rev. D **48**, 2250 (1993) [arXiv:hep-lat/9209022].
- [45] T. A. DeGrand, A. Hasenfratz and T. G. Kovacs [MILC Collaboration], *Optimizing the chiral properties of lattice fermion actions*, arXiv:hep-lat/9807002.
- [46] W. A. Bardeen, A. Duncan, E. Eichten, G. Hockney and H. Thacker, *Light quarks, zero modes, and exceptional configurations*, Phys. Rev. D **57**, 1633 (1998) [arXiv:hep-lat/9705008].
- [47] J. M. Zanotti *et al.* [CSSM Lattice Collaboration], *Hadron Masses From Novel Fat-Link Fermion Actions*, Phys. Rev. D **65**, 074507 (2002) [arXiv:hep-lat/0110216].

- [48] M. G. Alford, T. R. Klassen and G. P. Lepage, *Improving lattice quark actions*, Nucl. Phys. B **496**, 377 (1997) [arXiv:hep-lat/9611010].
- [49] T. A. DeGrand [MILC collaboration], *Simple observables from fat link fermion actions*, Phys. Rev. D **60**, 094501 (1999) [arXiv:hep-lat/9903006].
- [50] M. Falcioni, M. L. Paciello, G. Parisi and B. Taglienti, *Again On SU(3) Glueball Mass*, Nucl. Phys. B **251**, 624 (1985).
- [51] F. D. R. Bonnet, D. B. Leinweber, A. G. Williams and J. M. Zanotti, *Improved smoothing algorithms for lattice gauge theory*, Phys. Rev. D **65**, 114510 (2002) [arXiv:hep-lat/0106023].
- [52] M. C. Chu, J. M. Grandy, S. Huang and J. W. Negele, *Evidence for the role of instantons in hadron structure from lattice QCD*, Phys. Rev. D **49**, 6039 (1994) [arXiv:hep-lat/9312071].
- [53] C. Morningstar, M. Peardon, Phys. Rev. D **69**, 054501 (2004) *Analytic smearing of SU(3) link variables in lattice QCD*
- [54] Makeenko, Y., *Methods of Contemporary Gauge Theory* (Cambridge University Press, Cambridge, 2002) Part 2: Chpt 6
- [55] M. Luscher and P. Weisz, *On-Shell Improved Lattice Gauge Theories*, Commun. Math. Phys. **97**, 59 (1985) [Erratum-ibid. **98**, 433 (1985)].
- [56] M. Luscher and P. Weisz, *Computation Of The Action For On-Shell Improved Lattice Gauge Theories At Weak Coupling*, Phys. Lett. B **158**, 250 (1985).
- [57] Y. Iwasaki, *Renormalization Group Analysis Of Lattice Theories And Improved Lattice Action. 2. Four-Dimensional Nonabelian SU(N) Gauge Model*,
- [58] T. Takaishi, *Heavy quark potential and effective actions on blocked configurations*, Phys. Rev. D **54**, 1050 (1996).
- [59] P. de Forcrand *et al.* [QCD-TARO Collaboration], *Renormalization group flow of SU(3) lattice gauge theory: Numerical studies in a two coupling space*, Nucl. Phys. B **577**, 263 (2000) [arXiv:hep-lat/9911033].
- [60] A. Borici and R. Rosenfelder, *Scaling in SU(3) theory with a MCRG improved lattice action*, Nucl. Phys. Proc. Suppl. **63**, 925 (1998) [arXiv:hep-lat/9711035].

- [61] P. de Forcrand *et al.* [QCD-TARO Collaboration], *Search for effective lattice action of pure QCD*, Nucl. Phys. Proc. Suppl. **53**, 938 (1997) [arXiv:hep-lat/9608094].
- [62] B. G. Lasscock *et al.*, *Search for the pentaquark resonance signature in lattice QCD*, Phys. Rev. D **72**, 014502 (2005) [arXiv:hep-lat/0503008].
- [63] Lecture Notes in Physics, *Lattice Hadron Physics* (Springer 2005)
- [64] J. D. Bjorken, S. D. Drell, *Relativistic Quantum Mechanics*, (McGraw-Hill 1964).
- [65] B. Efron, R. J. Tibshirani, *An introduction to the Bootstrap*. (Chapman and Hall 1993)
- [66] D. B. Leinweber, *Nucleon properties from unconventional interpolating fields*, Phys. Rev. D **51**, 6383 (1995) [arXiv:nucl-th/9406001].
- [67] D. B. Leinweber, R. M. Woloshyn and T. Draper, *Electromagnetic structure of octet baryons*, Phys. Rev. D **43**, 1659 (1991).
- [68] J. N. Hedditch, W. Kamleh, B. G. Lasscock, D. B. Leinweber, A. G. Williams and J. M. Zanotti,  *$1^{-+}$  exotic meson at light quark masses*, Phys. Rev. D **72**, 114507 (2005) [arXiv:hep-lat/0509106].
- [69] A. Frommer, V. Hannemann, B. Nockel, T. Lippert and K. Schilling, *Accelerating Wilson fermion matrix inversions by means of the stabilized biconjugate gradient algorithm*, Int. J. Mod. Phys. C **5**, 1073 (1994) [arXiv:hep-lat/9404013].
- [70] J. Foley, K. Jimmy Juge, A. O’Cais, M. Peardon, S. M. Ryan and J. I. Skullerud, *Practical all-to-all propagators for lattice QCD*, Comput. Phys. Commun. **172**, 145 (2005) [arXiv:hep-lat/0505023].
- [71] C. Alexandrou, D. Christaras, A. O’Cais and A. Strelchenko, *Exact calculation of disconnected loops*, PoS **LATTICE2010**, 035 (2010) [arXiv:1012.5168 [hep-lat]].
- [72] S. J. Dong and K. F. Liu, *Stochastic estimation with  $Z(2)$  noise*, Phys. Lett. B **328**, 130 (1994) [arXiv:hep-lat/9308015].

- [73] S. Bernardson, P. McCarty and C. Thron, *Monte Carlo methods for estimating linear combinations of inverse matrix entries in lattice QCD*, Comput. Phys. Commun. **78**, 256 (1993).
- [74] J. Bulava, R. Edwards and C. Morningstar [HADRON SPECTRUM Collaboration], *Stochastic All-to-All Propagators for Baryon Correlators*, PoS **LATTICE2008**, 124 (2008) [arXiv:0810.1469 [hep-lat]].
- [75] C. Morningstar, A. Bell, J. Bulava, J. Foley, K. J. Juge, D. Lenkner and C. H. Wong, *Excited-State Hadrons using the Stochastic LapH Method*, AIP Conf. Proc. **1354**, 97 (2011) [arXiv:1101.5398 [hep-lat]].
- [76] J. Foley, C. H. Wong, J. Bulava, K. J. Juge, D. Lenkner, C. Morningstar and M. Peardon, *A novel method for evaluating correlation functions in lattice hadron spectroscopy*, arXiv:1011.0481 [hep-lat].
- [77] C. Morningstar *et al.*, *The excited hadron spectrum in lattice QCD using a new variance reduction method*, PoS **ICHEP2010**, 369 (2010) [arXiv:1011.6573 [hep-lat]].
- [78] A. O’Cais, K. J. Juge, M. J. Peardon, S. M. Ryan and J. I. Skullerud [TrinLat Collaboration], *Improving algorithms to compute all elements of the lattice quark propagator*, arXiv:hep-lat/0409069.
- [79] S. Duane, A. D. Kennedy, B. J. Pendleton and D. Roweth, *Hybrid Monte Carlo*, Phys. Lett. B **195**, 216 (1987).
- [80] T. Doi, N. Ishii, M. Oka and H. Suganuma, Phys. Rev. D **67**, 054504 (2003) [arXiv:hep-lat/0211039].
- [81] T. Doi, N. Ishii, M. Oka and H. Suganuma, Nucl. Phys. A **721**, 934 (2003) [arXiv:hep-lat/0212006].
- [82] M. Foster and C. Michael [UKQCD Collaboration], Phys. Rev. D **59**, 074503 (1999) [arXiv:hep-lat/9810021].
- [83] J. J. Sakurai, *Advanced Quantum Mechanics*, (Addison-Wesley Publishing Company 1967).
- [84] D. J. Griffiths, *Introduction to Quantum Mechanics*, (Pearson Prentice Hall 2005).

- [85] M. E. Peskin, D. V. Schroeder, *An Introduction to Quantum Field Theory*, (Addison-Wesley Publishing Company 1995).